

**eko  
okna**

**INTERIOR DOOR  
CATALOGUE**

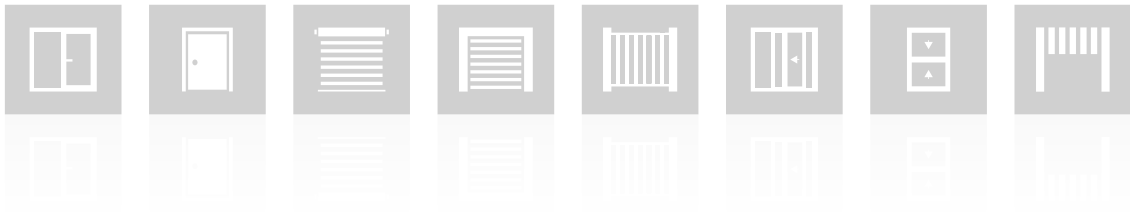

1/2023



Eko-Okna S.A. is an international manufacturer of windows and doors made of PVC, aluminium, steel and wood. On the market since 1998. Production takes place in five production halls, equipped with the most modern, fully automated production lines. The production process is supported by qualified and experienced staff. We focus on development and innovation. Our offer is constantly expanding. Our wide offer also includes sliding systems, roller shutters, sectional doors, mosquito nets, and property fences. Everything is of the highest quality, because we use only high-quality materials from the best European suppliers.

We guarantee safety and durability. We operate based on ISO 9001 quality management systems. Each of our products is CE marked. We are aware that the basis of good business relations is open communication. Drawing on many years of experience, we have created a company that definitely stands out from other competitors in this respect. For our clients, we have at our disposal multilingual teams of qualified advisors and regional supervisors. We consider each inquiry, project or order individually so as to best meet the expectations of our customers.

Therefore, now, opening up to your expectations, we are introducing to our offer interior doors from the renowned Polish manufacturer Erkado. The doors from our offer are characterized by original and interesting design as well as very good quality of finish and attention to details.



# CONTENTS

<b>STILE DOORS</b>		<b>07</b>
Miskant	08	Fragi
Laurencja	10	Surmia
Budleja	12	Powojnik
Aralia Nolina Ewodia	14	Petunia
Epimedium	16	Orchidea
Magnolia	18	Lawenda
Irys	20	Krokus
Degleżja	22	Juka
Freżja	24	Hiacynt
Nemeżja	26	Forsycja
Berberys	28	Debecja
Floks	30	Azalia
Kamelia	32	
<b>STILE DOORS</b>		<b>58</b>
Miskant	58	Milda
Turan	60	Baldur
Laurencja	62	Sylena
Nemeżja	64	Anubis
Uno Premium	66	
<b>INLAYS</b>		<b>76</b>
<b>FLUSH DOORS</b>		<b>78</b>
Uno Premium	78	Sorano
Baldur	80	Ansedonia
Altawalla	82	Menton
Lorient	84	
<b>GLASS DOORS</b>		<b>92</b>
<b>INTERIOR FRONT DOORS</b>		<b>98</b>
<b>HERSE SET</b>		<b>98</b>
<b>FIXED AND ADJUSTABLE DOOR FRAME FOR HERSE SET SERIES</b>		<b>102</b>
<b>TECHNICAL INFORMATION</b>		<b>104</b>
<b>SLIDING DOOR SYSTEMS</b>		<b>112</b>
<b>DOUBLE DOORS</b>		<b>124</b>
<b>COVERT CONCEALED DOOR SYSTEM</b>		<b>128</b>
<b>DRE DOORS</b>		<b>142</b>
Estra	142	Uni
Auri	144	Fargo
Vetro A	146	Binito
Vetro B	148	Standard
Vetro D	150	Modern
Nova	152	Plus
Galeria Alu	154	
<b>DOORS WITH VARIABLE HEIGHTS</b>		<b>168</b>
Standard 10	168	
Plus	170	
Modern	172	
<b>TECHNICAL INFORMATION</b>		<b>174</b>
<b>FLUSH DOORS</b>		<b>78</b>
Fixed rebated door frames	183	Adjustable non-rebated door frames
Fixed non-rebated door frames	184	Adjustable non-rebated door frames with variable heights
Adjustable door frames	185	Adjustable door frames with inverted rebate
Adjustable door frames with variable heights	186	Adjustable tunnel
<b>DOORS WITH HIDDEN DOOR FRAME SARA ECO 2</b>		<b>192</b>
<b>DOOR SASHES WITH SOUND INSULATION RATE ENTER AKUSTIK 32 Db</b>		<b>192</b>
<b>FIXED REBATED DOOR FRAME AND ADJUSTABLE DOOR FRAME FOR ENTER AKUSTIK SERIES</b>		<b>197</b>
<b>SLIDING DOOR SYSTEMS</b>		<b>200</b>
<b>HARDWARE – HANDLES</b>		<b>200</b>

# DECORS

COLOURS AVAILABLE FOR INTERIOR DOORS

## GREKO

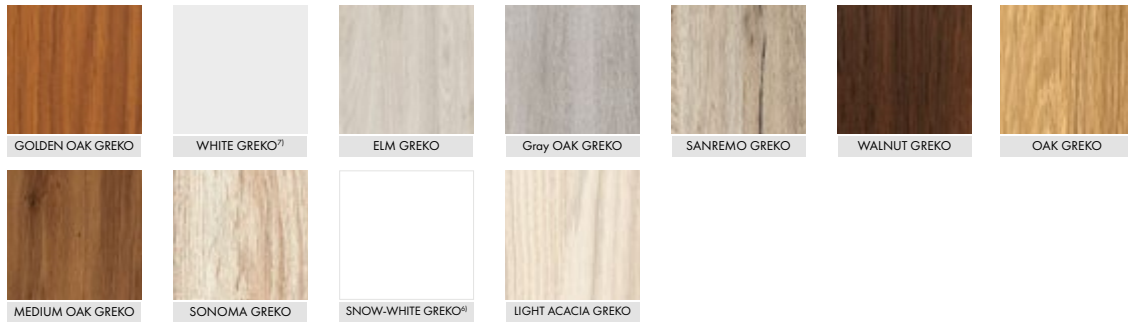

## PREMIUM

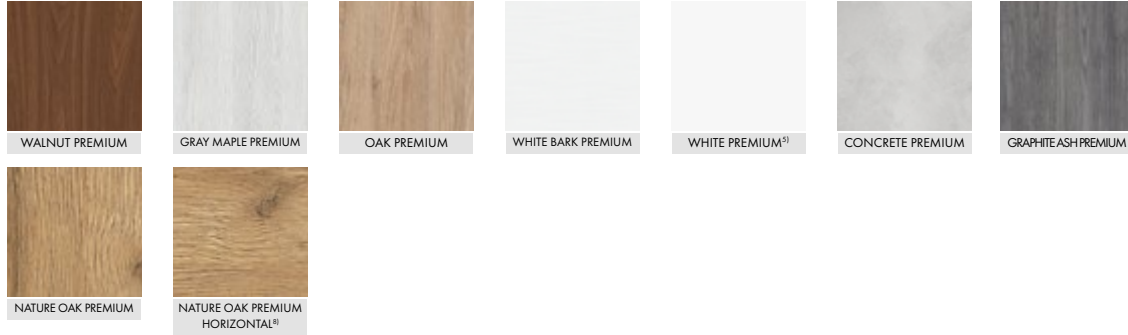

## CPL

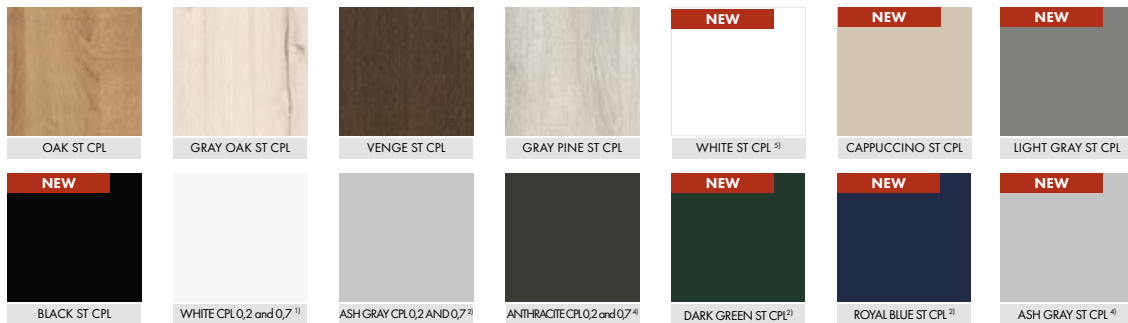

## UV-PAINTED

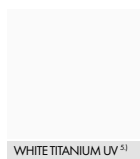

<sup>1)</sup> Similar to: RAL 9003, NCS S 0300-N), <sup>2)</sup> Similar to: RAL 7047, NCS S2500-N, <sup>4)</sup> Similar to: RAL D2 000 35 00 NCS S7000-N, <sup>5)</sup> Similar to: RAL 9003, NCS S0500-N, <sup>6)</sup> Similar to: RAL 9016, NCS S 0300-N <sup>7)</sup> Similar to: RAL 9010, NCS S 0502-Y50R, <sup>8)</sup> Comes complete with the Nature OAK PREMIUM door frame

Special **AntiFinger** coating to reduce dirt and fingerprints.

# STILE DOORS



## MDF STILES

- MDF stile for the GREKO, PREMIUM and CPL facings



## COLORS

- Attractive GREKO laminatee, resistant CPL facing or PREMIUM facing which is both good-looking and durable

## GLAZING

- Tempered and frosted or optionally: clear and novel VSG glass: mat or black **NEW**
- Aesthetic frameless tongue-and-groove glazing without bars, Solid 35 mm or 22 mm thick rail



## VENTILATION

- Three types of ventilation: sleeves , Grilles or Air gap undercut.

## DOOR FRAMES

- You can choose a fixed, adjustable frame with a 6 cm or 8 cm architrave.



\*ONLY REBATED DOOR Sashes

## AVAILABLE SYSTEMS

### REBATED DOOR

- 3 two-piece adjustable hinges
- classic door lock
- rebated door sash



### NON-REBATED DOORS

- 3 hidden hinges with 3D adjustment
- magnetic lock
- sash flushed with the frame

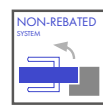

# MISKANT

REBATED AND NON-REBATED INTERIOR STILE DOORS

NEW



MISKANT 2 Nature PREMIUM OAK decor door sash, BLACK ST CPL decor door frame, BELLA slim black matt door handle

## SOLUTIONS AVAILABLE

PL

PL Standard

CZ

CZ Standard

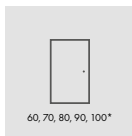

60, 70, 80, 90, 100\*

single-sash door

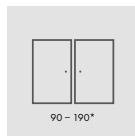

90 - 190\*

double doors

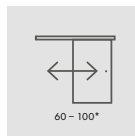

60 - 100\*

single-sash  
sliding door

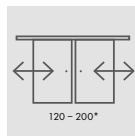

120 - 200\*

double-sash  
sliding door

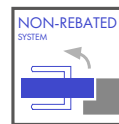

NON-REBATED  
SYSTEM

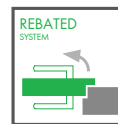

REBATED  
SYSTEM

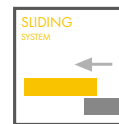

SLIDING  
SYSTEM

### AVAILABLE DOOR SASH WIDTHS

60 70 80 90 100

### MDF STILE

for GREKO, PREMIUM and CPL veneers



### STANDARD GLAZING "OBVERSE"



### CUSTOM GLAZING "REVERSE"





## CONSTRUCTION

- Rebated or non-rebated door sash made in STILE technology.
- MDF stiles and rails covered with the GREKO, PREMIUM, ST CPL facings or ST CPL laminatee with the AntiFinger coating. **NEW**

## HARDWARE

- 3 silver 2-pin hinges adjustable in the horizontal plane in the rebated door sash.
- 3 hinges hidden in the non-rebated door sash in silver (optionally in black for an extra charge); hinges are delivered and priced with the door frame.
- A lever tumbler lock in the rebated door sash and a magnetic lock in the non-rebated door sash, key-operated, cylinder lock, economy lock or with a silver blockade; optional black magnetic lock for an extra charge.

## GLAZING

- Frosted tempered glass (MISKANT 2, 4, 6) or transparent glass, 4 mm thick (MISKANT 1, 3, 5).
- Possibility of changing the glazing side to REVERSE (OBVERSE standard glazing).
- Black lines with a width (thickness) of 18 mm, painted in screen printing technology on one side of the glass.



Black lines, 18mm wide, painted in screen printing technology

### GREKO

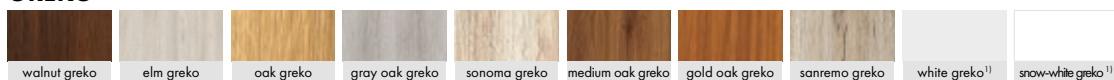

### PREMIUM



### CPL



### EXTRA CHARGE

Ventilation undercut or recuperation shortcut.

Wood-like plastic sleeves (4 pcs.).

Round and square metal sleeves (4 pcs.) brushed nickel, patina, white and black finish.

Ventilation grille (only for door sash widths: 80, 90, 100).

Rebated and non-rebated "100" door sash.

Drop down gasket.

Metal covers for hinges in the rebated door sash (colour: brushed nickel, patina, glossy chrome, glossy brass, white and black)

Replaced with a black magnetic lock for non-rebated door sashes.

VSG laminated glass with an internal application in black or white.

<sup>1)</sup> Smooth white veneer imitating painted surface. <sup>2)</sup> Special AntiFinger **NEW** coating to reduce dirt and fingerprints.

# LAURENCJA

REBATED AND NON-REBATED INTERIOR STILE DOORS



LAURENCJA 1, WHITE PREMIUM decor, black VSG glass, CUBE PREMIUM black matt door handle

## SOLUTIONS AVAILABLE

PL

PL Standard

CZ

CZ Standard

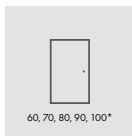

60, 70, 80, 90, 100\*

single-sash door

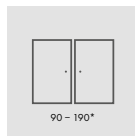

90 - 190\*

double doors

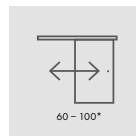

60 - 100\*

single-sash  
sliding door

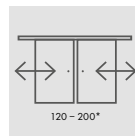

120 - 200\*

double-sash  
sliding door

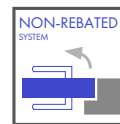

NON-REBATED  
SYSTEM

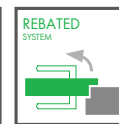

REBATED  
SYSTEM

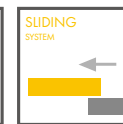

SLIDING  
SYSTEM

AVAILABLE **DOOR SASH WIDTHS**

60

70

80

90

100

### MDF STILE

for GREKO, PREMIUM and CPL veneers



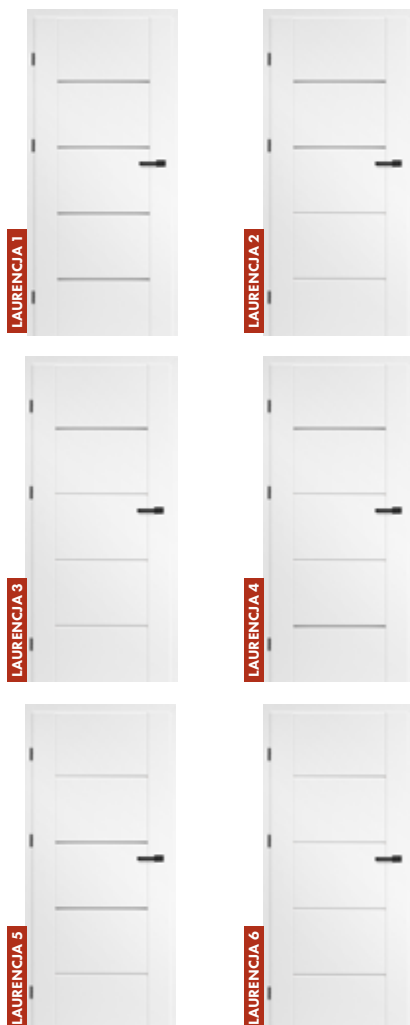

## CONSTRUCTION

- Rebated or non-rebated door sash made in STILE technology.
- Vertical and horizontal MDF stiles covered with PREMIUM, ST CPL or ST CPL veneer with AntiFinger coating. **NEW**
- HDF boards, 4 mm thick, covered with CPL or Premium veneer.
- Very wide crossbar th. 35mm.

## HARDWARE

- 3 silver 2-pin hinges adjustable in the horizontal plane in the rebated door sash.
- 3 hinges hidden in the non-rebated door sash in silver (optionally in black for an extra charge); hinges are delivered and priced with the door frame.
- A lever tumbler lock in the rebated door sash and a magnetic lock in the non-rebated door sash, key-operated, cylinder lock, economy lock or silver-coloured blockade; optional black magnetic lock for an extra charge.

## GLAZING

- Standard frosted or transparent 4 mm tempered glass and VSG 221 laminated glass, safety glass, smooth on both sides, available at an extra charge.
- Possibility of changing the glazing side to REVERSE (OBVERSE standard glazing).

### PREMIUM



### CPL



### EXTRA CHARGE

Ventilation undercut or recuperation shortcut.

Wood-like plastic sleeves (4 pcs.).

Round and square metal sleeves (4 pcs.) brushed nickel, patina, white and black finish.

Ventilation grille (only for door sash widths: 80, 90, 100).

Rebated and non-rebated "100" door sash.

Drop down gasket.

VSG 221 laminated glass, frosted glass or black safety glass, smooth on both sides.

Metal covers for hinges in the rebated door sash (colour: brushed nickel, patina, glossy chrome, glossy brass, white and black).

Replaced with a black magnetic lock for non-rebated door sashes.

<sup>1)</sup> Smooth white veneer imitating painted surface. <sup>2)</sup> Special **AntiFinger** **NEW** coating to reduce dirt and fingerprints.

# BUDLEJA

REBATED AND NON-REBATED INTERIOR STILE DOORS



BUDLEJA 2, OAK ST CPL decor, TOPAZ INOX door handle

## SOLUTIONS AVAILABLE

PL

PL Standard

CZ

CZ Standard

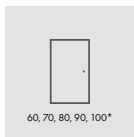

60, 70, 80, 90, 100\*

single-sash door

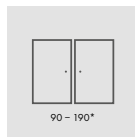

90 - 190\*

double doors

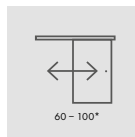

60 - 100\*

single-sash  
sliding door

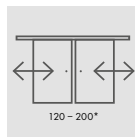

120 - 200\*

double-sash  
sliding door

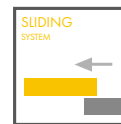
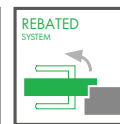
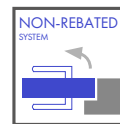

AVAILABLE **DOOR SASH WIDTHS**

60

70

80

90

100

**MDF STILE**

for GREKO, PREMIUM and CPL veneers





## CONSTRUCTION

- Rebated or non-rebated door sash made in STILE technology.
- Vertical and horizontal MDF stiles covered with PREMIUM, ST CPL or ST CPL veneer with AntiFinger coating. **NEW**
- Very wide crossbar th. 35mm.

## HARDWARE

- 3 silver 2-pin hinges adjustable in the horizontal plane in the rebated door sash.
- 3 hinges hidden in the non-rebated door sash in silver (optionally in black for an extra charge); hinges are delivered and priced with the door frame.
- A lever tumbler lock in the rebated door sash and a magnetic lock in the non-rebated door sash, key-operated, cylinder lock, economy lock or silver-coloured blockade; optional black magnetic lock for an extra charge.

## GLAZING

- Standard frosted or transparent 4 mm tempered glass and VSG 221 laminated glass, safety glass, smooth on both sides, available at an extra charge.
- Possibility of changing the glazing side to REVERSE (OBSERVE standard glazing).

### PREMIUM



### CPL



### EXTRA CHARGE

Ventilation undercut or recuperation shortcut.

Wood-like plastic sleeves (4 pcs.).

Round and square metal sleeves (4 pcs.) brushed nickel, patina, white and black finish.

Ventilation grille (only for door sash widths: 80, 90, 100).

Rebated and non-rebated \*100\* door sash.

Drop down gasket.

VSG 221 laminated glass, frosted glass or black safety glass, smooth on both sides.

- BUDLEJA 1
- BUDLEJA 2,4,6,8
- BUDLEJA 3,7
- BUDLEJA 5

Metal covers for hinges in the rebated door sash (colour: brushed nickel, patina, glossy chrome, glossy brass, white and black).

Replaced with a black magnetic lock for non-rebated door sashes.

<sup>1)</sup> Smooth white veneer imitating painted surface. <sup>2)</sup> Special **AntiFinger** **NEW** coating to reduce dirt and fingerprints.

# ARALIA NOLINA EWODIA

REBATED AND NON-REBATED INTERIOR STILE DOORS



ARALIA 1, KORA WHITE PREMIUM decor, RUMBA antibacterial black handle

## SOLUTIONS AVAILABLE

**PL**

PL Standard

**CZ**

CZ Standard

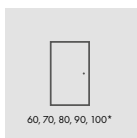

single-sash door

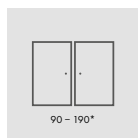

double doors

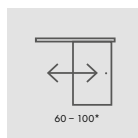

single-sash sliding door

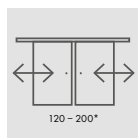

double-sash sliding door

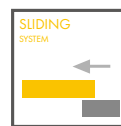
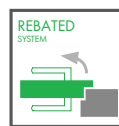
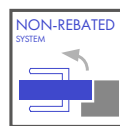

AVAILABLE **DOOR SASH WIDTHS**

60

70

80

90

100

**MDF STILE**

for GREKO, PREMIUM and CPL veneers



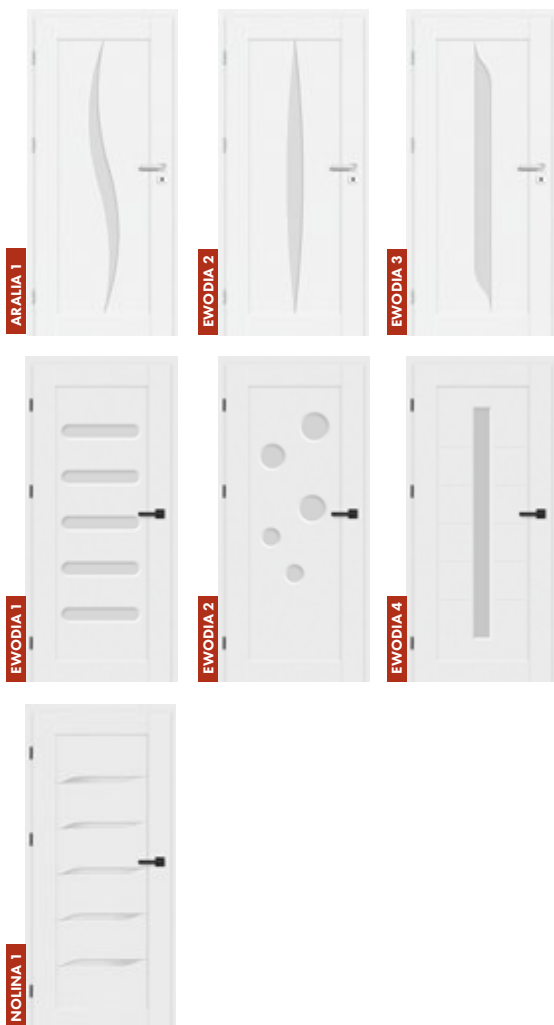

## PREMIUM



## EXTRA CHARGE

Ventilation undercut or recuperation shortcut.

Wood-like plastic sleeves (4 pcs.).

Round and square metal sleeves (4 pcs.) brushed nickel, patina, white and black finish.

Ventilation grille (only for door sash widths: 80, 90, 100).

Rebated and non-rebated "100" door sash.

Drop down gasket.

## CONSTRUCTION

- Rebated or non-rebated door sash made in STILE technology.
- Vertical and horizontal stile made of MDF covered with PREMIUM veneer.
- 16 mm thick HDF boards covered with Premium veneer (vertical graining).

## HARDWARE

- 3 silver 2-pin hinges adjustable in the horizontal plane in the rebated door sash.
- 3 hinges hidden in the non-rebated door sash in silver (optionally in black for an extra charge); hinges are delivered and priced with the door frame.
- A lever tumbler lock in the rebated door sash and a magnetic lock in the non-rebated door sash, key-operated, cylinder lock, economy lock or silver-coloured blockade; optional black magnetic lock for an extra charge.

## GLAZING

- 4 mm frosted decormat glass or VSG 221 laminated glass at an extra charge, frosted glass or black safety glass, smooth on both sides.
- Possibility of changing the glazing side to REVERSE (OBVERSE standard glazing).

VSG 221 laminated glass, frosted glass or black safety glass, smooth on both sides.

Metal covers for hinges in the rebated door sash (colour: brushed nickel, patina, glossy chrome, glossy brass, white and black).

Replaced with a black magnetic lock for non-rebated door sashes.

# EPIMEDIUM

REBATED AND NON-REBATED INTERIOR STILE DOORS



EPIMEDIUM 4, ASH GRAPHITE PREMIUM decor, CUBE door handle brushed matt chrome

## SOLUTIONS AVAILABLE

**PL**

PL Standard

**CZ**

CZ Standard

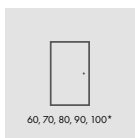

single-sash door

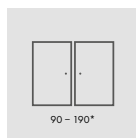

double doors

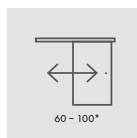

single-sash sliding door

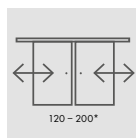

double-sash sliding door

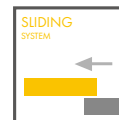
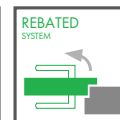
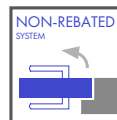

## AVAILABLE DOOR SASH WIDTHS

60

70

80

90

100

## MDF STILE

for GREKO, PREMIUM and CPL veneers





## CONSTRUCTION

- Rebated or non-rebated door sash made in STILE technology.
- Vertical and horizontal MDF stile covered with GREKO, PREMIUM, ST CPL or ST CPL veneers with AntiFinger coating. **NEW**
- HDF boards, 4 mm thick, covered with GREKO, CPL or Premium veneer.
- Narrow longitudinal crossbar th. 22mm.

## HARDWARE

- 3 silver 2-pin hinges adjustable in the horizontal plane in the rebated door sash.
- 3 hinges hidden in the non-rebated door sash in silver (optionally in black for an extra charge); hinges are delivered and priced with the door frame.
- A lever tumbler lock in the rebated door sash and a magnetic lock in the non-rebated door sash, key-operated, cylinder lock, economy lock or silver-coloured blockade; optional black magnetic lock for an extra charge.

## GLAZING

- Standard frosted or transparent 4 mm tempered glass and VSG 221 laminated glass, safety glass, smooth on both sides, available at an extra charge.
- Possibility of changing the glazing side to REVERSE (OBVERSE standard glazing).
- Variable width of the glass, depending on the width of the sash. See [www.erkado.pl](http://www.erkado.pl).

\* ) The presented photos of EPIMEDIUM doors refer only to the "80" sash width. In the other widths, there are significant differences in the proportions of the glass in relation to the vertical crossbars, which may be noticed by the customer when choosing a product. Graphics showing individual widths can be found at [www.erkado.pl](http://www.erkado.pl)

### GREKO

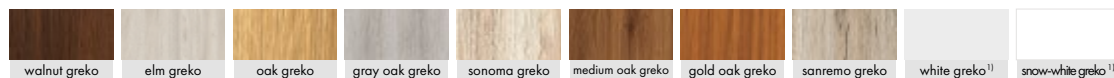

### PREMIUM



### CPL



### EXTRA CHARGE

Ventilation undercut or recuperation shortcut.

Wood-like plastic sleeves (4 pcs.).

Round and square metal sleeves (4 pcs.) brushed nickel, patina, white and black finish.

Ventilation grille (only for door sash widths: 80, 90, 100).

Rebated and non-rebated "100" door sash.

VSG 221 laminated glass, frosted glass or black safety glass, smooth on both sides.

Metal covers for hinges in the rebated door sash (colour: brushed nickel, patina, glossy chrome, glossy brass, white and black).

Replaced with a black magnetic lock for non-rebated door sashes.

Drop down gasket.

<sup>1)</sup> Smooth white veneer imitating painted surface.

<sup>2)</sup> Special AntiFinger **NEW** coating to reduce dirt and fingerprints.

# MAGNOLIA

REBATED AND NON-REBATED INTERIOR STILE DOORS



MAGNOLIA 1, GREKO WALNUT decor, DECO door handle

## SOLUTIONS AVAILABLE

**PL**

PL Standard

**CZ**

CZ Standard

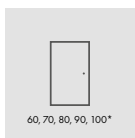

single-sash door

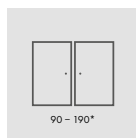

double doors

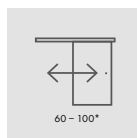

single-sash  
sliding door

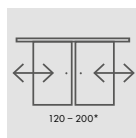

double-sash  
sliding door

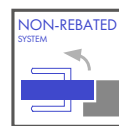

NON-REBATED  
SYSTEM

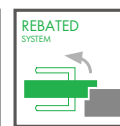

REBATED  
SYSTEM

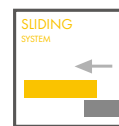

SLIDING  
SYSTEM

AVAILABLE **DOOR SASH WIDTHS**

60

70

80

90

100

### MDF STILE

for GREKO, PREMIUM and CPL veneers



## CONSTRUCTION

- Rebated or non-rebated door sash made in STILE technology.
- Vertical and horizontal MDF stile covered with GREKO, PREMIUM, ST CPL or ST CPL veneers with AntiFinger coating. **NEW**
- HDF boards, 4 mm thick, covered with GREKO, CPL or Premium veneer.

## HARDWARE

- 3 silver 2-pin hinges adjustable in the horizontal plane in the rebated door sash.
- 3 hinges hidden in the non-rebated door sash in silver (optionally in black for an extra charge); hinges are delivered and priced with the door frame.
- A lever tumbler lock in the rebated door sash and a magnetic lock in the non-rebated door sash, key-operated, cylinder lock, economy lock or silver-coloured blockade; optional black magnetic lock for an extra charge.

## GLAZING

- Standard frosted or transparent 4 mm tempered glass and VSG 221 laminated glass, safety glass, smooth on both sides, available at an extra charge.
- Possibility of changing the glazing side to REVERSE (OBVERSE standard glazing).



### GREKO

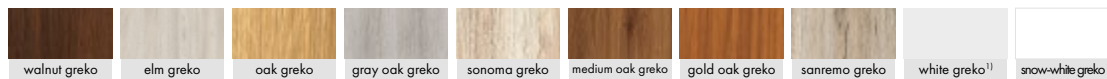

### PREMIUM



### CPL



### EXTRA CHARGE

- Ventilation undercut or recuperation shortcut.
- Wood-like plastic sleeves (4 pcs.).
- Round and square metal sleeves (4 pcs.) brushed nickel, patina, white and black finish.
- Ventilation grille (only for door sash widths: 80, 90, 100).
- Rebated and non-rebated "100" door sash.
- Drop down gasket.

- VSG 221 laminated glass, frosted glass or black safety glass, smooth on both sides.
- Metal covers for hinges in the rebated door sash (colour: brushed nickel, patina, glossy chrome, glossy brass, white and black).
- Replaced with a black magnetic lock for non-rebated door sashes.

<sup>1)</sup> Smooth white veneer imitating painted surface. <sup>2)</sup> Special **AntiFinger** **NEW** coating to reduce dirt and fingerprints.

# IRYS

REBATED AND NON-REBATED INTERIOR STILE DOORS

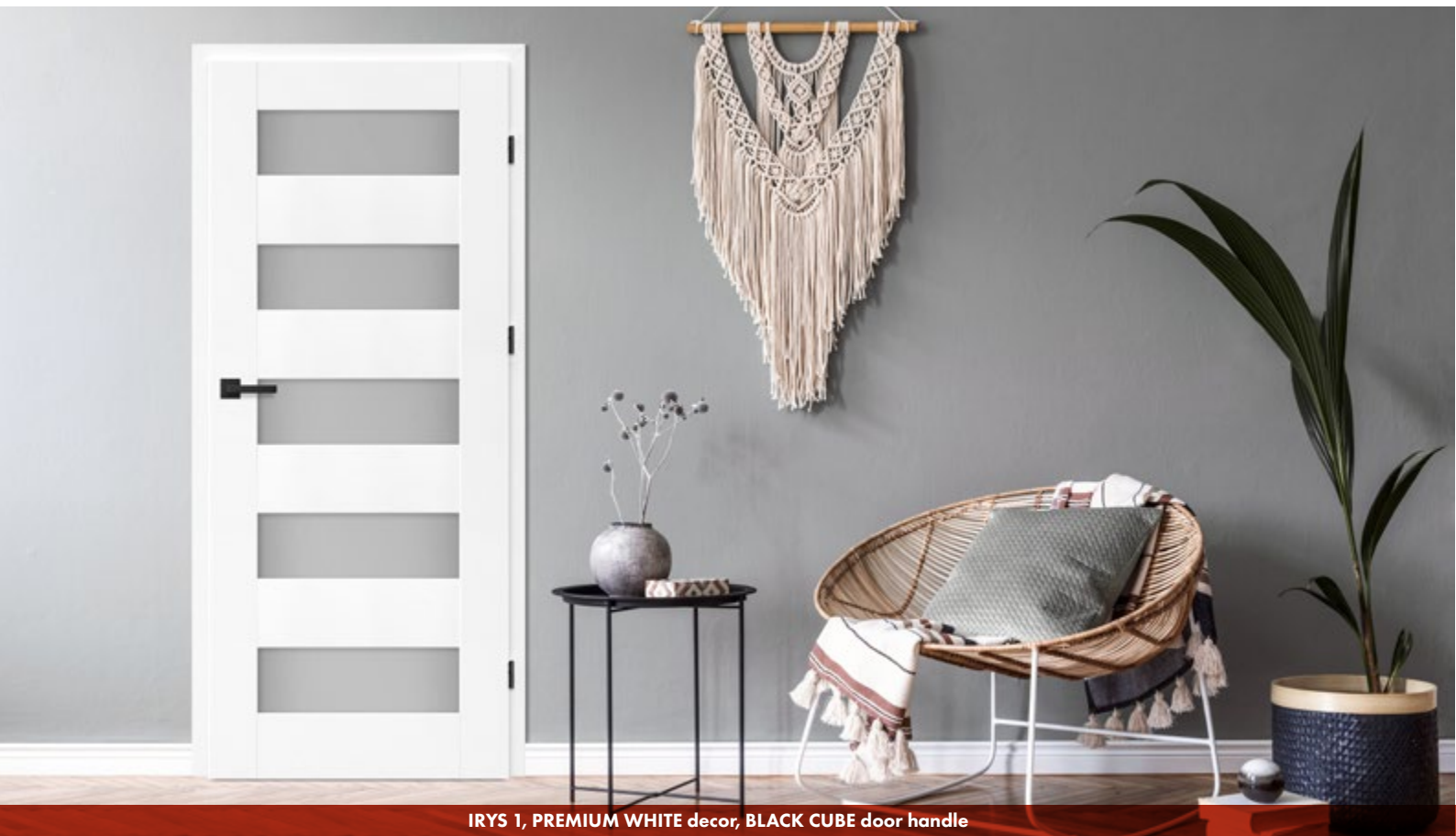

IRYS 1, PREMIUM WHITE decor, BLACK CUBE door handle

## SOLUTIONS AVAILABLE

**PL**

PL Standard

**CZ**

CZ Standard

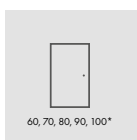

single-sash door

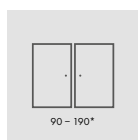

double doors

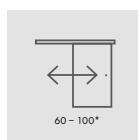

single-sash sliding door

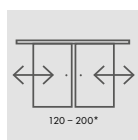

double-sash sliding door

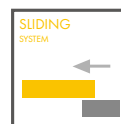
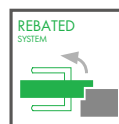
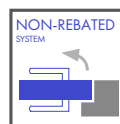

AVAILABLE **DOOR SASH WIDTHS**

60

70

80

90

100

### MDF STILE

for GREKO, PREMIUM and CPL veneers



## CONSTRUCTION

- Rebated or non-rebated door sash made in STILE technology.
- Vertical and horizontal MDF stile covered with GREKO, PREMIUM, ST CPL or ST CPL veneers with AntiFinger coating. **NEW**
- HDF boards, 4 mm thick, covered with GREKO, CPL or Premium veneer.

## HARDWARE

- 3 silver 2-pin hinges adjustable in the horizontal plane in the rebated door sash.
- 3 hinges hidden in the non-rebated door sash in silver (optionally in black for an extra charge); hinges are delivered and priced with the door frame.
- A lever tumbler lock in the rebated door sash and a magnetic lock in the non-rebated door sash, key-operated, cylinder lock, economy lock or silver-coloured blockade; optional black magnetic lock for an extra charge.

## GLAZING

- Standard frosted or transparent 4 mm tempered glass and VSG 221 laminated glass, safety glass, smooth on both sides, available at an extra charge.
- Possibility of changing the glazing side to REVERSE (OBSERVE standard glazing).



### GREKO



### PREMIUM



### CPL



### EXTRA CHARGE

Ventilation undercut or recuperation shortcut.

Wood-like plastic sleeves (4 pcs.).

Round and square metal sleeves (4 pcs.) brushed nickel, patina, white and black finish.

Ventilation grille (only for door sash widths: 80, 90, 100).

Rebated and non-rebated "100" door sash.

Drop down gasket<sup>2)</sup>.

VSG 221 laminated glass, frosted glass or black safety glass, smooth on both sides.

Metal covers for hinges in the rebated door sash (colour: brushed nickel, patina, glossy chrome, glossy brass, white and black).

Replaced with a black magnetic lock for non-rebated door sashes.

<sup>1)</sup> Smooth white veneer imitating painted surface.

<sup>2)</sup> Special **AntiFinger** **NEW** coating to reduce dirt and fingerprints.

# DAGLEZJA

REBATED AND NON-REBATED INTERIOR STILE DOORS



DAGLEZJA 1, GREKO GRAY OAK decor, CUBE SLIM door handle square black matt

## SOLUTIONS AVAILABLE

**PL**

PL Standard

**CZ**

CZ Standard

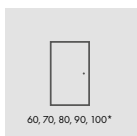

single-sash door

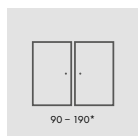

double doors

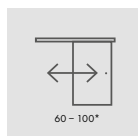

single-sash sliding door

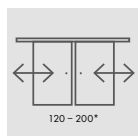

double-sash sliding door

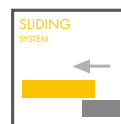
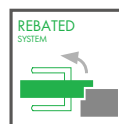
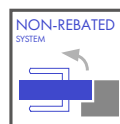

### AVAILABLE DOOR SASH WIDTHS

60

70

80

90

100

### MDF STILE

for GREKO, PREMIUM and CPL veneers





## CONSTRUCTION

- Rebated or non-rebated door sash made in STILE technology.
- Vertical and horizontal MDF stile covered with GREKO, PREMIUM, ST CPL or ST CPL veneers with AntiFinger coating. **NEW**
- HDF boards, 4 mm thick, covered with GREKO, CPL or Premium veneer.
- A very wide bar.

## HARDWARE

- 3 silver 2-pin hinges adjustable in the horizontal plane in the rebated door sash.
- 3 hinges hidden in the non-rebated door sash in silver (optionally in black for an extra charge); hinges are delivered and priced with the door frame.
- A lever tumbler lock in the rebated door sash and a magnetic lock in the non-rebated door sash, key-operated, cylinder lock, economy lock or silver-coloured blockade; optional black magnetic lock for an extra charge.

## GLAZING

- Standard frosted or transparent 4 mm tempered glass and VSG 221 laminated glass, safety glass, smooth on both sides, available at an extra charge.
- Possibility of changing the glazing side to REVERSE (OBVERSE standard glazing).

### GREKO



### PREMIUM



### CPL



### EXTRA CHARGE

Ventilation undercut or recuperation shortcut.

Wood-like plastic sleeves (4 pcs.).

Round and square metal sleeves (4 pcs.) brushed nickel, patina, white and black finish.

Ventilation grille (only for door sash widths: 80, 90, 100).

Rebated and non-rebated "100" door sash.

Drop down gasket<sup>2)</sup>.

VSG 221 laminated glass, frosted glass or black safety glass, smooth on both sides.

Metal covers for hinges in the rebated door sash (colour: brushed nickel, patina, glossy chrome, glossy brass, white and black).

Replaced with a black magnetic lock for non-rebated door sashes.

<sup>1)</sup> Smooth white veneer imitating painted surface.

<sup>2)</sup> Special **AntiFinger** **NEW** coating to reduce dirt and fingerprints.

# FREZJA

REBATED AND NON-REBATED INTERIOR STILE DOORS



FREZJA 5, GRAY PINE ST CPL decor, CUBE SLIM black matt door handle

## SOLUTIONS AVAILABLE

**PL**

PL Standard

**CZ**

CZ Standard

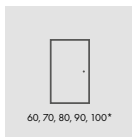

60, 70, 80, 90, 100\*

single-sash door

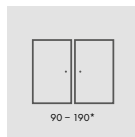

90 - 190\*

double doors

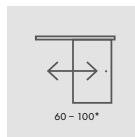

60 - 100\*

single-sash sliding door <sup>3)</sup>

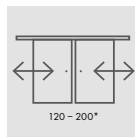

120 - 200\*

double-sash sliding door <sup>3)</sup>

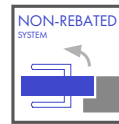

NON-REBATED SYSTEM

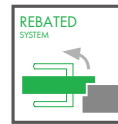

REBATED SYSTEM

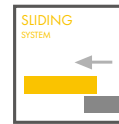

SLIDING SYSTEM

AVAILABLE **DOOR SASH WIDTHS**

60

70

80

90

100

VENTILATION **UNDERCUT**

FREZJA 8



**MDF STILE** **NEW**

for GREKO, PREMIUM and CPL veneers



FREZJA 2



FREZJA 4



FREZJA 6

## CONSTRUCTION

- Rebated or non-rebated door sash made in STILE technology.
- Vertical and horizontal MDF stile covered with GREKO, PREMIUM, ST CPL or ST CPL veneers with AntiFinger coating. **NEW**
- Panels made of 16 mm thick HDF board (FREZJA 2 and 6 models also have a 4 mm panel) covered with GREKO, CPL or PREMIUM veneer, FREZJA 7 available only with a mirror.

## HARDWARE

- 3 silver 2-pin hinges adjustable in the horizontal plane in the rebated door sash.
- 3 hinges hidden in the non-rebated door sash in silver (optionally in black for an extra charge); hinges are delivered and priced with the door frame.
- A lever tumbler lock in the rebated door sash and a magnetic lock in the non-rebated door sash, key-operated, cylinder lock, economy lock or silver-coloured blockade; optional black magnetic lock for an extra charge.

## GLAZING

- Standard frosted glass, transparent 4 mm or mirror on one side (Frezja 7 only) and VSG 221 laminated glass, frosted glass or black safety glass, smooth on both sides (except Frezja 7,8).
- Possibility of changing the glazing side to REVERSE (OBVERSE standard glazing).
- Fixed glazing width; Frezja 1-140 mm, Frezja 5-70 mm.



### GREKO



### PREMIUM



### CPL



### EXTRA CHARGE

Ventilation undercut or recuperation shortcut.

Wood-like plastic sleeves (4 pcs.)<sup>2)</sup>

Round and square metal sleeves (4 pcs.)<sup>2)</sup> brushed nickel, patina, white and black finish.

Ventilation grille<sup>2)</sup> (only for door sash widths: 80, 90, 100)

Rebated and non-rebated "100" door sash.

VSG 221 laminated glass, frosted or black safety glass, smooth on both sides – models FREZJA 1, 2, 3.

Replaced with a black magnetic lock for non-rebated door sashes.

Drop down gasket (FREZJA 8 not available)

Metal covers for hinges in the rebated door sash (colour: brushed nickel, patina, glossy chrome, glossy brass, white and black).

<sup>1)</sup> Smooth white veneer imitating painted surface. <sup>2)</sup> Not available in FREZJA 8. <sup>3)</sup> FREZJA 8 is not available in sliding systems.

<sup>4)</sup> Special **AntiFinger** **NEW** coating to reduce dirt and fingerprints.

# NEMEZJA

REBATED AND NON-REBATED INTERIOR STILE DOORS



NEMEZJA 12, WHITE PREMIUM decor, CUBE PREMIUM black matt door handle

## SOLUTIONS AVAILABLE

**PL**

PL Standard

**CZ**

CZ Standard

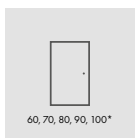

60, 70, 80, 90, 100\*

single-sash door

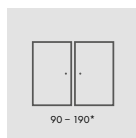

90 - 190\*

double doors

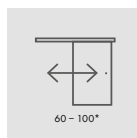

60 - 100\*

single-sash  
sliding door

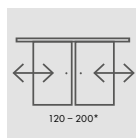

120 - 200\*

double-sash  
sliding door

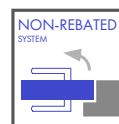

NON-REBATED  
SYSTEM

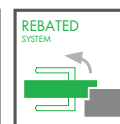

REBATED  
SYSTEM

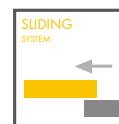

SLIDING  
SYSTEM

### AVAILABLE DOOR SASH WIDTHS

60

70

80

90

100

### MDF STILE

for GREKO, PREMIUM and CPL veneers





## CONSTRUCTION

- Rebated or non-rebated door sash made in STILE technology.
- Vertical and horizontal MDF rails covered with GREKO veneer and CPL with AntiFinger coating covered with PREMIUM veneer or CPL without AntiFinger coating.
- Panels made of 16 mm thick HDF board, chamfered and covered with veneer in selected GREKO, CPL or PREMIUM decors.

NEW



## HARDWARE

- 3 silver 2-pin hinges adjustable in the horizontal plane in the rebated door sash.
- 3 hinges hidden in the non-rebated door sash in silver (optionally in black for an extra charge); hinges are delivered and priced with the door frame.
- A lever tumbler lock in the rebated door sash and a magnetic lock in the non-rebated door sash, key-operated, cylinder lock, economy lock or silver-coloured blockade; optional black magnetic lock for an extra charge.



## GLAZING

- Standard frosted or transparent 4 mm tempered glass and VSG 221 laminated glass, safety glass, smooth on both sides, available at an extra charge.
- Possibility of changing the glazing side to REVERSE (OBVERSE standard glazing).

### GREKO



### PREMIUM



### CPL



### EXTRA CHARGE

Ventilation undercut or recuperation shortcut.

Wood-like plastic sleeves (4 pcs.).

Round and square metal sleeves (4 pcs.) brushed nickel, patina, white and black finish.

Ventilation grille (only for door sash widths: 80, 90, 100).

Rebated and non-rebated "100" door sash.

Drop down gasket.

VSG 221 frosted glass, smooth on both sides

NEMEZIA 1  
NEMEZIA 9, 13  
NEMEZIA 7  
NEMEZIA 4, 11  
NEMEZIA 10

Metal covers for hinges in the rebated door sash (colour: brushed nickel, patina, glossy chrome, glossy brass, white and black).

Replaced with a black magnetic lock for non-rebated door sashes.

<sup>1)</sup> Smooth white veneer imitating painted surface.

<sup>2)</sup> Special AntiFinger **NEW** coating to reduce dirt and fingerprints.

# BERBERYS

REBATED AND NON-REBATED INTERIOR STILE DOORS



BERBERYS 1, ASH GRAPHITE PREMIUM decor, TOPAZ INOX door handle

## SOLUTIONS AVAILABLE

PL

PL Standard

CZ

CZ Standard

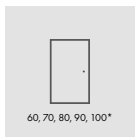

60, 70, 80, 90, 100\*

single-sash door

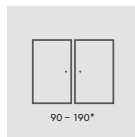

90 - 190\*

double doors

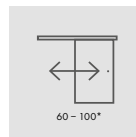

60 - 100\*

single-sash sliding door

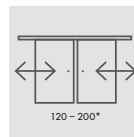

120 - 200\*

double-sash sliding door

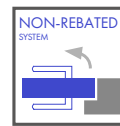

NON-REBATED SYSTEM

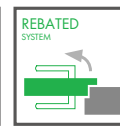

REBATED SYSTEM

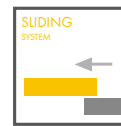

SLIDING SYSTEM

AVAILABLE **DOOR SASH WIDTHS**

60

70

80

90

100

### MDF STILE

for GREKO, PREMIUM and CPL veneers



## CONSTRUCTION

- Rebated or non-rebated door sash made in STILE technology.
- Vertical and horizontal MDF stile covered with GREKO, PREMIUM, ST CPL or ST CPL veneers with AntiFinger coating. **NEW**
- HDF boards, 4 mm thick, covered with GREKO, CPL or Premium veneer.
- Brushed aluminium inserts.

## HARDWARE

- 3 silver 2-pin hinges adjustable in the horizontal plane in the rebated door sash.
- 3 hinges hidden in the non-rebated door sash in silver (optionally in black for an extra charge); hinges are delivered and priced with the door frame.
- A lever tumbler lock in the rebated door sash and a magnetic lock in the non-rebated door sash, key-operated, cylinder lock, economy lock or silver-coloured blockade; optional black magnetic lock for an extra charge.

## GLAZING

- Standard frosted or transparent 4 mm tempered glass and VSG 221 laminated glass, safety glass, smooth on both sides, available at an extra charge.
- Possibility of changing the glazing side to REVERSE (OBVERSE standard glazing).



### GREKO

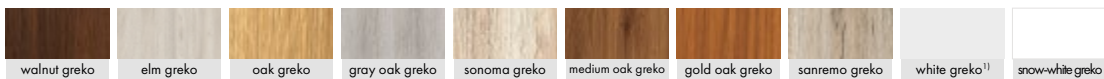

### PREMIUM



### CPL



### EXTRA CHARGE

Ventilation undercut or recuperation shortcut.

Wood-like plastic sleeves (4 pcs.).

Round and square metal sleeves (4 pcs.) brushed nickel, patina, white and black finish.

Ventilation grille (only for door sash widths: 80, 90, 100).

Rebated and non-rebated "100" door sash.

Drop down gasket.

VSG 221 laminated glass, frosted glass or black safety glass, smooth on both sides.

Metal covers for hinges in the rebated door sash (colour: brushed nickel, patina, glossy chrome, glossy brass, white and black)

Replaced with a black magnetic lock for non-rebated door sashes.

<sup>1)</sup> Smooth white veneer imitating painted surface.

<sup>2)</sup> Special **AntiFinger** **NEW** coating to reduce dirt and fingerprints.

# FLOKS

REBATED AND NON-REBATED INTERIOR STILE DOORS



FLOKS 8, OAK ST CPL decor, CUBE door handle brushed matt chrome

## SOLUTIONS AVAILABLE

**PL**

PL Standard

**CZ**

CZ Standard

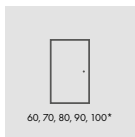

single-sash door

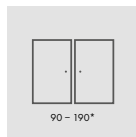

double doors

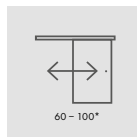

single-sash  
sliding door

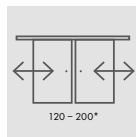

double-sash  
sliding door

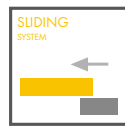
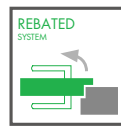
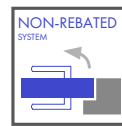

AVAILABLE **DOOR SASH WIDTHS**

60

70

80

90

100

### MDF STILE

for GREKO, PREMIUM and CPL veneers



## CONSTRUCTION

- Rebated or non-rebated door sash made in STILE technology.
- Vertical and horizontal MDF stile covered with GREKO, PREMIUM, ST CPL or ST CPL veneers with AntiFinger coating. **NEW**
- HDF boards, 4 mm thick, covered with GREKO, CPL or Premium veneer.
- Brushed aluminium inserts.

## HARDWARE

- 3 silver 2-pin hinges adjustable in the horizontal plane in the rebated door sash.
- 3 hinges hidden in the non-rebated door sash in silver (optionally in black for an extra charge); hinges are delivered and priced with the door frame.
- A lever tumbler lock in the rebated door sash and a magnetic lock in the non-rebated door sash, key-operated, cylinder lock or silver-coloured blockade; optional black magnetic lock for an extra charge.

## GLAZING

- Standard frosted or transparent 4 mm tempered glass and VSG 221 laminated glass, safety glass, smooth on both sides, available at an extra charge.
- Possibility of changing the glazing side to REVERSE (OBVERSE standard glazing).



### GREKO



### PREMIUM



### CPL



### EXTRA CHARGE

Ventilation undercut or recuperation shortcut.

Wood-like plastic sleeves (4 pcs.).

Round and square metal sleeves (4 pcs.) brushed nickel, patina, white and black finish.

Ventilation grille (only for door sash widths: 80, 90, 100).

Rebated and non-rebated "100" door sash.

Drop down gasket.

VSG 221 laminated glass, frosted glass or black safety glass, smooth on both sides.

Metal covers for hinges in the rebated door sash (colour: brushed nickel, patina, glossy chrome, glossy brass, white and black).

Replaced with a black magnetic lock for non-rebated door sashes.

<sup>1)</sup> Smooth white veneer imitating painted surface. <sup>2)</sup> Special **AntiFinger** **NEW** coating to reduce dirt and fingerprints.

# KAMELIA

REBATED AND NON-REBATED INTERIOR STILE DOORS



KAMELIA 1, ASH GRAPHITE PREMIUM decor, CUBE door handle brushed matt chrome

## SOLUTIONS AVAILABLE

**PL**

PL Standard

**CZ**

CZ Standard

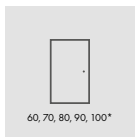

single-sash door

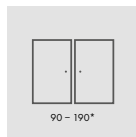

double doors

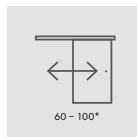

single-sash sliding door

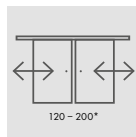

double-sash sliding door

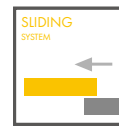
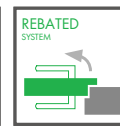
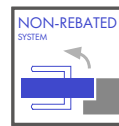

### AVAILABLE DOOR SASH WIDTHS

60

70

80

90

100

### MDF STILE

for GREKO, PREMIUM and CPL veneers





## CONSTRUCTION

- Rebated or non-rebated door sash made in STILE technology.
- Vertical and horizontal MDF stile covered with GREKO, PREMIUM, ST CPL or ST CPL veneers with AntiFinger coating. NEW
- HDF boards, 4 mm thick, covered with GREKO, CPL or Premium veneer.

## HARDWARE

- 3 silver 2-pin hinges adjustable in the horizontal plane in the rebated door sash.
- 3 hinges hidden in the non-rebated door sash in silver (optionally in black for an extra charge); hinges are delivered and priced with the door frame.
- A lever tumbler lock in the rebated door sash and a magnetic lock in the non-rebated door sash, key-operated, cylinder lock, economy lock or silver-coloured blockade; optional black magnetic lock for an extra charge.

## GLAZING

- Standard frosted or transparent 4 mm tempered glass and VSG 221 laminated glass, safety glass, smooth on both sides, available at an extra charge.
- Possibility of changing the glazing side to REVERSE (OBVERSE standard glazing).

### GREKO

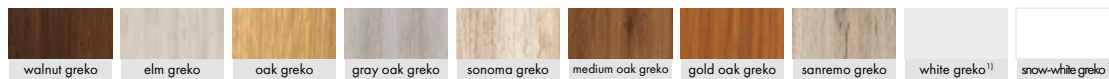

### PREMIUM



### CPL



### EXTRA CHARGE

- Ventilation undercut or recuperation shortcut.
- Wood-like plastic sleeves (4 pcs.).
- Round and square metal sleeves (4 pcs.) brushed nickel, patina, white and black finish.
- Ventilation grille (only for door sash widths: 80, 90, 100).
- Rebated and non-rebated "100" door sash.
- Drop down gasket.

- VSG 221 laminated glass, frosted glass or black safety glass, smooth on both sides.
- Metal covers for hinges in the rebated door sash (colour: brushed nickel, patina, glossy chrome, glossy brass, white and black)
- Replaced with a black magnetic lock for non-rebated door sashes.

<sup>1)</sup> Smooth white veneer imitating painted surface.  
<sup>2)</sup> Special **AntiFinger** NEW coating to reduce dirt and fingerprints.

# FRAGI

INTERNAL DOOR SASHES FRAME STILE REBATED



FRAGI 16, WHITE ST CPL decor, CUBE black matt door handle, black VSG glass

## SOLUTIONS AVAILABLE

**PL**

PL Standard

**CZ**

CZ Standard

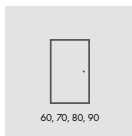

single-sash door

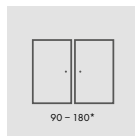

double doors

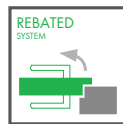

AVAILABLE **DOOR SASH WIDTHS**

60

70

80

90

STANDARD **GLAZING "OBVERSE"**



CUSTOM **GLAZING "REVERSE"**



**MDF STILE**

for GREKO, PREMIUM and CPL veneers



## CONSTRUCTION

- Rebated door sash made in STILE technology.
- Vertical and horizontal MDF stile covered with GREKO, PREMIUM, ST CPL or ST CPL veneers with AntiFinger coating. **NEW**

## HARDWARE

- 3 silver 2-pin hinges adjustable in the horizontal plane in the rebated door sash.
- Keyed lever tumbler lock, cylinder lock, economy lock or lockable.

## GLAZING

- 8 mm tempered glass or VSG/ESG 441 tempered and laminated glass, frosted glass or black safety glass, smooth on both sides (Fragi 15 and Fragi 16 models).
- Possibility of changing the glazing side to REVERSE (OBVERSE standard glazing).

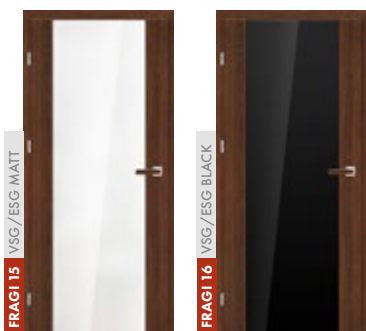

### GREKO

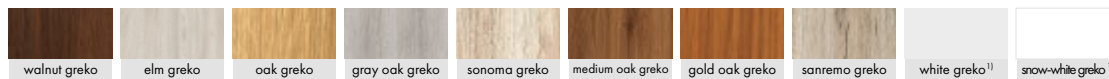

### PREMIUM



### CPL



### EXTRA CHARGE

Ventilation undercut.

Metal covers for hinges in the rebated door sash (colour: brushed nickel, patina, glossy chrome, glossy brass, white and black).

<sup>1)</sup> Smooth white veneer imitating painted surface. <sup>2)</sup> Special AntiFinger **NEW** coating to reduce dirt and fingerprints.

ATTENTION: The presented door graphics are for the 80 sash width only. In the other widths in the FRAGI 1 model there are slight differences in graphic proportions. Detailed information and photos can be found on our website [www.erkado.pl](http://www.erkado.pl)

# SURMIA

REBATED AND NON-REBATED INTERIOR STILE DOORS



SURMIA 1, WENGE ST CPL decor, CUBE door handle brushed matt chrome

## SOLUTIONS AVAILABLE

**PL**

PL Standard

**CZ**

CZ Standard

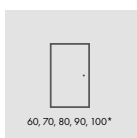

single-sash door

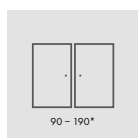

double doors

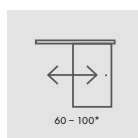

single-sash  
sliding door

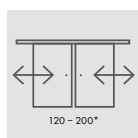

double-sash  
sliding door

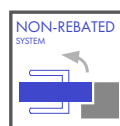

NON-REBATED  
SYSTEM

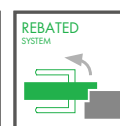

REBATED  
SYSTEM

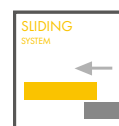

SLIDING  
SYSTEM

AVAILABLE **DOOR SASH WIDTHS**

60

70

80

90

100

### MDF STILE

for GREKO, PREMIUM and CPL veneers





Grain directions

## CONSTRUCTION

- Rebated or non-rebated door sash made in STILE technology.
- Vertical and horizontal MDF stiles covered with PREMIUM, ST CPL or ST CPL veneer with AntiFinger coating. **NEW**
- Extra wide 35 mm thick bar.
- HDF boards, 22 mm and 4 mm thick, covered with CPL or PREMIUM veneer.

## HARDWARE

- 3 silver 2-pin hinges adjustable in the horizontal plane in the rebated door sash.
- 3 hinges hidden in the non-rebated door sash in silver (optionally in black for an extra charge); hinges are delivered and priced with the door frame.
- A lever tumbler lock in the rebated door sash and a magnetic lock in the non-rebated door sash, key-operated, cylinder lock, economy lock or silver-coloured blockade; optional black magnetic lock for an extra charge.

## GLAZING

- Standard frosted or transparent 4 mm tempered glass and VSG 221 laminated glass, safety glass, smooth on both sides, available at an extra charge.
- Possibility of changing the glazing side to REVERSE (OBVERSE standard glazing).

### PREMIUM



### CPL



### EXTRA CHARGE

Ventilation undercut or recuperation shortcut.

Wood-like plastic sleeves (4 pcs.).

Round and square metal sleeves (4 pcs.) brushed nickel, patina, white and black finish.

Ventilation grille (only for door sash widths: 80, 90, 100).

Rebated and non-rebated "100" door sash.

Drop down gasket.

VSG 221 laminated glass, frosted glass or black safety glass, smooth on both sides.

Metal covers for hinges in the rebated door sash (colour: brushed nickel, patina, glossy chrome, glossy brass, white and black)

Replaced with a black magnetic lock for non-rebated door sashes.

<sup>1)</sup> Smooth white veneer imitating painted surface.

<sup>2)</sup> Special **AntiFinger** **NEW** coating to reduce dirt and fingerprints.

# POWOJNIK

REBATED AND NON-REBATED INTERIOR STILE DOORS



POWOJNIK 1, GRAY OAK ST CPL decor, TOPAZ INOX door handle

## SOLUTIONS AVAILABLE

PL

PL Standard

CZ

CZ Standard

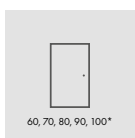

single-sash door

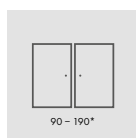

double doors

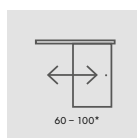

single-sash  
sliding door

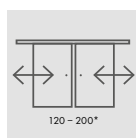

double-sash  
sliding door

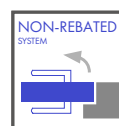

NON-REBATED SYSTEM

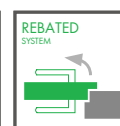

REBATED SYSTEM

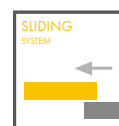

SLIDING SYSTEM

AVAILABLE **DOOR SASH WIDTHS**

60

70

80

90

100

### MDF STILE

for GREKO, PREMIUM and CPL veneers





## CONSTRUCTION

- Rebated or non-rebated door sash made in STILE technology.
- Vertical and horizontal MDF stiles covered with PREMIUM, ST CPL or ST CPL veneer with AntiFinger coating. **NEW**
- Panels made of HDF board, 4 mm thick, covered with CPL or PREMIUM veneer.
- Central crossbars 22 mm and a very wide upper and lower bar th.35mm.

## HARDWARE

- 3 silver 2-pin hinges adjustable in the horizontal plane in the rebated door sash.
- 3 hinges hidden in the non-rebated door sash in silver (optionally in black for an extra charge); hinges are delivered and priced with the door frame.
- A lever tumbler lock in the rebated door sash and a magnetic lock in the non-rebated door sash, key-operated, cylinder lock, economy lock or silver-coloured blockade; optional black magnetic lock for an extra charge.

## GLAZING

- Standard frosted or transparent 4 mm tempered glass and VSG 221 laminated glass, safety glass, smooth on both sides, available at an extra charge.
- Possibility of changing the glazing side to REVERSE (OBSERVE standard glazing).

### PREMIUM



### CPL



### EXTRA CHARGE

Ventilation undercut or recuperation shortcut.

Wood-like plastic sleeves (4 pcs.).

Round and square metal sleeves (4 pcs.) brushed nickel, patina, white and black finish.

Ventilation grille (only for door sash widths: 80, 90, 100).

Rebated and non-rebated "100" door sash.

Drop down gasket.

VSG 221 laminated glass, frosted glass or black safety glass, smooth on both sides.

Metal covers for hinges in the rebated door sash (colour: brushed nickel, patina, glossy chrome, glossy brass, white and black)

Replaced with a black magnetic lock for non-rebated door sashes.

<sup>1)</sup> Smooth white veneer imitating painted surface.

<sup>2)</sup> Special **AntiFinger** **NEW** coating to reduce dirt and fingerprints.

# PETUNIA

REBATED AND NON-REBATED INTERIOR STILE DOORS



PETUNIA 1, PREMIUM OAK decor, TOPAZ INOX door handle

## SOLUTIONS AVAILABLE

**PL**

PL Standard

**CZ**

CZ Standard

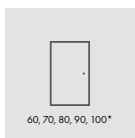

single-sash door

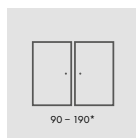

double doors

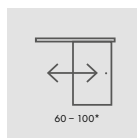

single-sash  
sliding door

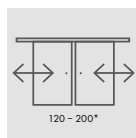

double-sash  
sliding door

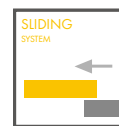
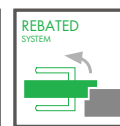
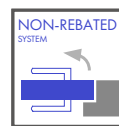

### AVAILABLE DOOR SASH WIDTHS

60

70

80

90

100

### MDF STILE

for GREKO, PREMIUM and CPL veneers



## CONSTRUCTION

- Rebated or non-rebated door sash made in STILE technology.
- Vertical and horizontal MDF stile covered with GREKO, PREMIUM, ST CPL or ST CPL veneers with AntiFinger coating. NEW
- HDF boards, 4 mm thick, covered with GREKO, CPL or Premium veneer.

## HARDWARE

- 3 silver 2-pin hinges adjustable in the horizontal plane in the rebated door sash.
- 3 hinges hidden in the non-rebated door sash in silver (optionally in black for an extra charge); hinges are delivered and priced with the door frame.
- A lever tumbler lock in the rebated door sash and a magnetic lock in the non-rebated door sash, key-operated, cylinder lock, economy lock or silver-coloured blockade; optional black magnetic lock for an extra charge.

## GLAZING

- Standard frosted or transparent 4 mm tempered glass and VSG 221 laminated glass, safety glass, smooth on both sides, available at an extra charge.
- Possibility of changing the glazing side to REVERSE (OBVERSE standard glazing).



### GREKO



### PREMIUM



### CPL



### EXTRA CHARGE

- Ventilation undercut or recuperation shortcut.
- Wood-like plastic sleeves (4 pcs.).
- Round and square metal sleeves (4 pcs.) brushed nickel, patina, white and black finish.
- Ventilation grille (only for door sash widths: 80, 90, 100).
- Rebated and non-rebated "100" door sash.
- Drop down gasket.

- VSG 221 laminated glass, frosted glass or black safety glass, smooth on both sides.
- Metal covers for hinges in the rebated door sash (colour: brushed nickel, patina, glossy chrome, glossy brass, white and black)
- Replaced with a black magnetic lock for non-rebated door sashes.

<sup>1)</sup> Smooth white veneer imitating painted surface.  
<sup>2)</sup> Special **AntiFinger** NEW coating to reduce dirt and fingerprints.

# ORCHIDEA

REBATED AND NON-REBATED INTERIOR STILE DOORS



ORCHIDEA 5, BLACK ST CPL decor, black matt CUBE door handle, matt VSG 221 glass with an internal black application

## SOLUTIONS AVAILABLE

**PL**

PL Standard

**CZ**

CZ Standard

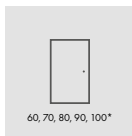

single-sash door

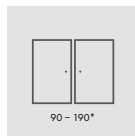

double doors

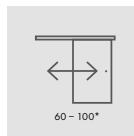

single-sash  
sliding door

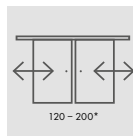

double-sash  
sliding door

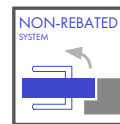

NON-REBATED  
SYSTEM

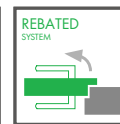

REBATED  
SYSTEM

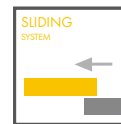

SLIDING  
SYSTEM

### AVAILABLE DOOR SASH WIDTHS

60

70

80

90

100

### MDF STILE

for GREKO, PREMIUM and CPL veneers



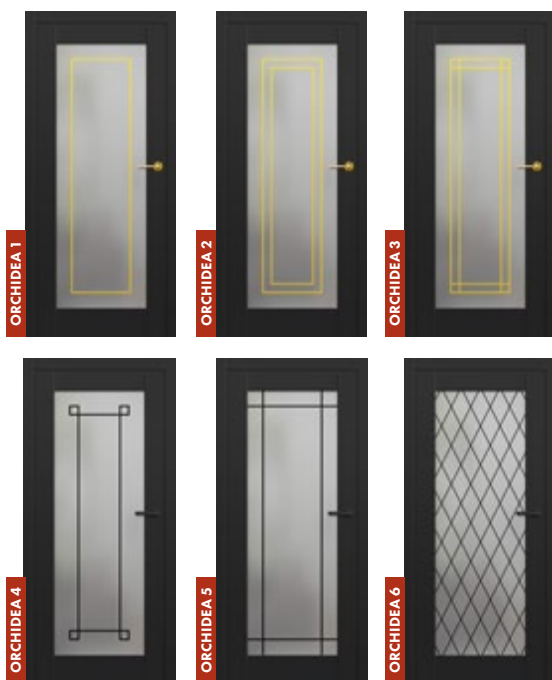

## CONSTRUCTION

- Rebated or non-rebated door sash made in STILE technology.
- Vertical and horizontal MDF stile covered with GREKO, PREMIUM, ST CPL or ST CPL veneers with AntiFinger coating. **NEW**

## HARDWARE

- 3 silver 2-pin hinges adjustable in the horizontal plane in the rebated door sash.
- 3 hinges hidden in the non-rebated door sash in silver (optionally in black for an extra charge); hinges are delivered and priced with the door frame.
- A lever tumbler lock in the rebated door sash and a magnetic lock in the non-rebated door sash, key-operated, cylinder lock, economy lock or silver-coloured blockade; optional black magnetic lock for an extra charge.

## GLAZING

- Standard VSG 221 matt or colourless laminated glass with internal application black or gold. **NEW**

### PREMIUM



### CPL



### EXTRA CHARGE

Ventilation undercut or recuperation shortcut.

Metal covers for hinges in the rebated door sash (colour: brushed nickel, patina, glossy chrome, glossy brass, white and black).

Drop down gasket.

Replaced with a black magnetic lock for non-rebated door sashes.

Rebated and non-rebated "100" door sash.

Wood-like plastic sleeves (4 pcs.).

Ventilation grille (only for door sash widths: 80, 90, 100).

Round and square metal sleeves (4 pcs.); finish: brushed nickel, patina, white and black

<sup>1)</sup> Smooth white veneer imitating painted surface. <sup>2)</sup> Special **AntiFinger** **NEW** coating to reduce dirt and fingerprints.

# LAWENDA

REBATED AND NON-REBATED INTERIOR STILE DOORS

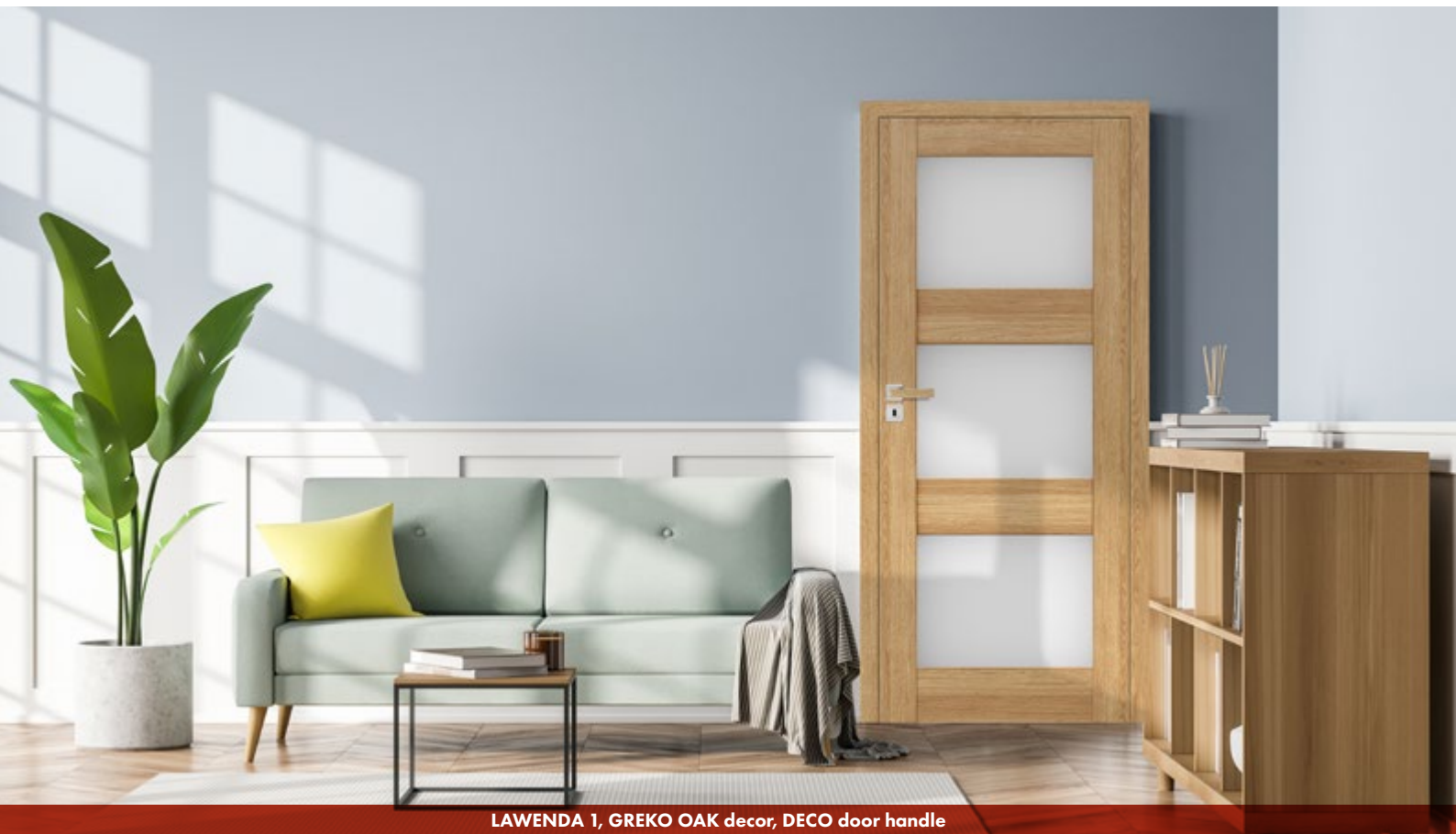

LAWENDA 1, GREKO OAK decor, DECO door handle

## SOLUTIONS AVAILABLE

**PL**

PL Standard

**CZ**

CZ Standard

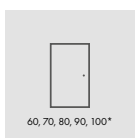

single-sash door

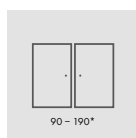

double doors

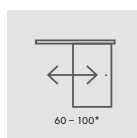

single-sash  
sliding door

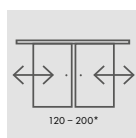

double-sash  
sliding door

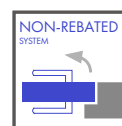

NON-REBATED  
SYSTEM

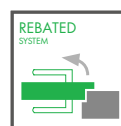

REBATED  
SYSTEM

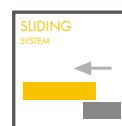

SLIDING  
SYSTEM

### AVAILABLE DOOR SASH WIDTHS

60

70

80

90

100

### MDF STILE

for GREKO, PREMIUM and CPL veneers



## CONSTRUCTION

- Rebated or non-rebated door sash made in STILE technology.
- vertical and horizontal MDF stile covered with GREKO, PREMIUM, ST CPL or ST CPL veneers with AntiFinger coating. NEW
- HDF boards, 4 mm thick, covered with GREKO, CPL or Premium veneer.

## HARDWARE

- 3 silver 2-pin hinges adjustable in the horizontal plane in the rebated door sash.
- 3 hinges hidden in the non-rebated door sash in silver (optionally in black for an extra charge); hinges are delivered and priced with the door frame.
- A lever tumbler lock in the rebated door sash and a magnetic lock in the non-rebated door sash, key-operated, cylinder lock, economy lock or silver-coloured blockade; optional black magnetic lock for an extra charge.

## GLAZING

- Standard frosted or transparent 4 mm tempered glass and VSG 221 laminated glass, safety glass, smooth on both sides, available at an extra charge.
- Possibility of changing the glazing side to REVERSE (OBSERVE standard glazing).

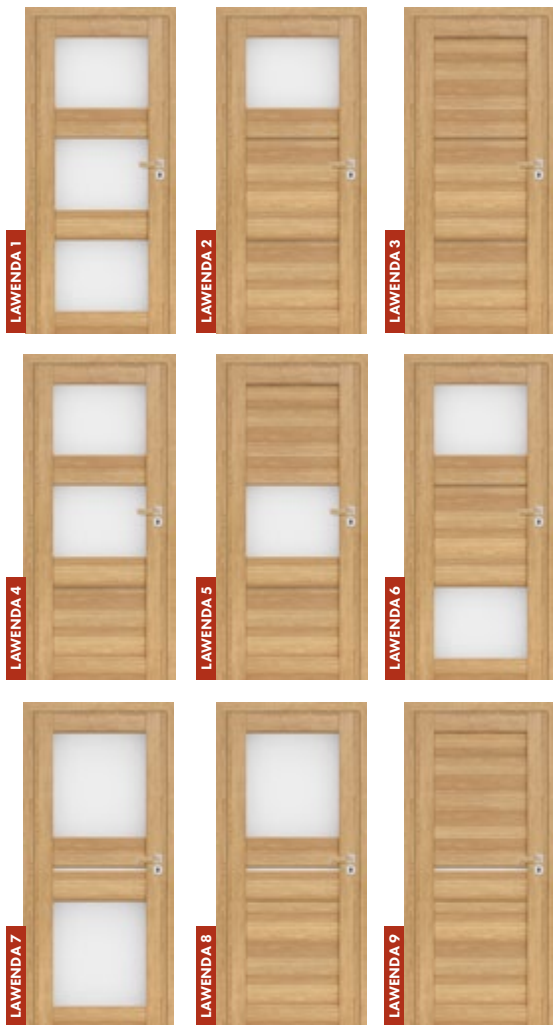

### GREKO

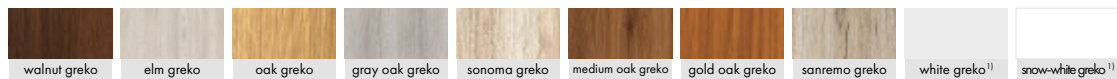

### PREMIUM



### CPL



### EXTRA CHARGE

- Ventilation undercut or recuperation shortcut.
- Wood-like plastic sleeves (4 pcs.).
- Round and square metal sleeves (4 pcs.) brushed nickel, patina, white and black finish.
- Ventilation grille (only for door sash widths: 80, 90, 100).
- Rebated and non-rebated "100" door sash.
- Drop down gasket.

VSG 221 laminated glass, frosted glass or black safety glass, smooth on both sides. models: Lawenda 1,2,4,5,6,7,8,9.

Metal covers for hinges in the rebated door sash (colour: brushed nickel, patina, glossy chrome, glossy brass, white and black)

Replaced with a black magnetic lock for non-rebated door sashes.

<sup>1)</sup> Smooth white veneer imitating painted surface.  
<sup>2)</sup> Special **AntiFinger** NEW coating to reduce dirt and fingerprints.

# KROKUS

REBATED AND NON-REBATED INTERIOR STILE DOORS



KROKUS 1, GREKO WALNUT decor, DECO door handle

## SOLUTIONS AVAILABLE

**PL**

PL Standard

**CZ**

CZ Standard

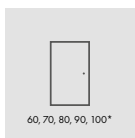

single-sash door

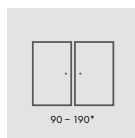

double doors

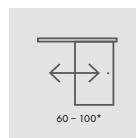

single-sash  
sliding door

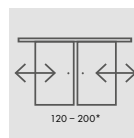

double-sash  
sliding door

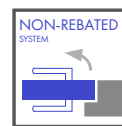

NON-REBATED  
SYSTEM

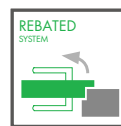

REBATED  
SYSTEM

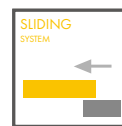

SLIDING  
SYSTEM

### AVAILABLE DOOR SASH WIDTHS

60

70

80

90

100

### MDF STILE

for GREKO, PREMIUM and CPL veneers





## CONSTRUCTION

- Rebated or non-rebated door sash made in STILE technology.
- Vertical and horizontal MDF stile covered with GREKO, PREMIUM, ST CPL or ST CPL veneers with AntiFinger coating. **NEW**
- HDF boards, 4 mm thick, covered with GREKO, CPL or Premium veneer.
- Brushed aluminium inserts.

## HARDWARE

- 3 silver 2-pin hinges adjustable in the horizontal plane in the rebated door sash.
- 3 hinges hidden in the non-rebated door sash in silver (optionally in black for an extra charge); hinges are delivered and priced with the door frame.
- A lever tumbler lock in the rebated door sash and a magnetic lock in the non-rebated door sash, key-operated, cylinder lock or silver-coloured blockade; optional black magnetic lock for an extra charge.

## GLAZING

- Standard frosted or transparent 4 mm tempered glass and VSG 221 laminated glass, safety glass, smooth on both sides, available at an extra charge.
- Possibility of changing the glazing side to REVERSE (OBVERSE standard glazing).

### GREKO



### PREMIUM



### CPL



### EXTRA CHARGE

Ventilation undercut or recuperation shortcut.

Wood-like plastic sleeves (4 pcs.).

Round and square metal sleeves (4 pcs.) brushed nickel, patina, white and black finish.

Ventilation grille (only for door sash widths: 80, 90, 100).

Rebated and non-rebated "100" door sash.

Drop down gasket.

VSG 221 laminated glass, frosted glass or black safety glass, smooth on both sides.

Metal covers for hinges in the rebated door sash (colour: brushed nickel, patina, glossy chrome, glossy brass, white and black)

Replaced with a black magnetic lock for non-rebated door sashes.

<sup>1)</sup> Smooth white veneer imitating painted surface.

<sup>2)</sup> Special **AntiFinger** **NEW** coating to reduce dirt and fingerprints.

# JUKA

REBATED AND NON-REBATED INTERIOR STILE DOORS



JUKA 4, MEDIUM OAK GREKO decor, TOPAZ INOX door handle

## SOLUTIONS AVAILABLE

**PL**

PL Standard

**CZ**

CZ Standard

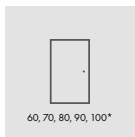

single-sash door

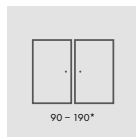

double doors

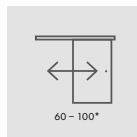

single-sash sliding door

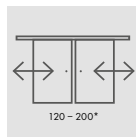

double-sash sliding door

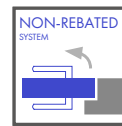

NON-REBATED SYSTEM

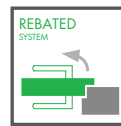

REBATED SYSTEM

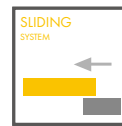

SLIDING SYSTEM

### AVAILABLE DOOR SASH WIDTHS

60

70

80

90

100

### MDF STILE

for GREKO, PREMIUM and CPL veneers



## CONSTRUCTION

- Rebated or non-rebated door sash made in STILE technology.
- Vertical and horizontal MDF stile covered with GREKO, PREMIUM, ST CPL or ST CPL veneers with AntiFinger coating. NEW
- HDF boards, 4 mm thick, covered with GREKO, CPL or Premium veneer.

## HARDWARE

- 3 silver 2-pin hinges adjustable in the horizontal plane in the rebated door sash.
- 3 hinges hidden in the non-rebated door sash in silver (optionally in black for an extra charge); hinges are delivered and priced with the door frame.
- A lever tumbler lock in the rebated door sash and a magnetic lock in the non-rebated door sash, key-operated, cylinder lock, economy lock or silver-coloured blockade; optional black magnetic lock for an extra charge.

## GLAZING

- Standard frosted or transparent 4 mm tempered glass and VSG 221 laminated glass, safety glass, smooth on both sides, available at an extra charge.
- Possibility of changing the glazing side to REVERSE (OBSERVE standard glazing).



### GREKO



### PREMIUM



### CPL



### EXTRA CHARGE

- Ventilation undercut or recuperation shortcut.
- Wood-like plastic sleeves (4 pcs.).
- Round and square metal sleeves (4 pcs.) brushed nickel, patina, white and black finish.
- Ventilation grille (only for door sash widths: 80, 90, 100).
- Rebated and non-rebated "100" door sash.
- Drop down gasket.

VSG 221 laminated glass, frosted glass or black safety glass, smooth on both sides. models: JUKA 1,2,3,4,5,6,7.

Metal covers for hinges in the rebated door sash (colour: brushed nickel, patina, glossy chrome, glossy brass, white and black)

Replaced with a black magnetic lock for non-rebated door sashes.

<sup>1)</sup> Smooth white veneer imitating painted surface.

<sup>2)</sup> Special **AntiFinger** NEW coating to reduce dirt and fingerprints.

# HIACYNT

REBATED AND NON-REBATED INTERIOR STILE DOORS

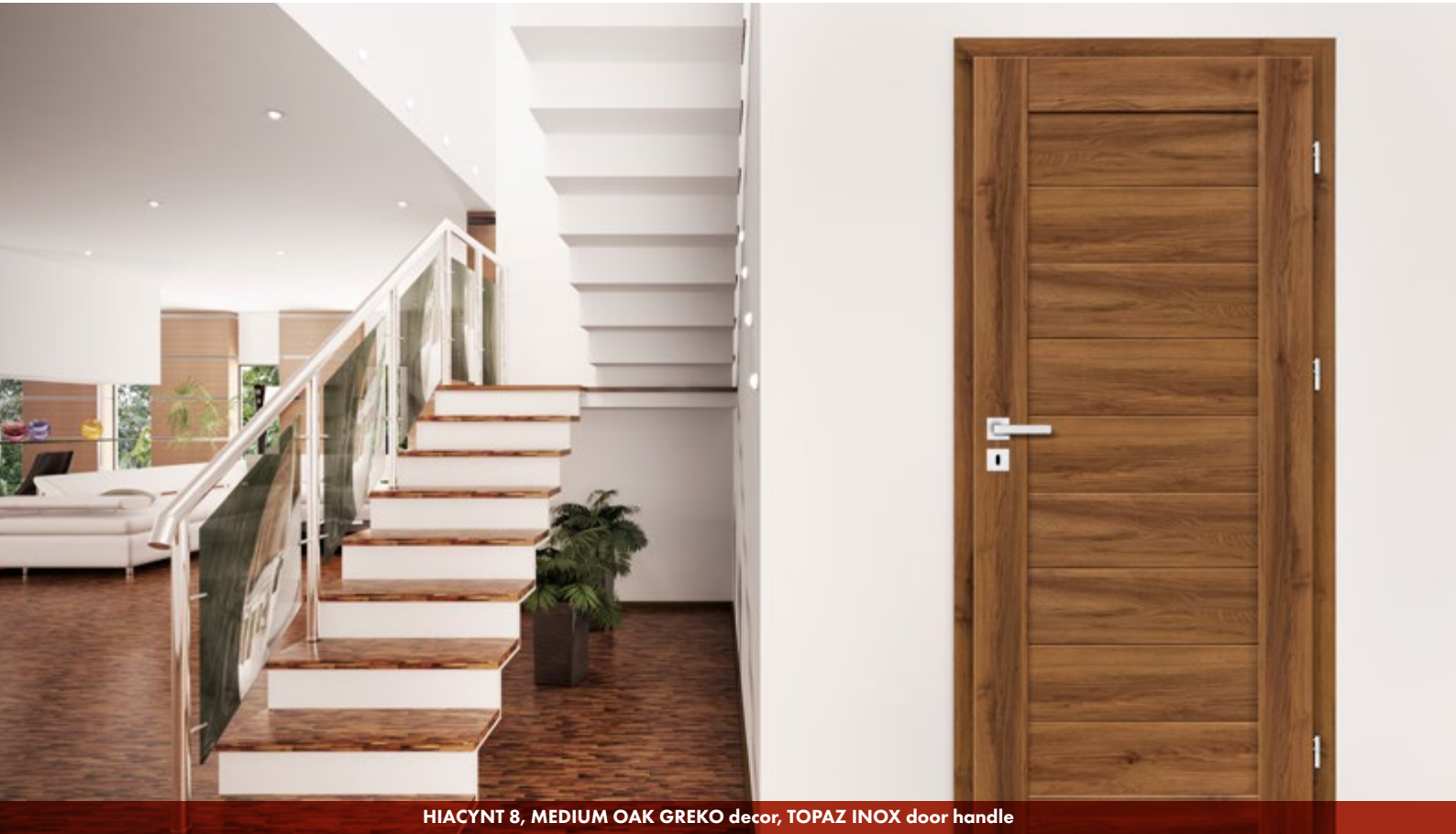

HIACYNT 8, MEDIUM OAK GREKO decor, TOPAZ INOX door handle

## SOLUTIONS AVAILABLE

**PL**

PL Standard

**CZ**

CZ Standard

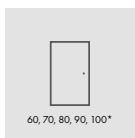

single-sash door

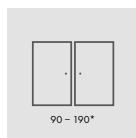

double doors

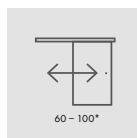

single-sash  
sliding door

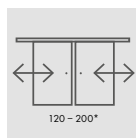

double-sash  
sliding door

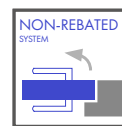

NON-REBATED  
SYSTEM

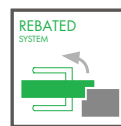

REBATED  
SYSTEM

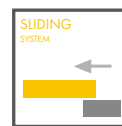

SLIDING  
SYSTEM

### AVAILABLE DOOR SASH WIDTHS

60

70

80

90

100

### MDF STILE

for GREKO, PREMIUM and CPL veneers



## CONSTRUCTION

- Rebated or non-rebated door sash made in STILE technology.
- vertical and horizontal MDF stile covered with GREKO, PREMIUM, ST CPL or ST CPL veneers with AntiFinger coating. **NEW**
- HDF boards, 22 mm thick, covered with GREKO, CPL or Premium veneer.

## HARDWARE

- 3 silver 2-pin hinges adjustable in the horizontal plane in the rebated door sash.
- 3 hinges hidden in the non-rebated door sash in silver (optionally in black for an extra charge); hinges are delivered and priced with the door frame.
- A lever tumbler lock in the rebated door sash and a magnetic lock in the non-rebated door sash, key-operated, cylinder lock, economy lock or silver-coloured blockade; optional black magnetic lock for an extra charge.

## GLAZING

- Standard frosted or transparent 4 mm tempered glass and VSG 221 laminated glass, safety glass, smooth on both sides, available at an extra charge.
- Possibility of changing the glazing side to REVERSE (OBSERVE standard glazing).



### GREKO



### PREMIUM



### CPL



### EXTRA CHARGE

Ventilation undercut or recuperation shortcut.

Wood-like plastic sleeves (4 pcs.).

Round and square metal sleeves (4 pcs.) brushed nickel, patina, white and black finish.

Ventilation grille (only for door sash widths: 80, 90, 100).

Rebated and non-rebated "100" door sash.

Drop down gasket.

VSG 221 laminated glass, frosted glass or black safety glass, smooth on both sides. models: HIACYNT 1, 2, 3, 4, 5, 6, 7.

Metal covers for hinges in the rebated door sash (colour: brushed nickel, patina, glossy chrome, glossy brass, white and black)

Replaced with a black magnetic lock for non-rebated door sashes.

<sup>1)</sup> Smooth white veneer imitating painted surface.

<sup>2)</sup> Special **AntiFinger** **NEW** coating to reduce dirt and fingerprints.

# FORSYCJA

REBATED AND NON-REBATED INTERIOR STILE DOORS



FORSYCJA 3, GREKO WHITE decor, MAT BLACK CUBE door handle

## SOLUTIONS AVAILABLE

**PL**

PL Standard

**CZ**

CZ Standard

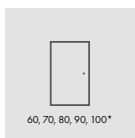

single-sash door

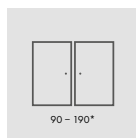

double doors

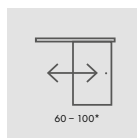

single-sash  
sliding door

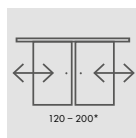

double-sash  
sliding door

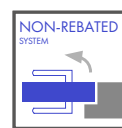

NON-REBATED  
SYSTEM

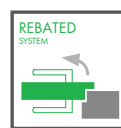

REBATED  
SYSTEM

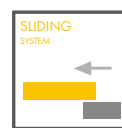

SLIDING  
SYSTEM

AVAILABLE **DOOR SASH WIDTHS**

60

70

80

90

100

### MDF STILE

for GREKO, PREMIUM and CPL veneers



## CONSTRUCTION

- Rebated or non-rebated door sash made in STILE technology.
- vertical and horizontal MDF stile covered with GREKO, PREMIUM, ST CPL or ST CPL veneers with AntiFinger coating.
- HDF boards, 4 mm thick, covered with GREKO, CPL or Premium veneer.

## HARDWARE

- 3 silver 2-pin hinges adjustable in the horizontal plane in the rebated door sash.
- 3 hinges hidden in the non-rebated door sash in silver (optionally in black for an extra charge); hinges are delivered and priced with the door frame.
- A lever tumbler lock in the rebated door sash and a magnetic lock in the non-rebated door sash, key-operated, cylinder lock, economy lock or silver-coloured blockade; optional black magnetic lock for an extra charge.

## GLAZING

- Standard frosted or transparent 4 mm tempered glass and VSG 221 laminated glass, safety glass, smooth on both sides, available at an extra charge.
- Possibility of changing the glazing side to REVERSE (OBSERVE standard glazing).

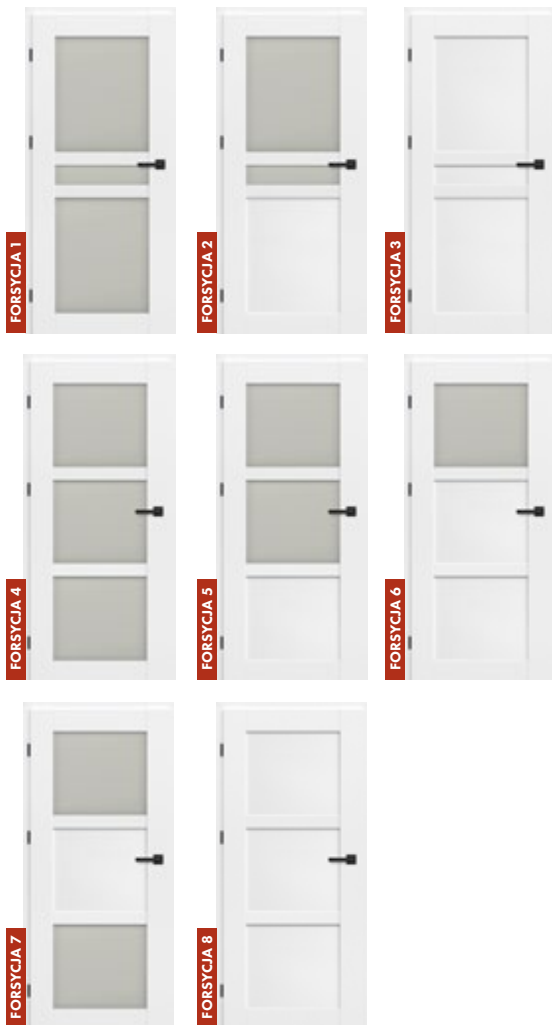

### GREKO



### PREMIUM



### CPL



### EXTRA CHARGE

Ventilation undercut or recuperation shortcut.

Wood-like plastic sleeves (4 pcs.).

Round and square metal sleeves (4 pcs.) brushed nickel, patina, white and black finish.

Ventilation grille (only for door sash widths: 80, 90, 100).

Rebated and non-rebated "100" door sash.

Drop down gasket.

VSG 221 laminated glass, frosted glass or black safety glass, smooth on both sides. models: FORSYCJA 1, 2, 4, 5, 6, 7.

Metal covers for hinges in the rebated door sash (colour: brushed nickel, patina, glossy chrome, glossy brass, white and black)

Replaced with a black magnetic lock for non-rebated door sashes.

<sup>1)</sup> Smooth white veneer imitating painted surface.

<sup>2)</sup> Special **AntiFinger** **NEW** coating to reduce dirt and fingerprints.

# DEBECJA

REBATED AND NON-REBATED INTERIOR STILE DOORS



DEBECJA 1, CAPPUCCINO ST CPL decor, BELLA door handle in glossy brass

## SOLUTIONS AVAILABLE

PL

PL Standard

CZ

CZ Standard

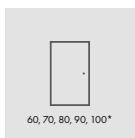

single-sash door

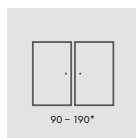

double doors

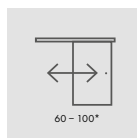

single-sash  
sliding door

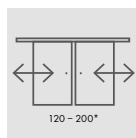

double-sash  
sliding door

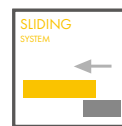
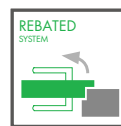
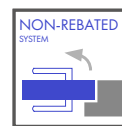

AVAILABLE **DOOR SASH WIDTHS**

60

70

80

90

100

### MDF STILE

for GREKO, PREMIUM and CPL veneers





## CONSTRUCTION

- Rebated or non-rebated door sash made in STILE technology.
- Vertical and horizontal MDF stile covered with GREKO, PREMIUM, ST CPL or ST CPL veneers with AntiFinger coating. **NEW**
- HDF boards, 4 mm thick, covered with GREKO, CPL or Premium veneer.
- A very wide bar.

## HARDWARE

- 3 silver 2-pin hinges adjustable in the horizontal plane in the rebated door sash.
- 3 hinges hidden in the non-rebated door sash in silver (optionally in black for an extra charge); hinges are delivered and priced with the door frame.
- A lever tumbler lock in the rebated door sash and a magnetic lock in the non-rebated door sash, key-operated, cylinder lock or silver-coloured blockade; optional black magnetic lock for an extra charge.

## GLAZING

- Standard frosted or transparent 4 mm tempered glass and VSG 221 laminated glass, safety glass, smooth on both sides, available at an extra charge.
- Possibility of changing the glazing side to REVERSE (OBVERSE standard glazing).

### GREKO



### PREMIUM



### CPL



### EXTRA CHARGE

Ventilation undercut or recuperation shortcut.

Wood-like plastic sleeves (4 pcs.).

Round and square metal sleeves (4 pcs.) brushed nickel, patina, white and black finish.

Ventilation grille (only for door sash widths: 80, 90, 100).

Rebated and non-rebated "100" door sash.

Drop down gasket.

VSG 221 laminated glass, frosted glass or black safety glass, smooth on both sides.

Metal covers for hinges in the rebated door sash (colour: brushed nickel, patina, glossy chrome, glossy brass, white and black)

Replaced with a black magnetic lock for non-rebated door sashes.

<sup>1)</sup> Smooth white veneer imitating painted surface.

<sup>2)</sup> Special **AntiFinger** **NEW** coating to reduce dirt and fingerprints.

# AZALIA

REBATED AND NON-REBATED INTERIOR STILE DOORS



AZALIA 1, OAK ST CPL decor, CUBE door handle brushed matt chrome

## SOLUTIONS AVAILABLE

**PL**

PL Standard

**CZ**

CZ Standard

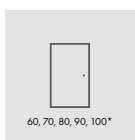

single-sash door

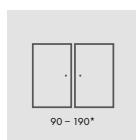

double doors

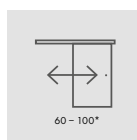

single-sash  
sliding door

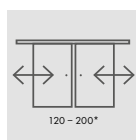

double-sash  
sliding door

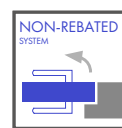

NON-REBATED  
SYSTEM

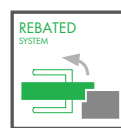

REBATED  
SYSTEM

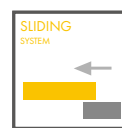

SLIDING  
SYSTEM

### AVAILABLE DOOR SASH WIDTHS

60

70

80

90

100

### MDF STILE

for GREKO, PREMIUM and CPL veneers



## CONSTRUCTION

- Rebated or non-rebated door sash made in STILE technology.
- Vertical and horizontal MDF stile covered with GREKO, PREMIUM, ST CPL or ST CPL veneers with AntiFinger coating. **NEW**
- HDF boards, 4 mm thick, covered with GREKO, CPL or Premium veneer.

## HARDWARE

- 3 silver 2-pin hinges adjustable in the horizontal plane in the rebated door sash.
- 3 hinges hidden in the non-rebated door sash in silver (optionally in black for an extra charge); hinges are delivered and priced with the door frame.
- A lever tumbler lock in the rebated door sash and a magnetic lock in the non-rebated door sash, key-operated, cylinder lock, economy lock or silver-coloured blockade; optional black magnetic lock for an extra charge.

## GLAZING

- Standard frosted or transparent 4 mm tempered glass and VSG 221 laminated glass, safety glass, smooth on both sides, available at an extra charge.
- Possibility of changing the glazing side to REVERSE (OBSERVE standard glazing).



### GREKO



### PREMIUM



### CPL



### EXTRA CHARGE

- Ventilation undercut or recuperation shortcut.
- Woodgrain plastic bushings.
- Round and square metal sleeves (4 pcs.) brushed nickel, patina, white and black finish.
- Ventilation grille (only for door sash widths: 80, 90, 100).
- Rebated and non-rebated "100" door sash.
- Drop down gasket.

- VSG 221 laminated glass, frosted glass or black safety glass, smooth on both sides.
- Metal covers for hinges in the rebated door sash (colour: brushed nickel, patina, glossy chrome, glossy brass, white and black)
- Replaced with a black magnetic lock for non-rebated door sashes.

<sup>1)</sup> Smooth white veneer imitating painted surface.  
<sup>2)</sup> Special **AntiFinger** **NEW** coating to reduce dirt and fingerprints.

# MISKANT

PAINTED REBATED AND NON-REBATED DOOR SASHES



MISKANT 2, handle BELLA slim black mat

## SOLUTIONS AVAILABLE

**PL**

PL Standard

**CZ**

CZ Standard

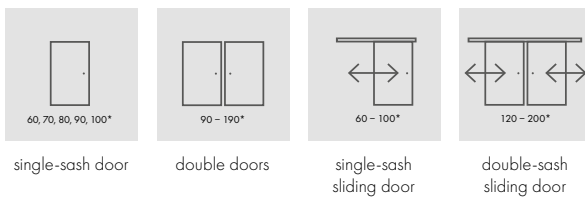

single-sash door

double doors

single-sash sliding door

double-sash sliding door

AVAILABLE DOOR SASH WIDTHS

60 70 80 90 100

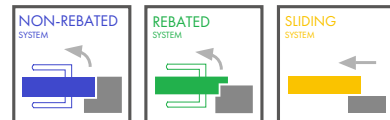

STANDARD **GLAZING "OBVERSE"**



CUSTOM **GLAZING "REVERSE"**



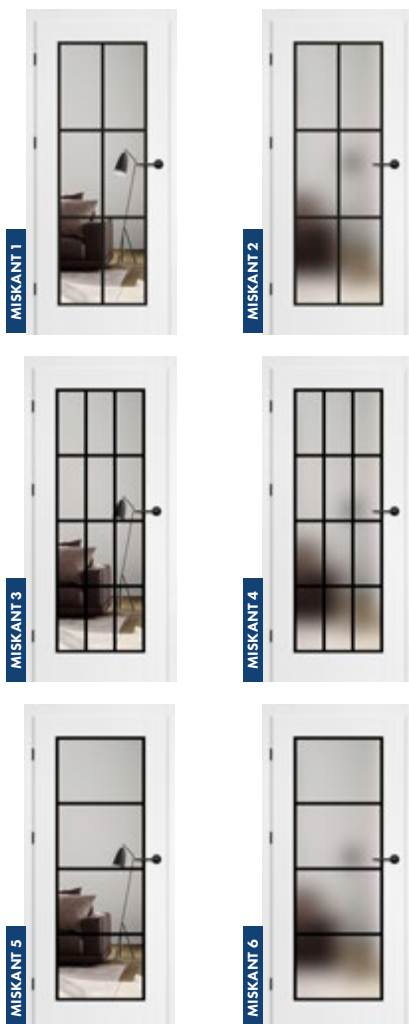

## CONSTRUCTION

- Rebated or non-rebated door sash made in STILE technology.
- Vertical and horizontal rails made of MDF covered with veneer and painted with a resistant UV varnish.

## FINISH

- Door sashes and frames painted with water-based varnish cured with UV technology, which allows for high resistance to difficult conditions of use.

## HARDWARE

- 3 silver 2-pin hinges adjustable in the horizontal plane in the rebated door sash.
- 3 hinges hidden in the non-rebated door sash in silver (optionally in black for an extra charge); hinges are delivered and priced with the door frame.
- A lever tumbler lock in the rebated door sash and a magnetic lock in the non-rebated door sash, key-operated, cylinder lock, economy lock or silver-coloured blockade; optional black magnetic lock for an extra charge.

## GLAZING

- Frosted or transparent 4 mm tempered glass or VSG laminated glass with an internal application at an extra charge.
- Possibility of changing the glazing side to REVERSE (OBVERSE standard glazing).
- Black lines painted in screen printing technology on one side of the glass with a width (thickness) of 18 mm.

### PAINTED

white titanium UV



NEW

Black lines, 18mm wide, painted in screen printing technology

### EXTRA CHARGE

Ventilation undercut or recuperation shortcut.  
Rebated and non-rebated "100" door sash.  
Drop down gasket.

Metal covers for hinges in the rebated door sash (colour: brushed nickel, patina, glossy chrome, glossy brass, white and black)

Replaced with a black magnetic lock for non-rebated door sashes.

# TURAN

PAINTED REBATED AND NON-REBATED DOOR SASHES



TURAN 4, CUBE door handle black mat

## SOLUTIONS AVAILABLE

**PL**

PL Standard

**CZ**

CZ Standard

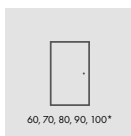

60, 70, 80, 90, 100\*

single-sash door

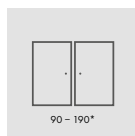

90 - 190\*

double doors

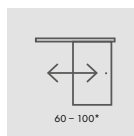

60 - 100\*

single-sash  
sliding door

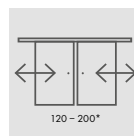

120 - 200\*

double-sash  
sliding door

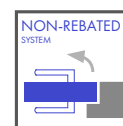

NON-REBATED  
SYSTEM

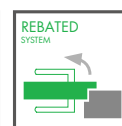

REBATED  
SYSTEM

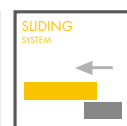

SLIDING  
SYSTEM

## AVAILABLE DOOR SASH WIDTHS

60

70

80

90

100

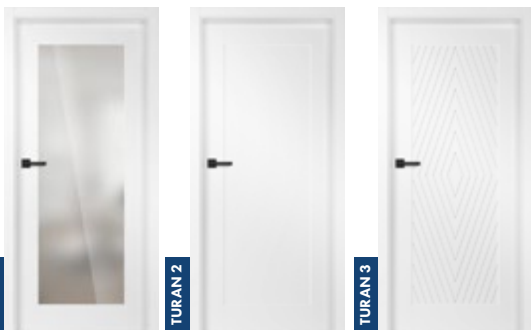

## CONSTRUCTION

- Rebated or non-rebated door sash made in STILE technology.
- Vertical and horizontal rails made of MDF covered with veneer and painted with a resistant UV varnish.
- Panels made of 16 mm HDF milled and painted with resistant UV varnish.

## FINISH

- Door sashes and frames painted with water-based varnish cured with UV technology, which allows for high resistance to difficult conditions of use.

## HARDWARE

- 3 silver 2-pin hinges adjustable in the horizontal plane in the rebated door sash.
- 3 hinges hidden in the non-rebated door sash in silver (optionally in black for an extra charge); hinges are delivered and priced with the door frame.
- A lever tumbler lock in the rebated door sash and a magnetic lock in the non-rebated door sash, key-operated, cylinder lock, economy lock or silver-coloured blockade; optional black magnetic lock for an extra charge.

## GLAZING

- Model TURAN 1 8 mm tempered glass or, at an extra charge, laminated glass, frosted glass or black safety glass, smooth on both sides.
- Model TURAN 7 available on one side with a mirror. The other side - WHITE TITANIUM UV painted board. Obverse - mirror on the hinge side.

### PAINTED

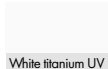

White titanium UV

### MOULDING

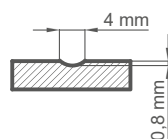

### EXTRA CHARGE

Ventilation undercut or recuperation shortcut.  
Rebated and non-rebated "100" door sash.  
Drop down gasket.

VSG 221 laminated glass, frosted or black safety glass, smooth on both sides (applies to TURAN 1).

Metal covers for hinges in the rebated door sash (colour: brushed nickel, patina, glossy chromée, glossy brass, white and black)

Replaced with a black magnetic lock for non-rebated door sashes..

# LAURENCJA

PAINTED REBATED AND NON-REBATED DOOR SASHES



LAURENCJA 1, black VSG glass, BELLA slim black matt door handle

## SOLUTIONS AVAILABLE

**PL**

PL Standard

**CZ**

CZ Standard

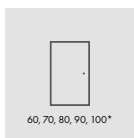

single-sash door

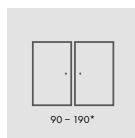

double doors

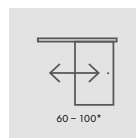

single-sash sliding door

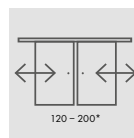

double-sash sliding door

AVAILABLE DOOR SASH WIDTHS

60

70

80

90

100

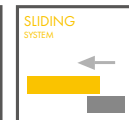
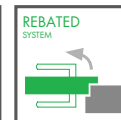
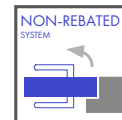



## CONSTRUCTION

- Rebated or non-rebated door sash made in STILE technology.
- Vertical and horizontal rails made of MDF covered with veneer and painted with a resistant UV varnish.
- Panels made of 4 mm thick HDF board, painted with a resistant UV varnish.

## FINISH

- Door sashes and frames painted with water-based varnish cured with UV technology, which allows for high resistance to difficult conditions of use.

## HARDWARE

- 3 silver 2-pin hinges adjustable in the horizontal plane in the rebated door sash.
- 3 hinges hidden in the non-rebated door sash in silver (optionally in black for an extra charge); hinges are delivered and priced with the door frame.
- A lever tumbler lock in the rebated door sash and a magnetic lock in the non-rebated door sash, key-operated, cylinder lock, economy lock or silver-coloured blockade; optional black magnetic lock for an extra charge.

## GLAZING

- Frosted or transparent tempered glass as standard, and VSG 221 laminated glass for an extra charge, frosted or black safety glass, smooth on both sides.
- Possibility of changing the glazing side to REVERSE (OBVERSE standard glazing).

### PAINTED

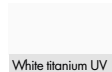

White titanium UV

### EXTRA CHARGE

Ventilation undercut or recuperation shortcut.  
 Rebated and non-rebated "100" door sash.  
 Drop down gasket.

VSG 221 laminated glass, frosted glass or black safety glass, smooth on both sides.

Metal covers for hinges in the rebated door sash (colour: brushed nickel, patina, glossy chrome, glossy brass, white and black).

Replaced with a black magnetic lock for non-rebated door sashes.

# NEMEZJA

PAINTED REBATED AND NON-REBATED DOOR SASHES



NEMEZJA 6, handle BELLA slim shiny brass

## SOLUTIONS AVAILABLE

PL

PL Standard

CZ

CZ Standard

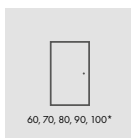

single-sash door

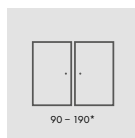

double doors

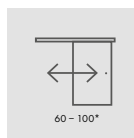

single-sash sliding door

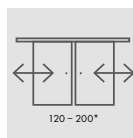

double-sash sliding door

AVAILABLE DOOR SASH WIDTHS

60

70

80

90

100

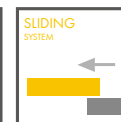
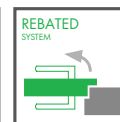
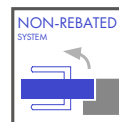

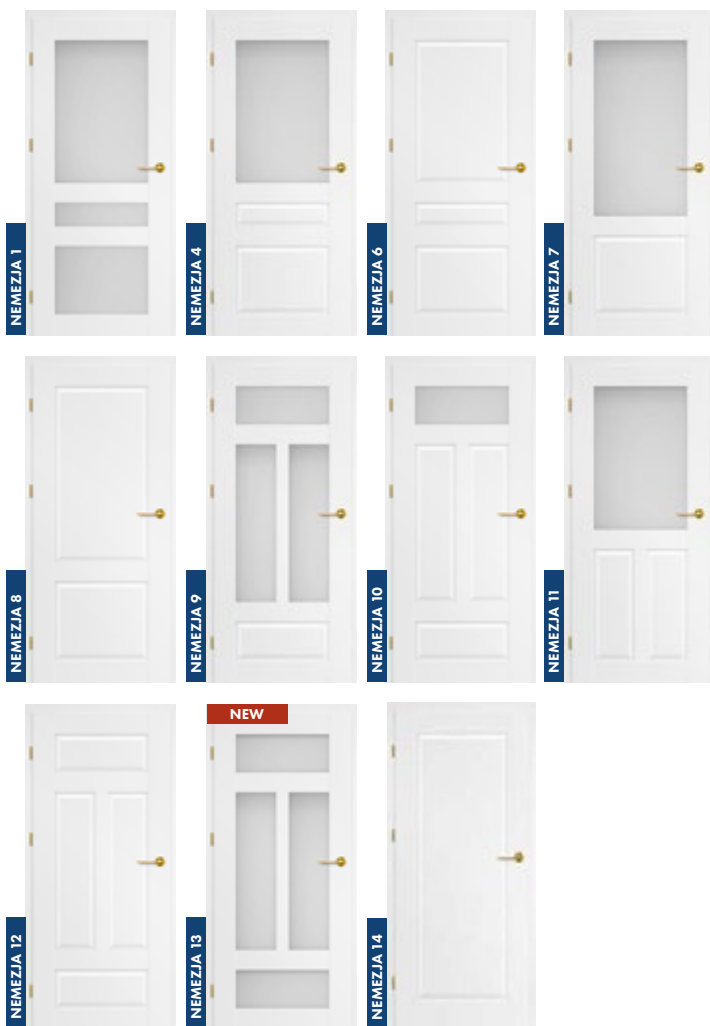

## CONSTRUCTION

- Rebated or non-rebated door sash made in STILE technology.
- Vertical and horizontal rails made of MDF covered with veneer and painted with a resistant UV varnish.
- Panels made of 16 mm thick HDF board, painted with a resistant UV varnish.

## FINISH

- Door sashes and frames painted with water-based varnish cured with UV technology, which allows for high resistance to difficult conditions of use.

## HARDWARE

- 3 silver 2-pin hinges adjustable in the horizontal plane in the rebated door sash.
- 3 hinges hidden in the non-rebated door sash in silver (optionally in black for an extra charge); hinges are delivered and priced with the door frame.
- A lever tumbler lock in the rebated door sash and a magnetic lock in the non-rebated door sash, key-operated, cylinder lock, economy lock or silver-coloured blockade; optional black magnetic lock for an extra charge.

## GLAZING

- Frosted or transparent tempered glass as standard, and VSG 221 laminated glass for an extra charge, frosted or black safety glass, smooth on both sides.
- Possibility of changing the glazing side to REVERSE (OBERSE standard glazing).

### PAINTED

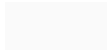

White titanium UV

### EXTRA CHARGE

Ventilation undercut or recuperation shortcut.

Rebated and non-rebated "100" door sash.

Drop down gasket.

laminated glass, frosted glass on both sides, smooth.

NEMEZJA 1  
NEMEZJA 9 | 13  
NEMEZJA 7  
NEMEZJA 4 | 11  
NEMEZJA 10

Metal covers for hinges in the rebated door sash (colour: brushed nickel, patina, glossy chrome, glossy brass, white and black).

Replaced with a black magnetic lock for non-rebated door sashes.

# UNO PREMIUM

LACQUERED DOOR SASHES REBATED, NON-REBATED AND REVERSIBLE



UNO PREMIUM, CUBE door handle black mat

## SOLUTIONS AVAILABLE

**PL**

PL Standard

**CZ**

CZ Standard

**PL 2112**

PL2112 Standard

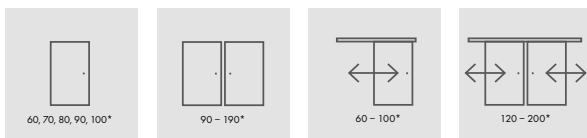

single-sash door

double doors

single-sash  
sliding door

double-sash  
sliding door

AVAILABLE **DOOR SASH WIDTHS**

60 70 80 90 100

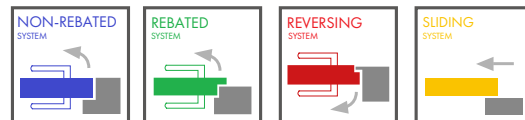



## CONSTRUCTION

- Rebated, reversible or non-rebated door sash.
- Internal wooden rail and stile set (sides, top and bottom MDF) covered with two HDF boards.
- "Honeycomb" stabilizing filling or full board filling for an extra charge.

## FINISH

- Door sashes and frames painted with water-based varnish cured with UV technology, which allows for high resistance to difficult conditions of use.
- Sash edge made in standard technology.

## HARDWARE

- 3 silver 2-pin hinges adjustable in the horizontal plane in the rebated door sash.
- 3 hinges hidden in the non-rebated door sash in silver (optionally in black for an extra charge); hinges are delivered and priced with the door frame.
- A lever tumbler lock in the rebated door sash and a magnetic lock in the non-rebated door sash, key-operated, cylinder lock, economy lock or silver-coloured blockade; optional black magnetic lock for an extra charge.

## PAINTED

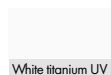

## EXTRA CHARGE

Reversible sash or recuperative shortcut.

Full board filling.

Ventilation undercut.

Rebated and non-rebated "100" door sash.

Drop down gasket.

Additional bottom beam (possibility of shortening the sash on your own to a maximum of 8 cm) Polish standard

Metal covers for hinges in the rebated door sash (colour: brushed nickel, patina, glossy chrome, glossy brass, white and black).

Replaced with a black magnetic lock for non-rebated and reversible sashes.

Stainless steel porthole; polished "chrome" or brushed "satin" and black matt; frosted decormat glass, colourless glass, diam. porthole: ext. 235 mm, external 350 mm.

PL2112 Standard <sup>1)</sup>

<sup>1)</sup> Applies only to the rebated, non-rebated and non-rebated door sash for the SP1N and SP2N wall systems.

# MILDA

LACQUERED DOOR SASHES REBATED, NON-REBATED AND REVERSIBLE



MILDA 4, handle CUBE PREMIUM black

## SOLUTIONS AVAILABLE

**PL**

PL Standard

**CZ**

CZ Standard

**PL2112**

PL2112 Standard

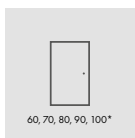

single-sash door

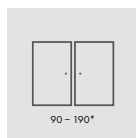

double doors

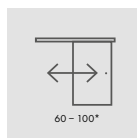

single-sash  
sliding door

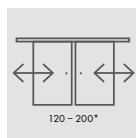

double-sash  
sliding door

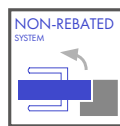

NON-REBATED  
SYSTEM

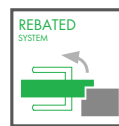

REBATED  
SYSTEM

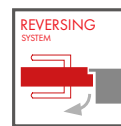

REVERSING  
SYSTEM

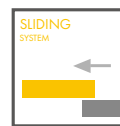

SLIDING  
SYSTEM

### AVAILABLE DOOR SASH WIDTHS

60

70

80

90

100

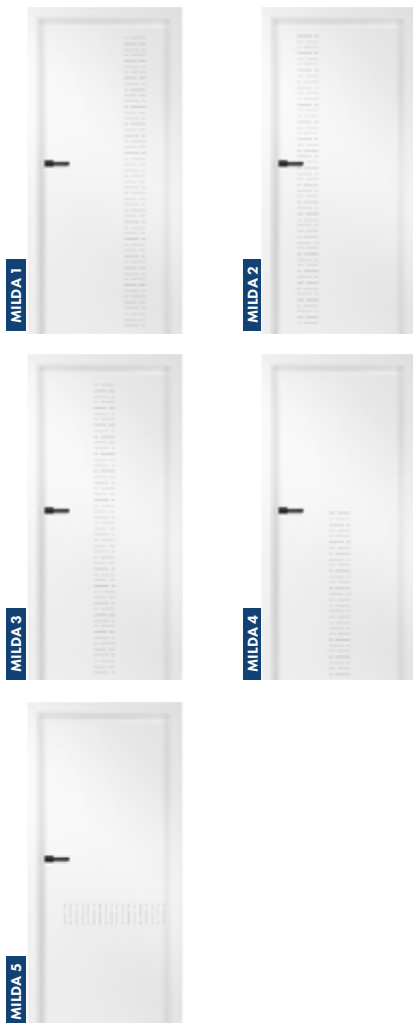

## CONSTRUCTION

- Rebated, reversible or non-rebated door sash.
- Internal wooden rail and stile set (sides, MDF top and bottom) covered with two HDF boards.
- "Honeycomb" stabilizing filling or, at an extra charge, full plate filling.

## FINISH

- Door sashes and frames painted with water-based varnish cured with UV technology, which allows for high resistance to difficult conditions of use.
- The sash edge is made in standard or non-rebated technology.

## HARDWARE

- 3 silver 2-pin hinges adjustable in the horizontal plane in the rebated door sash.
- 3 hinges hidden in the non-rebated door sash in silver (optionally in black for an extra charge); hinges are delivered and priced with the door frame.
- A lever tumbler lock in the rebated door sash and a magnetic lock in the non-rebated door sash, key-operated, cylinder lock, economy lock or silver-coloured blockade; optional black magnetic lock for an extra charge.

### PAINTED

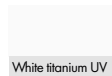

### MOULDING

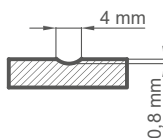

### EXTRA CHARGE

Reversible sash  
 Full board filling.  
 Rebated and non-rebated "100" door sash.  
 Drop down gasket.  
 Replacement for magnetic lock in black for doorless and reversible sashes.

Metal covers for hinges in the rebated door sash (colour: brushed nickel, patina, glossy chrome, glossy brass, white and black).

Ventilation undercut or recuperation shortcut.

Additional bottom beam (possibility of shortening the sash on your own to a maximum of 8 cm)

PL2112 Standard <sup>1)</sup>

<sup>1)</sup> Applies only to the rebated, non-rebated and non-rebated door sash for the SP1N and SP2N wall systems.

# BALDUR

LACQUERED DOOR SASHES REBATED, NON-REBATED AND REVERSIBLE



BALDUR 1, CUBE PREMIUM handle, VSG 441 black laminated glass

## SOLUTIONS AVAILABLE

**PL**

PL Standard

**CZ**

CZ Standard

**PL 2112**

PL Standard

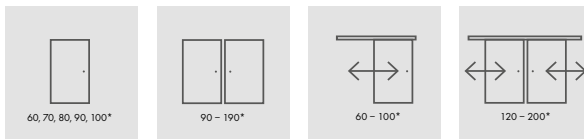

single-sash door

double doors <sup>(1)</sup>

single-sash sliding door <sup>(1) (3)</sup>

double-sash sliding door <sup>(1) (3)</sup>

### AVAILABLE DOOR SASH WIDTHS

60 70 80 90 100

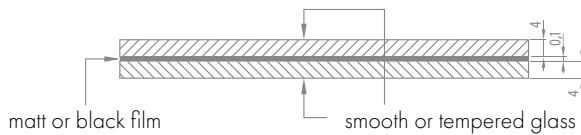
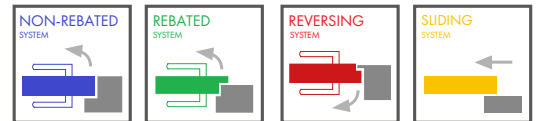

Standard VSG/ESG fused and tempered  
milky or black glass



## CONSTRUCTION

- Rebated, reversible or non-rebated door sash.
- Internal wooden rail and stile set (sides, MDF top and bottom) covered with two HDF boards.
- "Honeycomb" stabilizing filling or, at an extra charge, full plate filling.

## FINISH

- Door sashes and frames painted with water-based varnish cured with UV technology, which allows for high resistance to difficult conditions of use.
- The sash edge is made in standard or non-rebated technology.
- In sliding systems, BALDUR 1 has a visible profile (17mm high) in aluminium or black in the lower part of the glass.

## HARDWARE

- 3 silver 2-pin hinges adjustable in the horizontal plane in the rebated door sash.
- 3 hinges hidden in the non-rebated door sash in silver (optionally in black for an extra charge); hinges are delivered and priced with the door frame.
- A lever tumbler lock in the rebated door sash and a magnetic lock in the non-rebated door sash, key-operated, cylinder lock, economy lock or silver-coloured blockade; optional black magnetic lock for an extra charge.

## GLAZING

- BALDUR 1, 3, 5 as standard, laminated and toughened glass VSG/ESG 441, safety glass, frosted or black, smooth on both sides.
- Fixed glazing width; BALDUR 1 - 50mm, BALDUR 3, 5 - 210mm.

### PAINTED

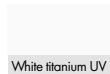

### MOULDING

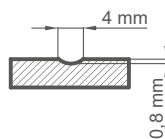

### VENTILATION UNDERCUTS



### EXTRA CHARGE

Reversible sash.

Rebated and non-rebated "100" door sash.

Ventilation undercut or recuperation shortcut.

Full board filling.

Drop down gasket (does not apply to the BALDUR 1, 3, 5 model).

Metal covers for hinges in the rebated door sash (colour: brushed nickel, patina, glossy chrome, glossy brass, white and black)

Additional bottom beam (the sash can be shortened on your own to a maximum of 8 cm, does not apply to the Baldur 1, 3, 5 model)

Replaced with a black magnetic lock for non-rebated and reversible sashes

PL2112 Standard <sup>2)</sup>

<sup>1)</sup> BALDUR 3, 5 models not available in sliding systems and in double-sash doors.

<sup>2)</sup> Applies only to the rebated, non-rebated and non-rebated door sash for the SP1N and SP2N wall systems

<sup>3)</sup> BALDUR 1 model not available in wall-mounted systems

# SYLENA

LACQUERED DOOR SASHES REBATED, NON-REBATED AND REVERSIBLE



SYLENA 2, CUBE door handle black mat

## SOLUTIONS AVAILABLE

**PL**

PL Standard

**CZ**

CZ Standard

**PL 2112**

PL Standard

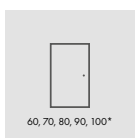

single-sash door

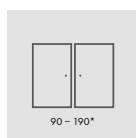

double doors

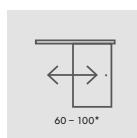

single-sash  
sliding door

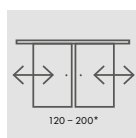

double-sash  
sliding door

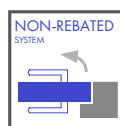

NON-REBATED  
SYSTEM

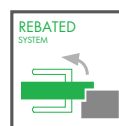

REBATED  
SYSTEM



REVERSING  
SYSTEM

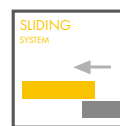

SLIDING  
SYSTEM

### AVAILABLE DOOR SASH WIDTHS

60

70

80

90

100



## CONSTRUCTION

- Rebated, reversible or non-rebated door sash.
- Internal wooden rail and stile set (sides, MDF top and bottom) covered with two HDF boards.
- "Honeycomb" stabilizing filling or, at an extra charge, full plate filling.

## FINISH

- Door sashes and frames painted with water-based varnish cured with UV technology, which allows for high resistance to difficult conditions of use.
- The sash edge is made in standard or non-rebated technology.

## HARDWARE

- 3 silver 2-pin hinges adjustable in the horizontal plane in the rebated door sash.
- 3 hinges hidden in the non-rebated door sash in silver (optionally in black for an extra charge); hinges are delivered and priced with the door frame.
- A lever tumbler lock in the rebated door sash and a magnetic lock in the non-rebated door sash, key-operated, cylinder lock, economy lock or silver-coloured blockade; optional black magnetic lock for an extra charge.

### PAINTED

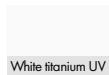

### MOULDING

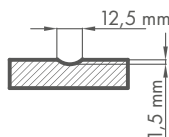

### EXTRA CHARGE

Reversible sash  
 Full board filling.  
 Ventilation undercut or recuperation shortcut.  
 Rebated and non-rebated "100" door sash.  
 Drop down gasket.

Metal covers for hinges in the rebated door sash (colour: brushed nickel, patina, glossy chrome, glossy brass, white and black).

Additional bottom beam (the sash can be shortened on your own to a maximum of 8 cm)

Replaced with a black magnetic lock for non-rebated and reversible sashes

PL2112 Standard <sup>1)</sup>

<sup>1)</sup> Applies only to the rebated, non-rebated and non-rebated door sash for the SP1N and SP2N wall systems..

# ANUBIS

LACQUERED DOOR SASHES REBATED, NON-REBATED AND REVERSIBLE



ANUBIS 1, CUBE door handle black mat

## SOLUTIONS AVAILABLE

**PL**

PL Standard

**CZ**

CZ Standard

**PL 2112**

PL Standard

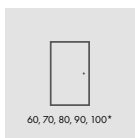

single-sash door

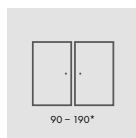

double doors

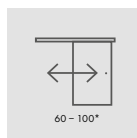

single-sash  
sliding door

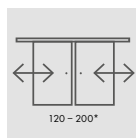

double-sash  
sliding door

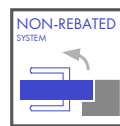

NON-REBATED  
SYSTEM

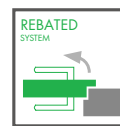

REBATED  
SYSTEM

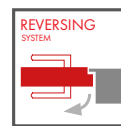

REVERSING  
SYSTEM

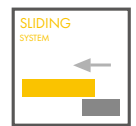

SLIDING  
SYSTEM

### AVAILABLE DOOR SASH WIDTHS

60

70

80

90

100



## CONSTRUCTION

- Rebated, reversible or non-rebated door sash.
- Internal wooden rail and stile set (sides, MDF top and bottom) covered with two HDF boards.
- "Honeycomb" stabilizing filling or, at an extra charge, full plate filling.

## FINISH

- Door sashes and frames painted with water-based varnish cured with UV technology, which allows for high resistance to difficult conditions of use.
- The sash edge is made in standard or non-rebated technology.

## HARDWARE

- 3 silver 2-pin hinges adjustable in the horizontal plane in the rebated door sash.
- 3 hinges hidden in the non-rebated door sash in silver (optionally in black for an extra charge); hinges are delivered and priced with the door frame.
- A lever tumbler lock in the rebated door sash and a magnetic lock in the non-rebated door sash, key-operated, cylinder lock, economy lock or silver-coloured blockade; optional black magnetic lock for an extra charge.

### PAINTED

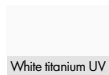

White titanium UV

### MOULDING

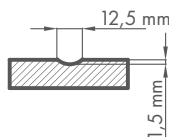

### EXTRA CHARGE

Reversible sash  
 Full board filling.  
 Ventilation undercut or recuperation shortcut.  
 Rebated and non-rebated "100" door sash.  
 Drop down gasket.

Metal covers for hinges in the rebated door sash (colour: brushed nickel, patina, glossy chrome, glossy brass, white and black).

Additional bottom beam (the sash can be shortened on your own to a maximum of 8 cm)

Replaced with a black magnetic lock for non-rebated and reversible sashes

PL2112 Standard <sup>1)</sup>

<sup>1)</sup> Applies only to the rebated, non-rebated and non-rebated door sash for the SP1N and SP2N wall systems..

# INLAYS

DECORATIVE INSERTION FLUSHED WITH THE SURFACE OF THE VENEER

## LUX INLAY OAK

BLACK ST CPL Door frame OAK NATURE PREMIUM Door sash



INLAYS LUX 213



INLAYS LUX 212



INLAYS LUX 204



INLAYS LUX 203



INLAYS LUX 216

## LUX INLAYS BRUSHED STEEL

Door frame and sash LIGHT GRAY ST CPL



INLAYS LUX 214



INLAYS LUX 207



INLAYS LUX 209



INLAYS LUX 113

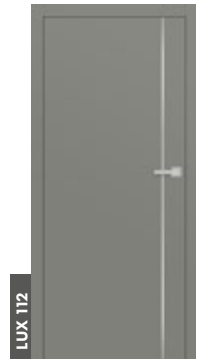

INLAYS LUX 112



INLAYS LUX 104



INLAYS LUX 103



INLAYS LUX 116



INLAYS LUX 114



INLAYS LUX 107

# INLAYS

DECORATIVE INSERTION FLUSHED WITH THE SURFACE OF THE VENEER

## LUX INLAYS GOLD

BLACK ST CPL Door frame BLACK ST CPL Door sash



INLAYS LUX 109



INLAYS LUX 413



INLAYS LUX 412



INLAYS LUX 104



INLAYS LUX 103



INLAYS LUX 414



INLAYS LUX 416

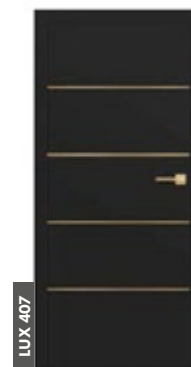

INLAYS LUX 407

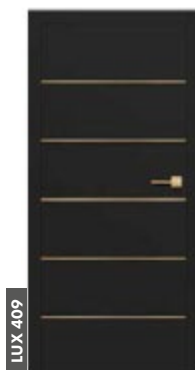

INLAYS LUX 409

**INLAYS are placed on both sides of the sash and flush with its plane. The inlay width is 8 mm.**

Available colours of LUX INLAY: brushed steel, black.

The presented INTARSJE can be used optionally for an extra charge on models:

- UNO PREMIUM veneer
- ALTAMURA 1
- HERSE SET 32 dB

# UNO PREMIUM

INTERIOR WINDOWS, DOOR OPEN, DOOR OPEN AND REVERSIBLE DOOR SASHES



UNO PREMIUM, WHITE PREMIUM decor, Bella black matt door handle

## SOLUTIONS AVAILABLE

**PL**

PL Standard

**CZ**

CZ Standard

**PL 2112**

PL Standard

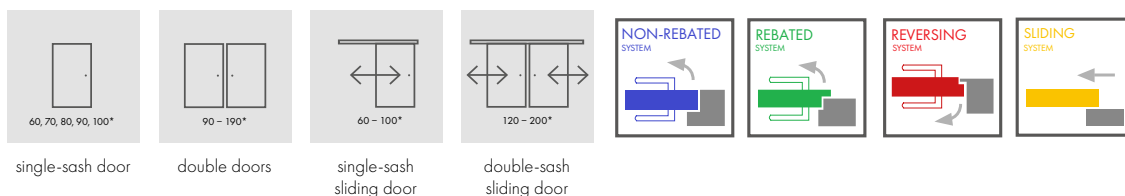

## AVAILABLE DOOR SASH WIDTHS

60 70 80 90 100

## TYPES OF EDGE FINISHING



Non-rebated



Standard



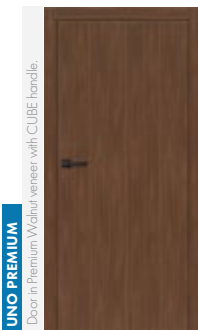

## CONSTRUCTION

- Rebated, reversible or non-rebated door sash.
- Internal wooden rail and stile set (sides, MDF top and bottom) covered with two HDF boards.
- "Honeycomb" stabilizing filling or, at an extra charge, full plate filling.
- For an additional charge, a full plate is available.

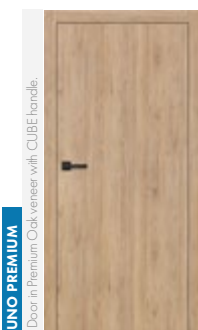

## FINISH

- HDF board covered with premium veneer.
- The sash edge is made in standard or non-rebated technology.
- The edge is covered with a border in the colour of the sash plane or optionally in smooth black (in the HORIZONTAL Nature OAK PREMIUM decor, a black border with a transverse structure).
- Inserts (inlays) colour: brushed steel, brushed gold, black, 8 mm wide, flush with the sash plane, on both sides of the sash.

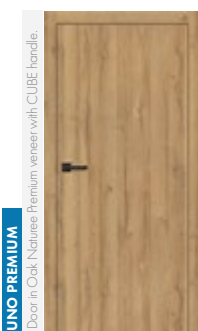

## HARDWARE

- 3 silver 2-pin hinges adjustable in the horizontal plane in the rebated door sash.
- 3 hinges hidden in the non-rebated door sash in silver (optionally in black for an extra charge); hinges are delivered and priced with the door frame.
- A lever tumbler lock in the rebated door sash and a magnetic lock in the non-rebated door sash, key-operated, cylinder lock, economy lock or silver-coloured blockade; optional black magnetic lock for an extra charge.

### PREMIUM

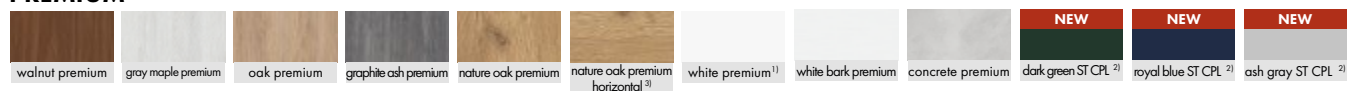

### EXTRA CHARGE

Reversible sash.

Solid board filling.

Reinforcement for door closer.

Arm door closer (silver, black, white, brown).

Additional bottom beam (possibility of shortening on your own to max. 8 m) standard PL and PL 2112.

Ventilation undercut, ventilation grille or recuperation shortcut.

Wood-like plastic sleeves (4 pcs).

Rebated and non-rebated "100" door sash.

Drop down gasket.

Round and square metal sleeves (4 pcs.) finish: brushed nickel, patina, white and black.

Metal covers for hinges in the rebated door sash (colour: brushed nickel, patina, glossy chrome, glossy brass, white and black).

Replacement with a black magnetic lock for non-rebated and reversible sashes.

Black sash edge finish.

Porthole - polished "chrome" or brushed "satin" stainless steel and black matt: frosted decormat glass, colourless glass, diam. porthole: ext. 235mm ext. 350mm.

Lux inlays; versions to choose from.

Standard PL and Standard PL2112<sup>2)</sup>

<sup>1)</sup> Smooth white veneer imitating painted surface.

<sup>2)</sup> Applies only to the rebated, non-rebated and non-rebated door sash for the SP1N and SP2N wall systems.

<sup>3)</sup> As part of the assembly, the door frame is made in the OAK NatureE PREMIUM decor

# BALDUR

INTERIOR WINDOWS, DOOR OPEN, DOOR OPEN AND REVERSIBLE DOOR SASHES



BALDUR 1, door sash in BLACK ST CPL decor, door frame in OAK Nature PREMIUM decor, BELLA door handle glossy brass

## SOLUTIONS AVAILABLE

PL

PL Standard

CZ

CZ Standard

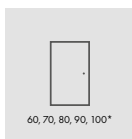

single-sash door

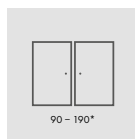

double doors <sup>13</sup>

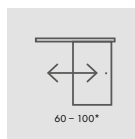

single-sash sliding door <sup>13</sup>

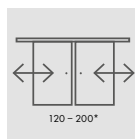

double-sash sliding door <sup>13</sup>

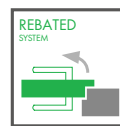
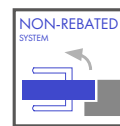

### AVAILABLE DOOR SASH WIDTHS

60

70

80

90

100

### VENTILATION UNDERCUTS

BALDUR 1



BALDUR 3



### TYPES OF EDGE FINISHING



Smooth black sash edge finish



Black transverse finish of the door sash edge

Non-rebated



Standard



Soft <sup>14</sup>



<sup>13</sup> The BALDUR 3 model is not available in sliding systems and in double-sash doors

<sup>14</sup> Only the soft version for BALDUR 1, rebated and non-rebated in the WHITE ST CPL decor and available only at an extra charge with a full board filling (soft option not available in the PL2112 standard)

## CONSTRUCTION

- Rebated, non-rebated or reversible door sash.
- Internal wooden rail and stile set (sides, MDF top and bottom) covered with two HDF boards.
- "Honeycomb" stabilizing filling or full board filling for an extra charge.

## FINISH

- HDF board covered with PREMIUM or CPL veneer.
- The edge of the door sash is made in the standard rebated or non-rebated technology in CPL 0.2 laminates, covered with ABS edgeband and only in the colour of the sash or with a standard black edgeband for an additional charge.
- The reversible door sash is available only in the STANDARD edge and in the PREMIUM and ST CPL decors.
- The edge of the sash is covered with a border in the colour of the plane or optionally in smooth black (in the decor OAK NatureE TRANSVERSE PREMIUM, a black border with a transverse structure). The edge in black colours is veneered circumferentially (two vertical and upper part) and at the glass.
- BALDUR 1 door sash, rebated and non-rebated only for the WHITE ST CPL decor, made optionally in the soft technology (no visible longitudinal edge joints of the veneer) requiring the use of a full board at an additional cost; soft technology is not included in the PL2112 standard.
- In the BALDUR 1 sliding systems, the lower part has a visible 17 mm high aluminium or black profile.

## HARDWARE

- 3 pin hinges screwed into the rebated door sash
- 3 hinges hidden in the non-rebated door sash and two hinges in a reversible door sash in silver (optional for an extra charge in black); hinges are supplied with the door frame
- Lever tumbler lock in the rebated door sash and magnetic lock in the non-rebated and reversible door sash: key lock, cylinder lock, saving lock or silver-coloured blockade; optional black magnetic lock for an extra charge

## GLAZING

- BALDUR 1, 3 frosted tempered glass 8 mm or at an extra charge laminated and toughened glass VSG/ESG 441 safety glass, frosted or black, smooth on both sides

### PREMIUM

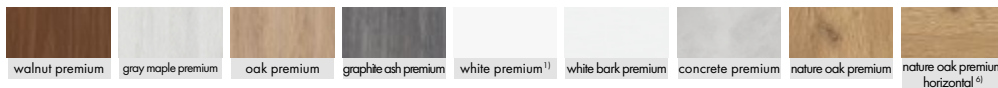

### CPL

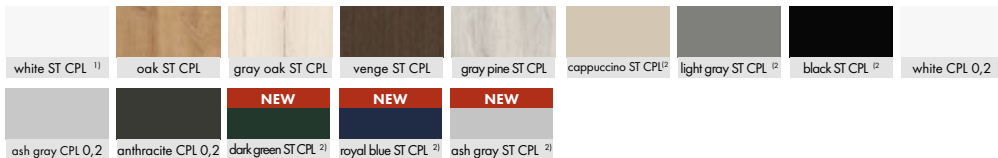

### EXTRA CHARGE

Reversible sash.

Full board filling.

Ventilation undercut or recuperation shortcut.

Rebated and non-rebated "100" door sash.

VSG/ESG 441 fused glass milk glass or black glass

Metal covers for hinges in the rebated door sash (colour: brushed nickel, patina, glossy chrome, glossy brass, white and black).  
Sash edge finish black

Replacement with a black magnetic lock for non-rebated and reversible sashes.

PL2112 Standard<sup>5)</sup>

<sup>1)</sup> Smooth white veneer imitating painted surface. <sup>2)</sup> A special Antifinger **NEW** coating that reduces dirt and fingerprints <sup>3)</sup> The BALDUR 3 model is not available in sliding systems and in double-sash doors <sup>4)</sup> Only the soft version for BALDUR 1, rebated and non-rebated in the WHITE ST CPL decor and available only at an extra charge with a full board filling (soft option not available in the PL2112 standard) <sup>5)</sup> Applies only to the rebated, non-rebated and non-rebated sash for the SP1N and SP2N wall systems. <sup>6)</sup> As part of the assembly, the door frame is made in the OAK NatureE PREMIUM decor.

# ALTAMURA

INTERIOR WINDOWS, DOOR OPEN, DOOR OPEN AND REVERSIBLE DOOR SASHES



ALTAMURA 5, OAK ST CPL decor, LINEA door handle

## SOLUTIONS AVAILABLE

**PL**

PL Standard

**CZ**

CZ Standard

**PL2112**

PL2112 Standard

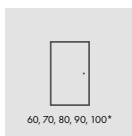

single-sash door

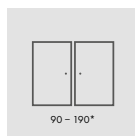

double doors

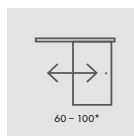

single-sash sliding door

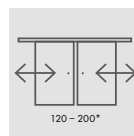

double-sash sliding door

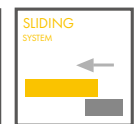
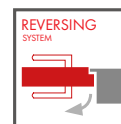
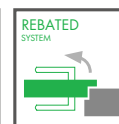
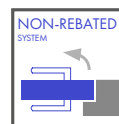

### AVAILABLE DOOR SASH WIDTHS

60

70

80

90

100

### TYPES OF EDGE FINISHING



Smooth black sash edge finish



Black transverse finish of the door sash edge

### GLAZING FRAME

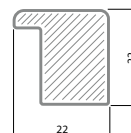

Non-rebated



Standard



## CONSTRUCTION

- Rebated, non-rebated or reversible door sash.
- MDF rail and stile set covered with two HDF boards in GREKO decors.
- Internal wooden rail and stile set (sides, MDF top and bottom) covered with two HDF boards in CPL and PREMIUM decors.
- "Honeycomb" stabilizing filling or, at an extra charge, full plate filling.

## FINISH

- HDF board covered with veneer.
- The sash edge is made in STANDARD technology (FINISH, GREKO, PREMIUM and CPL).
- CPL 0.2 and 0.7 laminates available only in the STANDARD edge, which is covered with ABS edging only in the colour of the door sash or with a standard black edging at an additional cost.
- The reversible door sash is available only in the STANDARD edge and in the GREKO, PREMIUM and ST CPL decors.
- Edge (standard or non-rebated finish) covered with a border in the colour of the surface or optionally in smooth black (in the Nature OAK TRANSVERSE PREMIUM decor, a black border with a transverse structure)

## HARDWARE

- Three pin hinges screwed into the rebated door sash.
- Three hinges hidden in the non-rebated door sash and two hinges in the reversible door sash in silver (optionally in black for an extra charge); hinges are delivered with the door frame
- A lever tumbler lock in the rebated door sash and a magnetic lock in the non-rebated door sash and reversible door sash with a key, cylinder lock, saving lock or with a silver blockade; optional black magnetic lock for an extra charge.

## GLAZING

- Decormat glass as standard - frosted, transparent or at an extra charge VSG 221 frosted safe, smooth on both sides.
- Possibility of changing the glazing side to REVERSE (OBSERVE standard glazing).

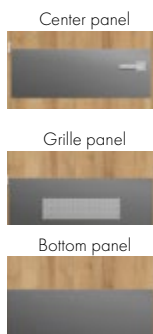
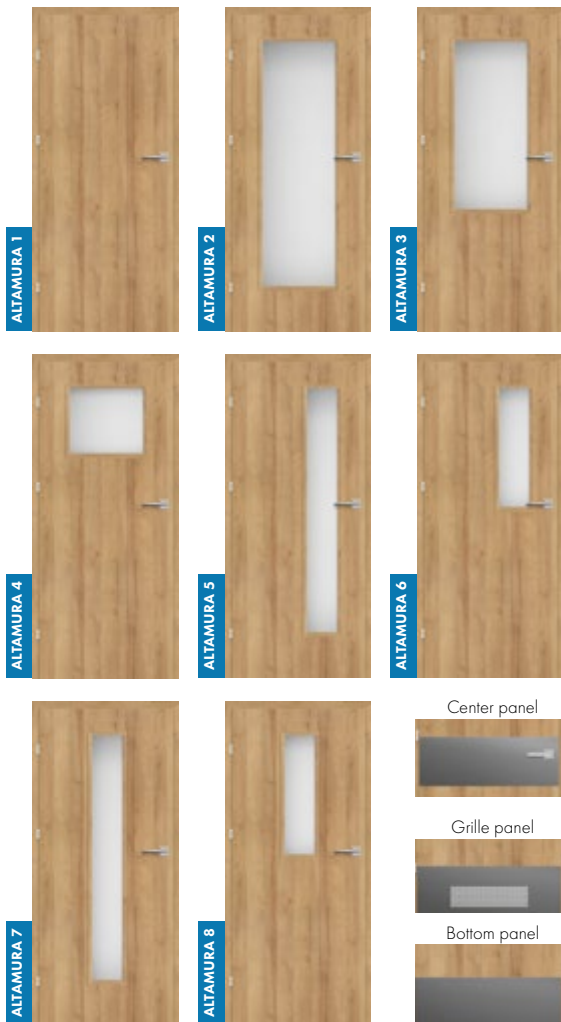

### PREMIUM

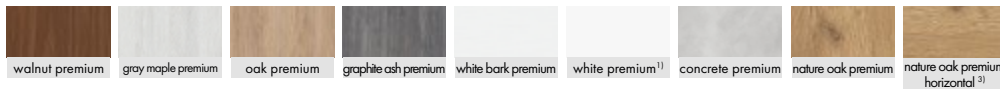

### GREKO

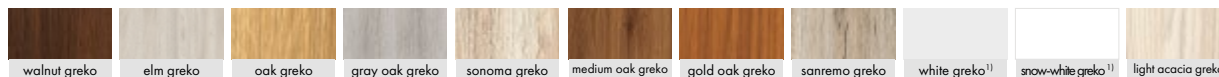

### CPL

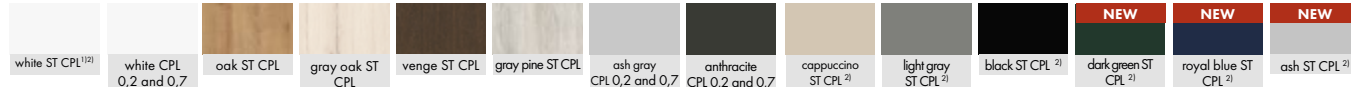

### EXTRA CHARGE

Reversible sash (not available in CPL 0.2 and 0.7).

Solid board filling.

Reinforcement for door closer.

Arm door closer (silver, black, white, brown).

Additional bottom beam (possibility of shortening on your own to max. 8 cm) standard PL and PL 2112.

Ventilation undercut, ventilation grille or recuperation shortcut.

Round or square metal sleeves (4 pcs.) brushed nickel, patina, white and black finish.

Black sash edge finish.

LUX inlays in the ALTAMURA 1 model; versions to choose from, pages 76-77.

Standard PL and PL 2112<sup>4)</sup>

Plastic sleeves.

Rebated and non-rebated "100" door sash.

VSG 221 frosted glass.

Drop down gasket.

Metal covers for hinges in the rebated door sash (brushed nickel, patina, glossy chrome, glossy brass, white and black).

In the ALTAMURA 1 model, a stainless steel porthole is available: polished chrome or brushed satin; frosted decormat glass, colourless glass, diam. porthole: ext. 235 mm ext. 350 mm).

Stainless steel panel (only STANDARD rebated sashes mounted on both sides), 300 mm high.

- lower Altawalla 1, 3, 4, 6, 8

- middle Altawalla 1, 4

- bottom with ventilation Altawalla 1, 3, 4, 6, 8

Replacement with a black magnetic lock for non-rebated and reversible sashes

<sup>1)</sup> Smooth white veneer imitating painted surface. <sup>2)</sup> A special AntiFinger **NEW** coating that reduces dirt and fingerprints <sup>3)</sup> The door frame is available in the OAK NatureE PREMIUM decor. <sup>4)</sup> The PL2112 standard is available in the PREMIUM, ST CPL and CPL0.2 decors and applies only to the rebated, non-rebated and non-rebated sash for the SP1N and SP2N wall systems

# LORIENT

INTERIOR WINDOWS, DOOR OPEN, DOOR OPEN AND REVERSIBLE DOOR SASHES



LORIENT 1, PREMIUM GRAY MAPLE decor, TOPAZ INOX door handle

## SOLUTIONS AVAILABLE

**PL**

PL Standard

**CZ**

CZ Standard

**PL2112**

PL2112 Standard

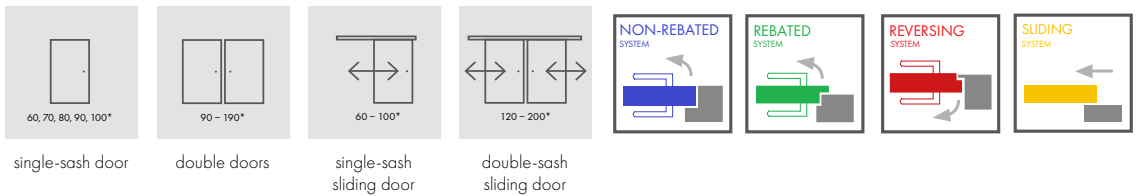

AVAILABLE **DOOR SASH WIDTHS**

60 70 80 90 100

GLAZING **FRAME**

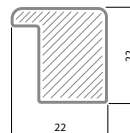

TYPES OF **EDGE FINISHING**



Smooth black sash edge finish



Black transverse finish of the door sash edge

Non-rebated



Standard



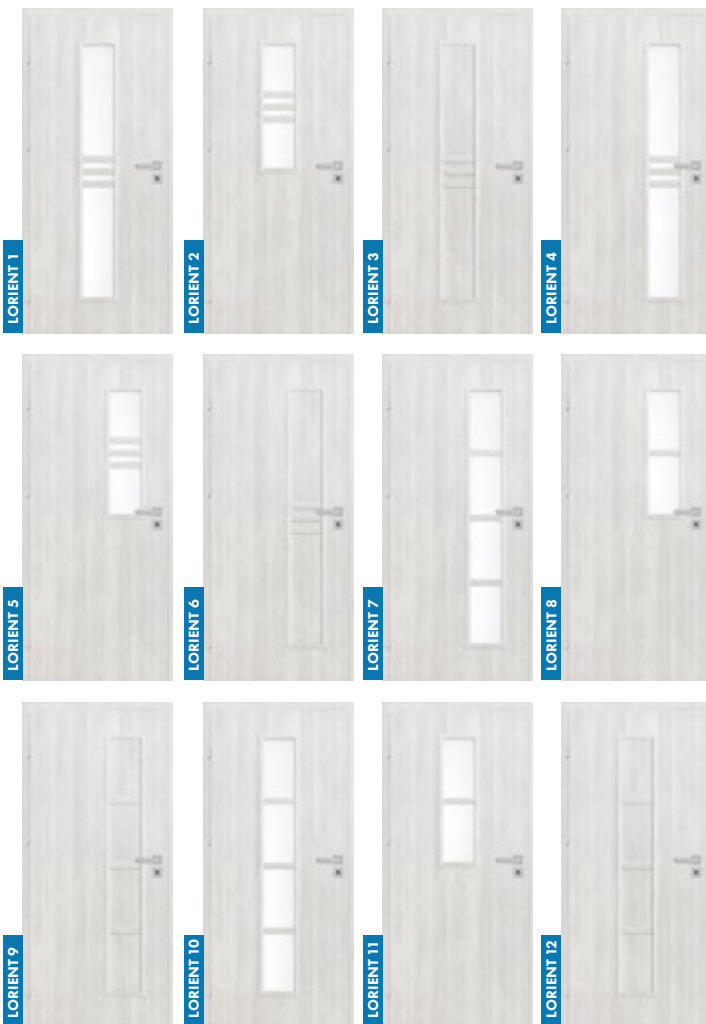

## CONSTRUCTION

- Rebated, non-rebated or reversible door sash.
- MDF rail and stile set covered with two HDF boards in GREKO decors.
- Internal wooden rail and stile set (sides, MDF top and bottom) covered with two HDF boards in CPL and PREMIUM decors.
- "Honeycomb" stabilizing filling or, at an extra charge, full plate filling.

## FINISH

- HDF board covered with veneer.
- The sash edge is made in STANDARD technology (FINISH, GREKO, PREMIUM and CPL).
- CPL 0.2 and 0.7 laminates available only in the STANDARD edge, which is covered with ABS edging only in the colour of the door sash or with a standard black edging at an additional cost.
- The reversible door sash is available only in the STANDARD edge and in the GREKO, PREMIUM and ST CPL decors.
- Edge (standard or non-rebated finish) covered with a border in the colour of the surface or optionally in smooth black (in the Nature OAK TRANSVERSE PREMIUM decor, a black border with a transverse structure)

## HARDWARE

- Three pin hinges screwed into the rebated door sash.
- Three hinges hidden in the non-rebated door sash and two hinges in the reversible door sash in silver (optionally in black for an extra charge); hinges are delivered with the door frame
- A lever tumbler lock in the rebated door sash and a magnetic lock in the non-rebated door sash and reversible door sash with a key, cylinder lock, saving lock or with a silver blockade; optional black magnetic lock for an extra charge.

## GLAZING

- Decormat glass as standard - frosted, transparent or at an extra charge VSG 221 frosted safe, smooth on both sides.
- Possibility of changing the glazing side to REVERSE (OBSERVE standard glazing).

### PREMIUM

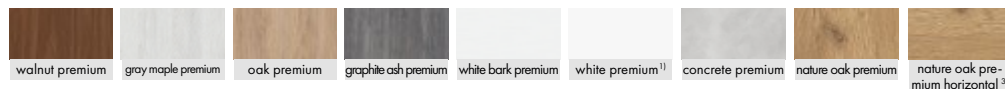

### GREKO

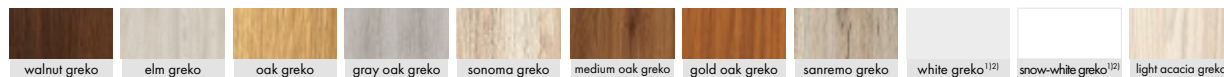

### CPL



### EXTRA CHARGE

- Reversible sash.
- Full board filling.
- Reinforcement for door closer.
- Arm door closer (silver, black, white, brown).
- Additional bottom beam (can be shortened on your own to a maximum of 8 cm) standard PL and PL 2112.
- Ventilation undercut, ventilation grille or recuperation shortcut.
- Round or square metal sleeves (4 pcs.) brushed nickel finish, patina, white and black.
- Black sash edge finish

- Plastic sleeves.
- Rebated and non-rebated "100" door sash.
- Laminated glass VSG 221 frosted glass; models: LORIENT 1, 2, 4, 5, 7, 8, 10, 11.
- Drop down gasket.
- Metal covers for hinges in the rebated door sash (brushed nickel, patina, glossy chrome, glossy brass, white and black).
- Replaced with a black magnetic lock for non-rebated and reversible sashes.
- PL2112 standard <sup>4)</sup>

<sup>1)</sup> Smooth white veneer imitating painted surface. <sup>2)</sup> A special Antifinger **NEW** coating that reduces dirt and fingerprints <sup>3)</sup> The door frame is available in the OAK NatureE PREMIUM decor. <sup>4)</sup> The PL2112 standard is available in the PREMIUM, ST CPL and CPL0.2 decors and applies only to the rebated, non-rebated and non-rebated sash for the SP1N and SP2N wall systems

# SORANO

INTERIOR WINDOWS, DOOR OPEN, DOOR OPEN AND REVERSIBLE DOOR SASHES



SORANO 1, WENGE ST CPL decor, TOPAZ INOX door handle

## SOLUTIONS AVAILABLE

**PL**

PL Standard

**CZ**

CZ Standard

**PL2112**

PL2112 Standard

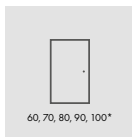

single-sash door

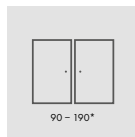

double doors

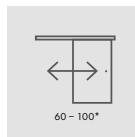

single-sash sliding door

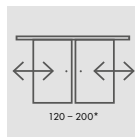

double-sash sliding door

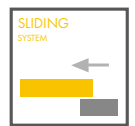
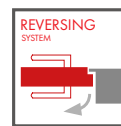
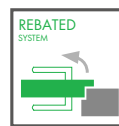
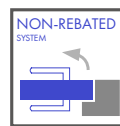

### AVAILABLE DOOR SASH WIDTHS

60

70

80

90

100

### GLAZING FRAME

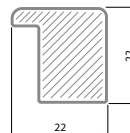

### TYPES OF EDGE FINISHING



Smooth black sash edge finish



Black transverse finish of the door sash edge

Non-rebated



Standard



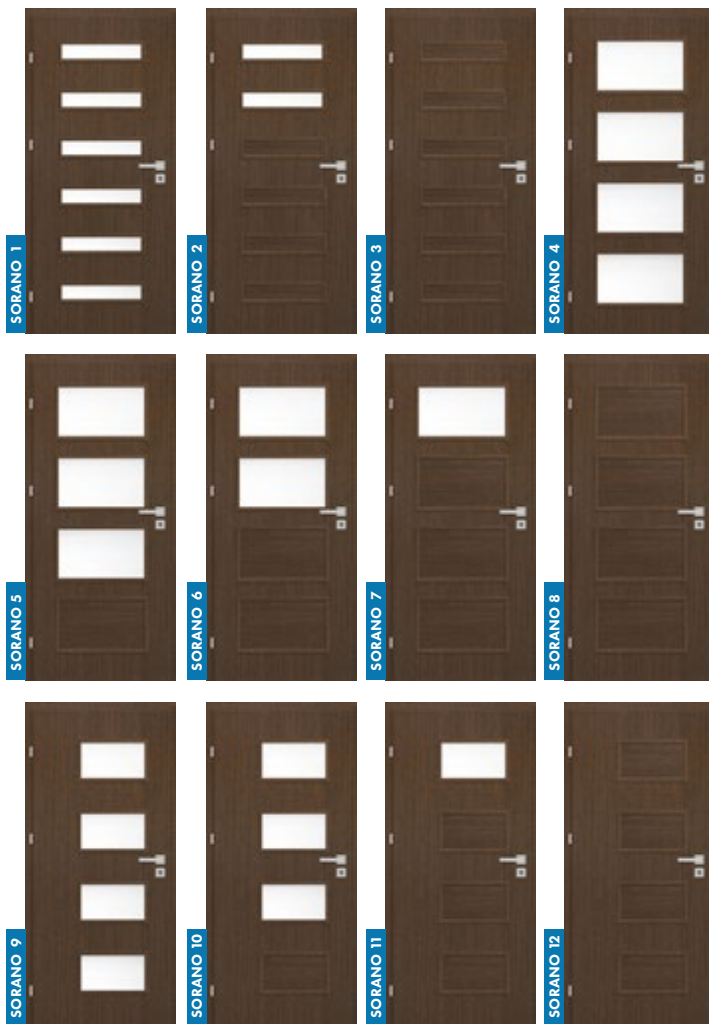

## CONSTRUCTION

- Rebated, non-rebated or reversible door sash.
- MDF rail and stile set covered with two HDF boards in GREKO decors.
- Internal wooden rail and stile set (sides, MDF top and bottom) covered with two HDF boards in CPL and PREMIUM decors.
- "Honeycomb" stabilizing filling or, at an extra charge, full plate filling.

## FINISH

- HDF board covered with veneer.
- The sash edge is made in STANDARD technology (FINISH, GREKO, PREMIUM and CPL).
- CPL 0.2 and 0.7 laminates available only in the STANDARD edge, which is covered with ABS edging only in the colour of the door sash or with a standard black edging at an additional cost.
- The reversible door sash is available only in the STANDARD edge and in the GREKO, PREMIUM and ST CPL decors.
- Edge (standard or non-rebated finish) covered with a border in the colour of the surface or optionally in smooth black (in the Nature OAK TRANSVERSE PREMIUM decor, a black border with a transverse structure)

## HARDWARE

- Three pin hinges screwed into the rebated door sash.
- Three hinges hidden in the non-rebated door sash and two hinges in the reversible door sash in silver (optionally in black for an extra charge); hinges are delivered with the door frame
- A lever tumbler lock in the rebated door sash and a magnetic lock in the non-rebated door sash and reversible door sash with a key, cylinder lock, saving lock or with a silver blockade; optional black magnetic lock for an extra charge.

## GLAZING

- Decormat glass as standard - frosted, transparent or at an extra charge VSG 221 frosted safe, smooth on both sides.
- Possibility of changing the glazing side to REVERSE (OBSERVE standard glazing).

### PREMIUM



### GREKO

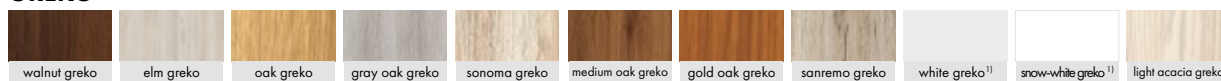

### CPL



### EXTRA CHARGE

Reversible sash.

Full board filling.

Reinforcement for door closer.

Arm door closer (silver, black, white, brown).

Additional bottom beam (can be shortened on your own to a maximum of 8 cm) standard PL and PL 2112.

Ventilation undercut, ventilation grille or recuperation shortcut.

Round or square metal sleeves (4 pcs.) brushed nickel finish, patina, white and black.

Black sash edge finish

Plastic sleeves.

Rebated and non-rebated "100" door sash.

Laminated glass VSG 221 frosted glass.

Drop down gasket.

Metal covers for hinges in the rebated door sash (brushed nickel, patina, glossy chrome, glossy brass, white and black).

Replaced with a black magnetic lock for non-rebated and reversible sashes.

PL2112 standard 4)

<sup>1)</sup> Smooth white veneer imitating painted surface. <sup>2)</sup> A special Antifinger **NEW** coating that reduces dirt and fingerprints <sup>3)</sup> The door frame is available in the OAK NatureE PREMIUM decor. <sup>4)</sup> The PL2112 standard is available in the PREMIUM, ST CPL and CPL0.2 decors and applies only to the rebated, non-rebated and non-rebated sash for the SP1N and SP2N wall systems

# ANSEDONIA

INTERIOR WINDOWS, DOOR OPEN, DOOR OPEN AND REVERSIBLE DOOR SASHES



ANSEDONIA 1, Gray OAK ST CPL decor, TOPAZ INOX door handle

## SOLUTIONS AVAILABLE

**PL**

PL Standard

**CZ**

CZ Standard

**PL2112**

PL2112 Standard

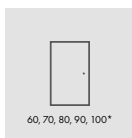

single-sash door

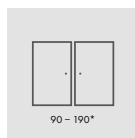

double doors

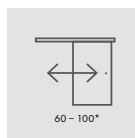

single-sash sliding door

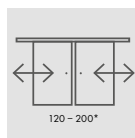

double-sash sliding door

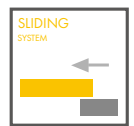
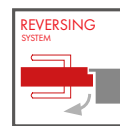
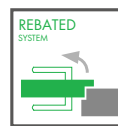
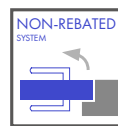

### AVAILABLE DOOR SASH WIDTHS

60

70

80

90

100

### TYPES OF EDGE FINISHING



Smooth black sash edge finish



Black transverse finish of the door sash edge

### GLAZING FRAME

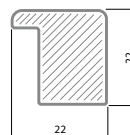

Non-rebated



Standard





## CONSTRUCTION

- Rebated, non-rebated or reversible door sash.
- MDF rail and stile set covered with two HDF boards in GREKO decors.
- Internal wooden rail and stile set (sides, MDF top and bottom) covered with two HDF boards in CPL and PREMIUM decors.
- "Honeycomb" stabilizing filling or, at an extra charge, full plate filling.

## FINISH

- HDF board covered with veneer.
- The sash edge is made in STANDARD technology (FINISH, GREKO, PREMIUM and CPL).
- CPL 0.2 and 0.7 laminates available only in the STANDARD edge, which is covered with ABS edging only in the colour of the door sash or with a standard black edging at an additional cost.
- The reversible door sash is available only in the STANDARD edge and in the GREKO, PREMIUM and ST CPL decors.
- Edge (standard or non-rebated finish) covered with a border in the colour of the surface or optionally in smooth black (in the Nature OAK TRANSVERSE PREMIUM decor, a black border with a transverse structure)

## HARDWARE

- Three pin hinges screwed into the rebated door sash.
- Three hinges hidden in the non-rebated door sash and two hinges in the reversible door sash in silver (optionally in black for an extra charge); hinges are delivered with the door frame
- A lever tumbler lock in the rebated door sash and a magnetic lock in the non-rebated door sash and reversible door sash with a key, cylinder lock, saving lock or with a silver blockade; optional black magnetic lock for an extra charge.

## GLAZING

- Decormat glass as standard - frosted, transparent or at an extra charge VSG 221 frosted safe, smooth on both sides.
- Possibility of changing the glazing side to REVERSE (OBSERVE standard glazing).

### PREMIUM

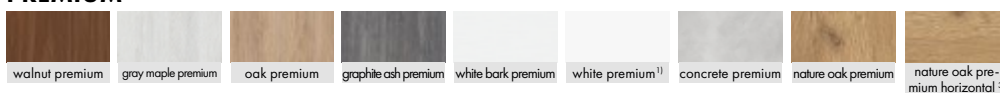

### GREKO

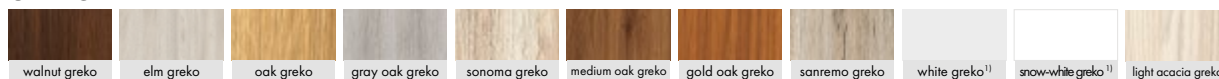

### CPL

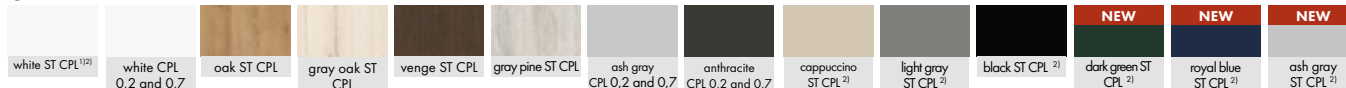

### EXTRA CHARGE

Reversible sash.

Full board filling.

Reinforcement for door closer.

Arm door closer (silver, black, white, brown).

Additional bottom beam (can be shortened on your own to a maximum of 8 cm) standard PL and PL 2112.

Ventilation undercut, ventilation grille or recuperation shortcut.

Round or square metal sleeves (4 pcs.) brushed nickel finish, patina, white and black.

Black sash edge finish

Plastic sleeves.

Rebated and non-rebated "100" door sash.

Laminated glass VSG 221 frosted glass.

Drop down gasket.

Metal covers for hinges in the rebated door sash (brushed nickel, patina, glossy chrome, glossy brass, white and black).

Replaced with a black magnetic lock for non-rebated and reversible sashes.

PL2112 standard <sup>4)</sup>

<sup>1)</sup> Smooth white veneer imitating painted surface. <sup>2)</sup> A special Antifinger **NEW** coating that reduces dirt and fingerprints <sup>3)</sup> The door frame is available in the OAK NatureE PREMIUM decor. <sup>4)</sup> The PL2112 standard is available in the PREMIUM, ST CPL and CPL0.2 decors and applies only to the rebated, non-rebated and non-rebated sash for the SP1N and SP2N wall systems

# MENTON

INTERIOR WINDOWS, DOOR OPEN, DOOR OPEN AND REVERSIBLE DOOR SASHES



MENTON 1, Gray OAK ST CPL decor, TOPAZ INOX door handle

## SOLUTIONS AVAILABLE

**PL**

PL Standard

**CZ**

CZ Standard

**PL2112**

PL2112 Standard

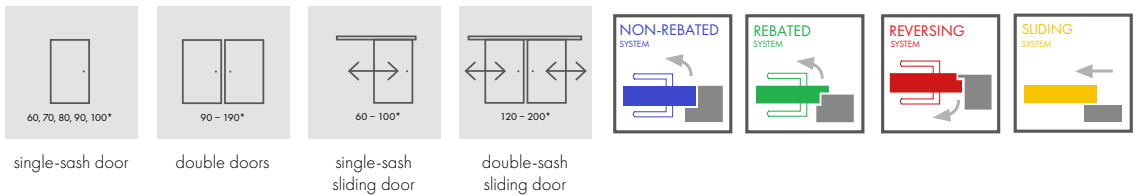

AVAILABLE **DOOR SASH WIDTHS**

60 70 80 90 100

TYPES OF **EDGE FINISHING**



GLAZING **FRAME**

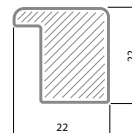

Non-rebated

Standard

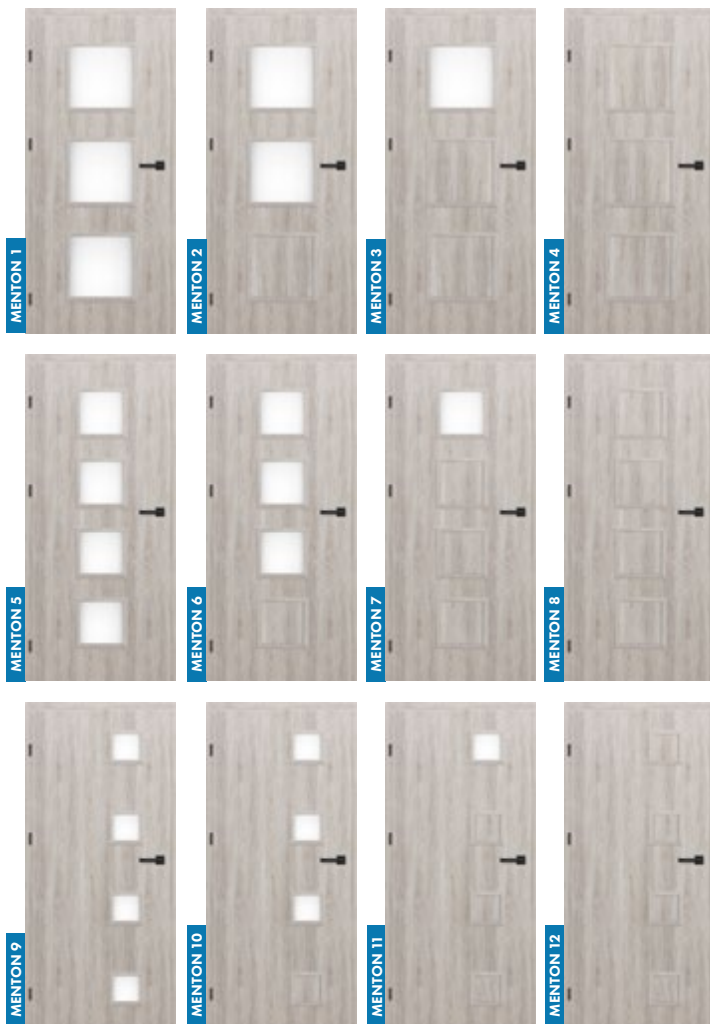

## CONSTRUCTION

- Rebated, non-rebated or reversible door sash.
- MDF rail and stile set covered with two HDF boards in GREKO decors.
- Internal wooden rail and stile set (sides, MDF top and bottom) covered with two HDF boards in CPL and PREMIUM decors.
- "Honeycomb" stabilizing filling or, at an extra charge, full plate filling.

## FINISH

- HDF board covered with veneer.
- The sash edge is made in STANDARD technology (FINISH, GREKO, PREMIUM and CPL).
- CPL 0.2 and 0.7 laminates available only in the STANDARD edge, which is covered with ABS edging only in the colour of the door sash or with a standard black edging at an additional cost.
- The reversible door sash is available only in the STANDARD edge and in the GREKO, PREMIUM and ST CPL decors.
- Edge (standard or non-rebated finish) covered with a border in the colour of the surface or optionally in smooth black (in the Nature OAK TRANSVERSE PREMIUM decor, a black border with a transverse structure)

## HARDWARE

- Three pin hinges screwed into the rebated door sash.
- Three hinges hidden in the non-rebated door sash and two hinges in the reversible door sash in silver (optionally in black for an extra charge); hinges are delivered with the door frame
- A lever tumbler lock in the rebated door sash and a magnetic lock in the non-rebated door sash and reversible door sash with a key, cylinder lock, saving lock or with a silver blockade; optional black magnetic lock for an extra charge.

## GLAZING

- Decormat glass as standard - frosted, transparent or at an extra charge VSG 221 frosted safe, smooth on both sides.
- Possibility of changing the glazing side to REVERSE (OBSERVE standard glazing).

### PREMIUM

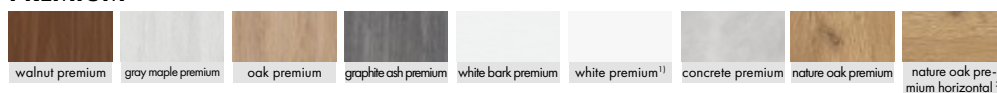

### GREKO

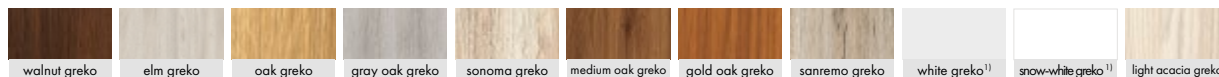

### CPL



### EXTRA CHARGE

Reversible sash (not available in CPL 0,2 and 0,7).

Full board filling.

Reinforcement for door closer.

Arm door closer (silver, black, white, brown).

Additional bottom beam (can be shortened on your own to a maximum of 8 cm) standard PL and PL 2112.

Ventilation undercut, ventilation grille or recuperation shortcut.

Round or square metal sleeves (4 pcs.) brushed nickel finish, patina, white and black.

Black sash edge finish

Plastic sleeves.

Rebated and non-rebated "100" door sash.

Laminated glass VSG 221 frosted glass.

Drop down gasket.

Metal covers for hinges in the rebated door sash (brushed nickel, patina, glossy chrome, glossy brass, white and black).

Replaced with a black magnetic lock for non-rebated and reversible sashes.

PL2112 standard <sup>4)</sup>

<sup>1)</sup> Smooth white veneer imitating painted surface. <sup>2)</sup> A special AntiFinger **NEW** coating that reduces dirt and fingerprints <sup>3)</sup> The door frame is available in the OAK NatureE PREMIUM decor. <sup>4)</sup> The PL2112 standard is available in the PREMIUM, ST CPL and CPL0.2 decors and applies only to the rebated, non-rebated and non-rebated sash for the SP1N and SP2N wall systems

# GLASS DOOR



## PATTERNS

- Interesting design, 30 models to choose from.

## COLOUR

- A wide range of frame colours, up to 34 decors.

## GLAZING

- 8 mm tempered glass or laminated and tempered VSG/ESG glass.

## VENTILATION

- Possibility of making a ventilation undercut.

## DOOR FRAMES

- You can choose from a fixed or adjustable door frame with a 6 cm or 8 cm band.



## AVAILABLE SYSTEMS

### GLASS DOOR SYSTEM

- modern design
- 2 hinges
- handles and hinges: stainless steel, black, white



=



+



+





# GLASS DOOR GRAF

INTERIOR GLASS DOOR SASHES



GRAF 1



GRAF 6



GRAF 8



GRAF 9



GRAF 11



GRAF 17



GRAF 22



GRAF 26

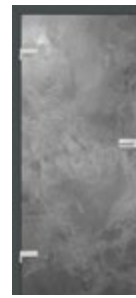

GRAF 27



GRAF 29



GRAF 30



GRAF 32



GRAF 33

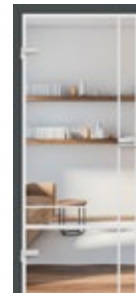

GRAF 34



GRAF 35



GRAF 36



GRAF 37



GRAF 38



GRAF 39



GRAF 41

# GLASS DOOR GRAF

INTERIOR GLASS DOOR SASHES



GRAF 42



GRAF 43

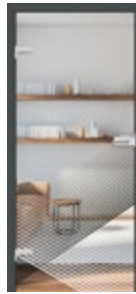

GRAF 53



GRAF 54



GRAF 59



GRAF 60



GRAF 61

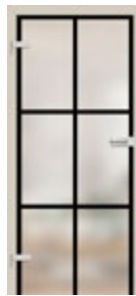

GRAF 62



GRAF 63



GRAF 64

# GLASS DOOR



## AVAILABLE DOOR SASH WIDTHS

60 70 80 90 (extra charge)

## CONSTRUCTION

- 8 mm tempered glass with or without external decorative patterns, 8 mm tinted glass (GRAF 26) or, for an extra charge, laminated and tempered VSG/ESG glass with black internal decorative patterns for GRAF 32, 33, 35, 36, 38, 39, 61, 62
- Possibility of changing the glazing side to REVERSE (OBSERVE standard glazing).
- Depending on the model design, frosted or colorless glass with patterns painted in black or white.
- Line width (thickness) in GRAF 35, 36, 38, 39, 61, 62 model is 30 mm.

## FIXED AND ADJUSTABLE FRAME

- Prices of adjustable and fixed frames for rebated doors.
- No possibility to use an electric strike.
- Door frames for glass panes use a hinge with a 10 mm pin.
- Only rebated door frames in all available decors are available for glass graf door sashes, door frame painted white titanium UV.

## EXTRA CHARGE

Ventilation undercut.

Door sash "90".

Black or white striker plate

VSG/ESG glass with black internal application (GRAF 32, 33, 35, 36, 38, 39, 61, 62)

## HARDWARE METAL-BUD

**Metal-Bud**

Available shapes: **oval** or **rectangle**



2A OVAL



3A OVAL



1A OVAL



4AZ OUTER OVAL  
4AW INNER OVAL



HINGE OVAL



2B RECTANGLE



3B RECTANGLE



1B RECTANGLE



4BZ OUTER RECTANGLE  
4BW INNER RECTANGLE



HINGE RECTANGLE



2B RECTANGLE



3B RECTANGLE



1B RECTANGLE



4BZ OUTER RECTANGLE  
4BW INNER RECTANGLE



HINGE RECTANGLE

<sup>2)</sup> With VSG/ESG glass, two glued glass panes are visible from the edge side.



# HERSE SET 30dB/32dB

HERSE SET AKUSTIC 39 dB

FRONT DOORS WITH BURGLAR-PROOF LOCKS OR STRIP LOCKS

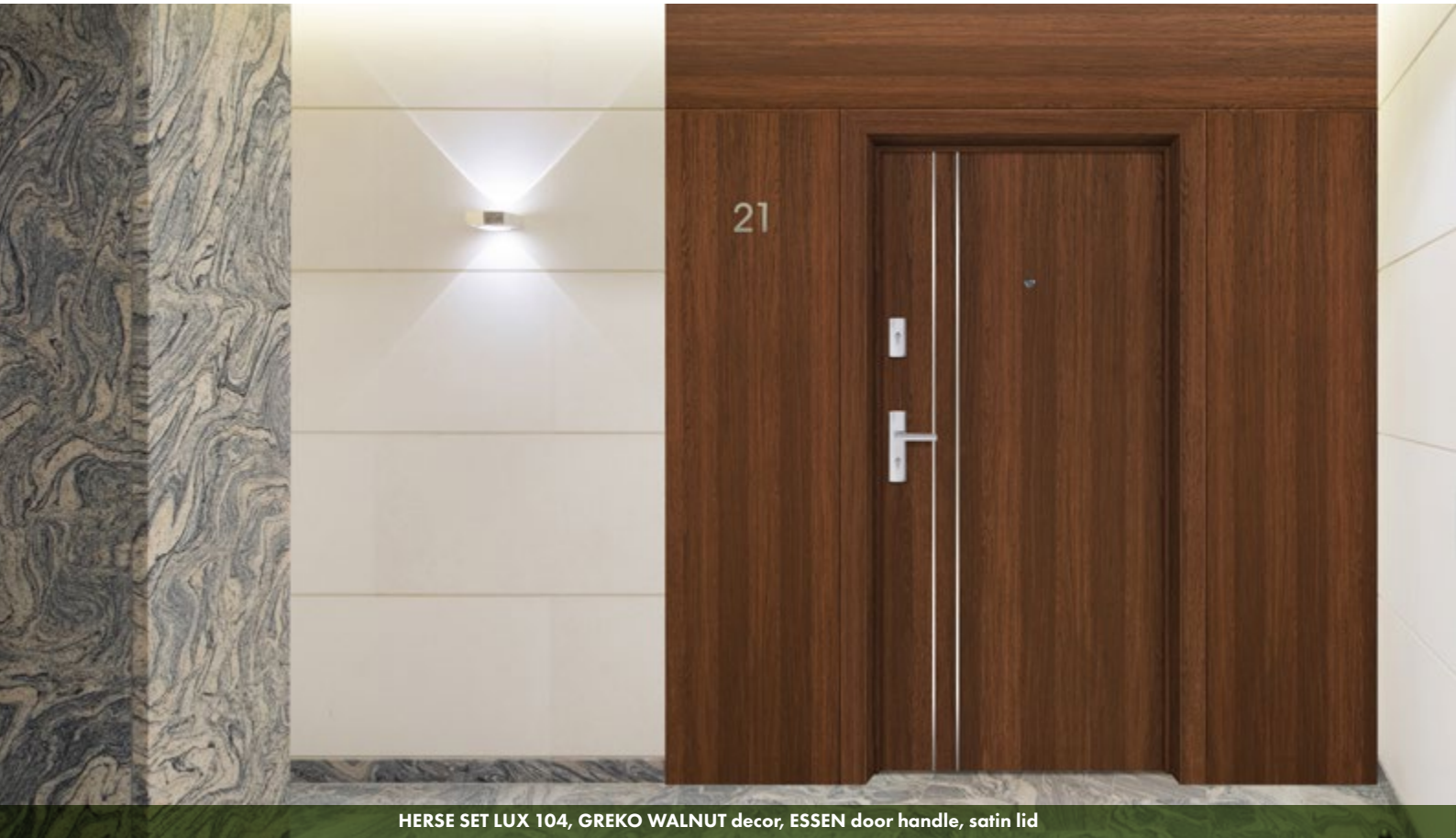

HERSE SET LUX 104, GREKO WALNUT decor, ESSEN door handle, satin lid

## SOLUTIONS AVAILABLE

PL

PL Standard

CZ

CZ Standard



upper security lock

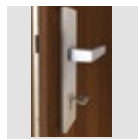

lower security lock

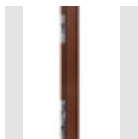

adjustable main keeper in frame



three 2-pin hinges; 3d adjustable

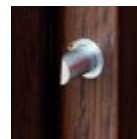

3 hinge bolts



hardwood threshold (lacquer)



essen handle



door viewer



drop down gasket with pressure adjustment



stainless steel threshold

Standard

- HERSE SET AKUSTIC 39 dB DOOR, thickness 46 mm, reinforced with channel section and sheet steel
- HERSE SET 32 dB DOOR, thickness 46 mm, reinforced with steel channel section
- HERSE SET EKO 30 dB DOOR, thickness 46 mm, reinforced with steel channel section

AVAILABLE DOOR SASH WIDTHS

80

90E

100



## GENERAL INFORMATION

- HERSE SET doors are designed for utility construction public and residential as internal entrance doors.
- The HERSE SET door sash with a fixed and adjustable frame and with each available threshold has acoustic insulation at the level of  $R_w = 30\text{dB}/R_{W'} = 32\text{dB}$  or  $R_w = 39\text{dB}$  for an extra charge

## CONSTRUCTION

- Timber frame for  $R_w = 32\text{dB}$  and  $R_w = 39\text{dB}$  or MDF for  $R_w = 30\text{dB}$  covered with two HDF boards.
- Filling with a special solid board.
- Reinforcement with a massive steel channel section  $R_w = 30\text{dB}$  and  $R_w = 32\text{dB}$  and additionally a steel plate for  $R_w = 39\text{dB}$ .
- Door sash thickness 46 mm.
- Additional gasket in the sash only for  $R_w = 32\text{dB}$  and  $R_w = 39\text{dB}$ .

## FINISH

- Sash edge made in STANDARD technology.
- CPL 0.2 and 0.7 laminatees available in edge only STANDARD, which is covered with ABS edging only in the colour of the door sash or with a standard black edging for an extra charge.
- Inserts (inlays) colour: brushed steel, black, brushed gold, 8 mm wide, flush with the sash plane, on both sides of the sash.
- STANDARD edge covered with an edging in the colour of the door sash or optionally in smooth black (in the HORIZONTAL Nature OAK PREMIUM decor, a black edging with a transverse structure).
- Custom order with the lower lock only as an option.

## HARDWARE

- Three silver 2-pin  $\varnothing 16$  hinges with 3D adjustment (2D with a steel frame).
- Two three-bolt anti-burglary class 2 locks for a cylinder (optional selection of only the bottom lock included in the price).
- Three anti-theft bolts on the hinge side.
- Possibility of using an arm door closer.
- Lower lock PZ centre is 72mm.
- Optionally, a strip lock for two pin inserts is available at an extra charge.

## FIXED AND ADJUSTABLE REBATED FRAME

- Possibility of using the electric strike in door frames only for the lower lock, which excludes the use of the upper lock in the sash.
- Adjustable main catch in the door frame.
- Fixed wooden door frame for  $R_w = 32\text{dB}$  and  $R_w = 39\text{dB}$  or MDF door frame for  $R_w = 30\text{dB}$ .

SECTION OF HERSE SASH 32 DB

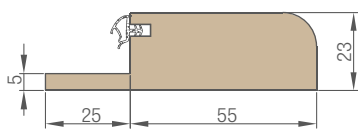
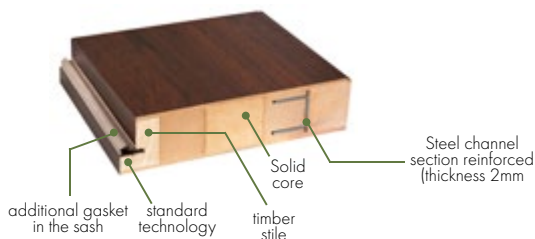

Hardwood threshold

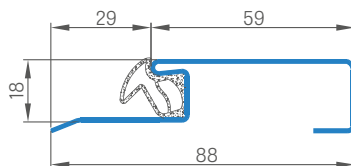

Threshold made of stainless steel



HERSE SET, OAK PREMIUM decor, ESSEN door handle

## GREKO

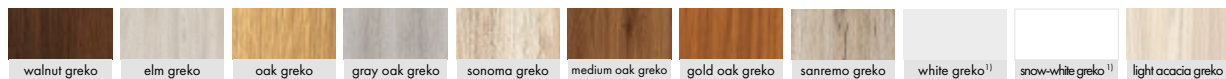

## PREMIUM

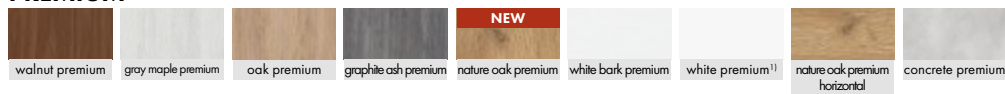

## CPL



## EXTRA CHARGE

Silver or black door viewer

Hardwood threshold (clear varnish) with a 55 mm wide gasket or stainless steel threshold with a gasket.

Arm door closer (silver, black, white, brown).

Reinforcement for door closer.

Drop down gasket.

Metal hinge covers: brushed nickel, patina, glossy chrome, glossy brass, white and black;

CZ standard product.

LUX inlays.

Black sash edge finish.

Door sash "100".

30/45 lock core silver or black.

30G/45 or 30/45G cylinder-holder, silver or black.

30/45 lock core and 30G/45 or 30/45G cylinder-holder in the master key system silver or black.

ESSEN handle (satin nickel, patina, black).

ESSEN upper plate (satin nickel, patina, black).

Additional charge for HERSE SET AKUSTIC 39 dB door

Multi-point bolt strip lock with two locks.

<sup>1)</sup> Smooth white veneer imitating painted surface.

<sup>2)</sup> Special **AntiFinger** **NEW** coating to reduce dirt and fingerprints.

<sup>3)</sup> STANDARD only available.



# FIXED AND ADJUSTABLE DOOR FRAME

HERSE SET, HERSE MAX SET

Scheme of the fixed door frame

HERSE SET

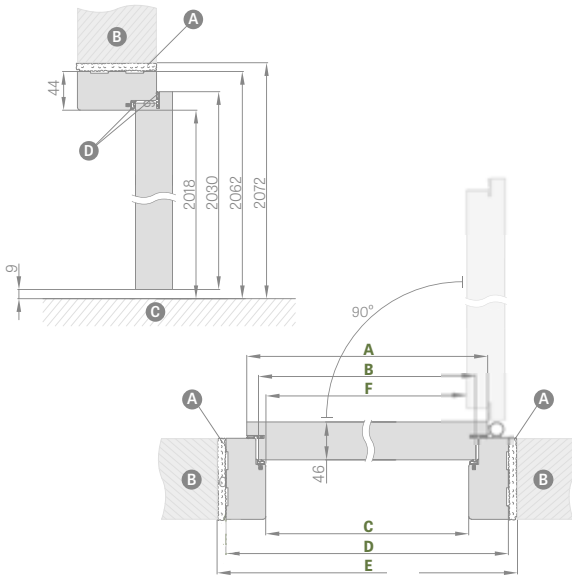

Scheme of the adjustable door frame

HERSE SET

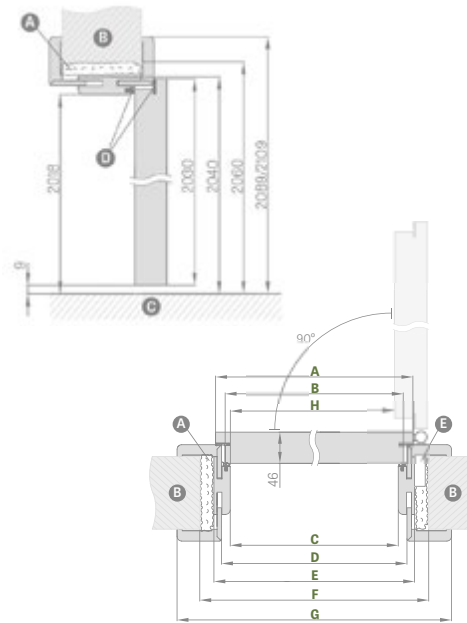

Adjustment range  
min - max (mm)

80-100
100-120
120-140
140-160
160-180
180-200
200-220
220-240
240-260
260-280
280-320
320-340
340-360
360-380
380-400
400-420

1 element  
2 elements  
3 elements

Door width	A	B	C	D	E	F
"80"	844	817	804	892	912	796
"90E"	948	921	908	996	1016	900
"100"	1044	1017	1004	1092	1112	996

Door width	A	B	C	D	E	F	G	H
"80"	844	817	804	826	848	888	946* / 986**	796
"90E"	948	921	908	930	952	992	1050* / 1090**	900
"100"	1044	1017	1004	1026	1048	1088	1146* / 1186**	996

\* architrave 6 cm / architrave 8 cm

"90E" - investment width

**A** mounting foam **B** wall **C** floor **D** rubber gasket

Adjustment range of the adjustable door frame

band 6/8 cm

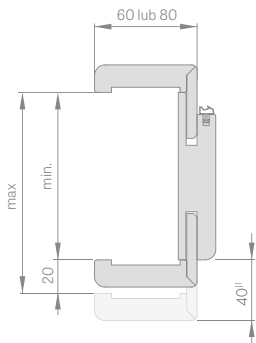

Adjustable wooden threshold

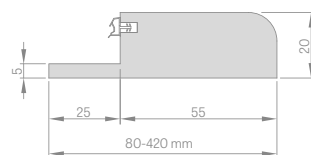

band 6 cm and 8 cm

with clips  
(includes 3 pcs.)

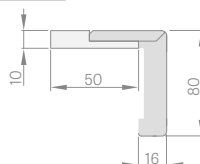

Fixed door frame

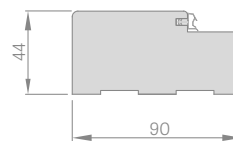

Masking band

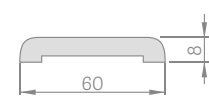

Quarter round

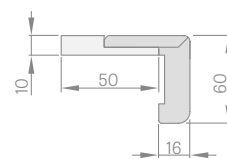
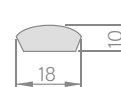

clip (includes 3 pcs.)

- Frames in CPL 0.2 are also used in the set for sashes in CPL 0.7.
- Joining the door frame adjustable at an angle of 90 degrees is possible only in the door frame with an 8 cm architrave.
- 90 degree connection surcharge.
- Electric strike.
- Reinforcement for the door closer to the adjustable door frame.

- Angle bar with three clips (An angle bar with clips increases the adjustment range by 20 mm).
- Band and quarter round.
- Shortening of the door with a wooden door frame in the CZ standard.

<sup>1)</sup> 40mm for the range 280-320mm



# LOCK CORE

## HOW TO SELECT A LOCK CORE?



Sample calculation of the cylinder size for board and rail doors (40mm) with the thickness of the escutcheon  $G = 7$  mm

$$A/B = (C+G+3) / (D+G+3)$$

$$A/B = (15+7+3) / (25+7+3)$$

$$A/B = 25/35$$

INSERT		INSERT WITH KNOB	
Size		Size	
rebated and reverse 26/36	- silver - black	herse set 30/45G	- silver - black
non-rebated 30/30	- silver - black	herse set 30G/45	- silver - black
Herse set 30/45	- silver - black		

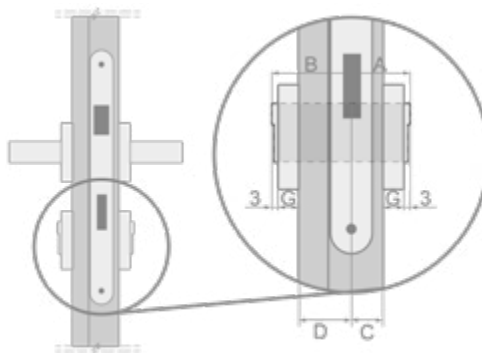

Lock cores in the master key system 30/45 + 30G/45  
Outswing doors – silver, black

Lock cores in the master key system 30/45 + 30/45G  
Inswing doors – silver, black

Door type	Door sash thickness	Proportion of lock setting in door (C/D)	Recommended lock core size (A/B)*
Flush, panelled (rebated)	40 mm	15/25	26/36
Flush, stile (non-rebated)	40 mm	20/20	30/30
HERSE	46 mm	15/31	30/45

# TECHNICAL INFORMATION

## DOOR OPENING DIRECTIONS

SINGLE DOORS  
LEFT DOOR SASH

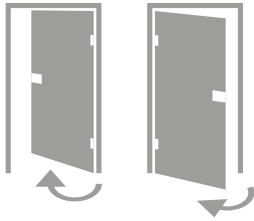

SINGLE DOORS  
RIGHT DOOR SASH

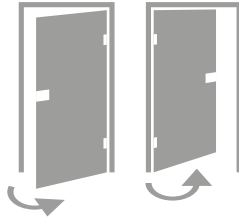

REBATED, NON-REBATED, REVERSE DOORS

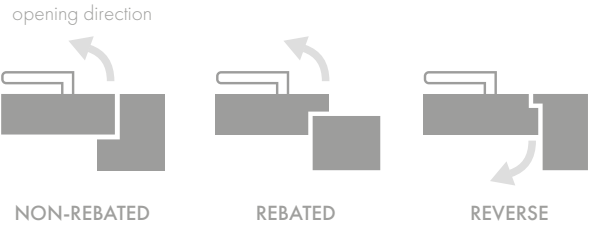

## DOUBLE DOORS

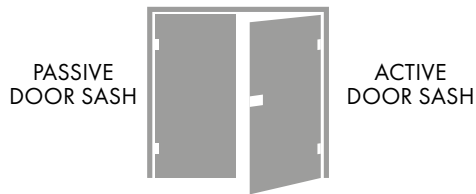

## DOOR FRAME JOINTS



## HOW TO CALCULATE DOOR PRICE?

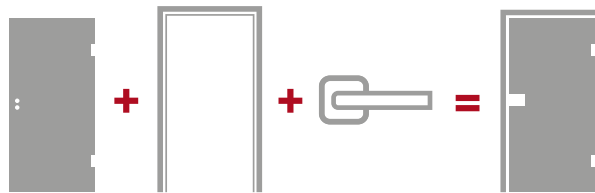

## SOLUTIONS AVAILABLE

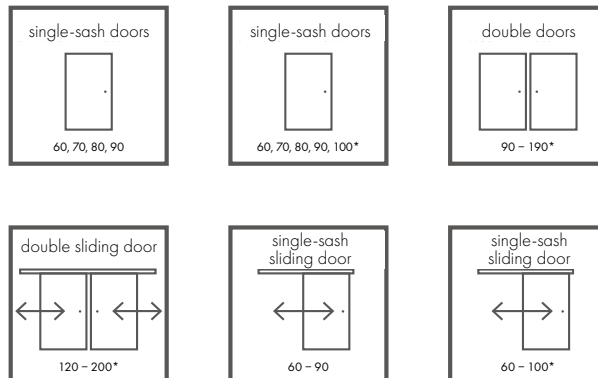

# TYPES OF DOOR SURFACE FINISHES

## GREKO

The GREKO laminate is also pre-impregnated, which means printing and then coating with paint with required properties. Using the performance finishing coats adds to the surface's resistance and flexibility of the product. The paint's silicon content ensures the film resistance is enhanced.

The GREKO laminate is manufactured on a high density Japanese base layer which is not resin coated. This makes the film ecological, healthy and safe for people and environment both in the production process and during use, as well as for disposal. No formaldehyde or other harmful ingredients is used. Its distinctive patterns are what distinguishes the GREKO film.

The decors bear striking resemblance to wood, as the high quality surface comes with a 3D natural wood effect. The facings look just like wood.

## PREMIUM

The PREMIUM facing is a product based on Polypropylene (PP), a material of very high resistance to abrasion and scratching, plus top quality appearance. It adds a refined look and individual character to the doors, as it imitates natural wood perfectly.

Not only does the PREMIUM facing attract with its appearance but with its functionality, as it resists scratching better than average products and is fire-retardant and abrasion resistant.

These properties ensure the extended longevity and maintenance-free use of the PREMIUM range products even in most adverse conditions.

## ST CPL, CPL 0,2 AND CPL 0,7

The CPL facing is composed of a decorative layer impregnated in resins, and a base layer ensuring flexibility. Following the lamination process, the top resin layer is hardened for high resistance to scratching and abrasion. It is characterised by high resistance to impact, abrasion, scratching, heat and UV radiation.

Thanks to using this type of material, the door can be installed in so-called "difficult" interiors [exposed to heat, moisture or extraordinary use]. Approx. laminate thickness: ST CPL - 0.15 mm, CPL 0.2 - 0.2 mm and CPL 0.7 - 0.7 mm. The CPL 0.7 laminate is used to cover only one sash plane thanks to its unique hardness. The CPL 0.2 and CPL 0.7 laminated door sashes come with the sash edge made of the so-called ABS, a highly durable PVC.

ST CPL facing in white, light gray, cappuccino, black has been refined in the AntiFinger coating limiting dirt and fingerprints.

## UV VARNISH

The door surface has several coats of the WHITE TITANIUM UV modern UV hardened varnish.

The flat surfaces are covered with a specialist base membrane in the first phase, and then coated twice with a top quality paint and hardened with UV.

The moulded surfaces cannot be covered with the membrane for technological reasons, so they are coated with three paint layers and hardened with UV.

The fully automatic coating process follows scanning to ensure ideal quality of the surface. Hardening the paint with the cutting-edge method involving UV light source ensures very high mechanical resistance.

## TYPES OF EDGE FINISHES

### SOFT EDGE



The SOFT door sash comes with a chamfered edges, which lends an aesthetic and modern look to it. The sash is finished with a facing layer of an improved resistance to scratching, which dramatically enhances its resistance during use.



### STANDARD EDGE



It involves covering the flat plane with the 0.15 mm ST CPL, CPL 0.2, CPL 0.7 facings, polypropylene PREMIUM facing or GREKO laminate. The door sash made in STANDARD technology has unchamfered edges, which is where the face panel is joined with edges facing, as shown in the diagram. The facing layer in the CPL 0.2 and CPL 0.7 laminates is made of very durable PVC, the so-called ABS. The joining method of the facing is also identical for the non-rebated doors and non-rebated sliding systems.



1) applies only to BALDUR 1 in WHITE ST CPL facing with solid core filling

# SASH DIMENSIONS IN THE POLISH STANDARD PL

## STILE DOOR

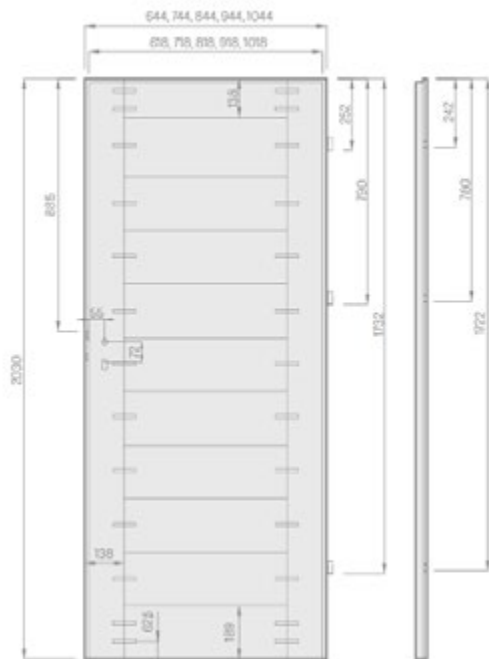

Rebated door sash

## PLATE DOOR

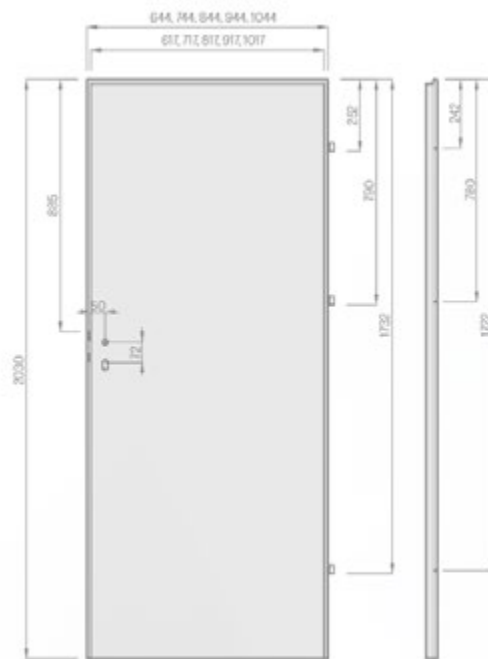

Rebated door sash

# SASH DIMENSIONS CZECH STANDARD CZ

## STILE DOOR

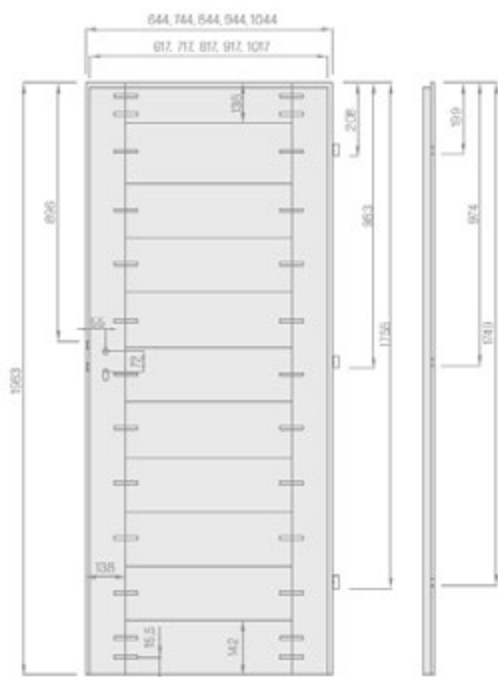

Rebated door sash

## PLATE DOOR

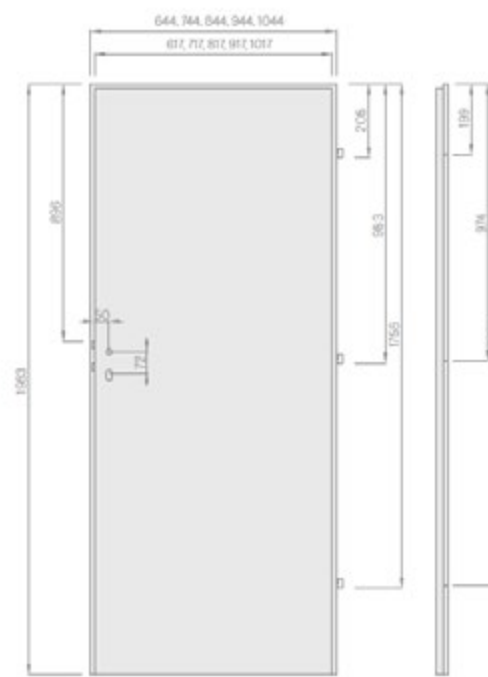

Rebated door sash

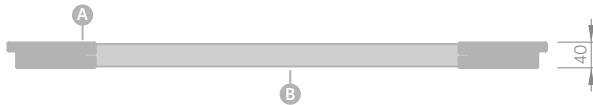

- A MDF stiles
- B MDF dwarsliggers



Stable crossbar 35 mm or 22 mm thick



Aesthetic frameless inset glazing



- A MDF stiles
- B gasket
- C HDF frame
- D filling
- E MDF or wooden frames in Herse SET en UNO PREMIUM



MDF stile and stile set for GREKO, PREMIUM and CPL veneers, also with AntiFinger coating



Honeycomb filling



Solid core filling

## GRAF GLASS SHEET

### DIMENSION PL STANDARD

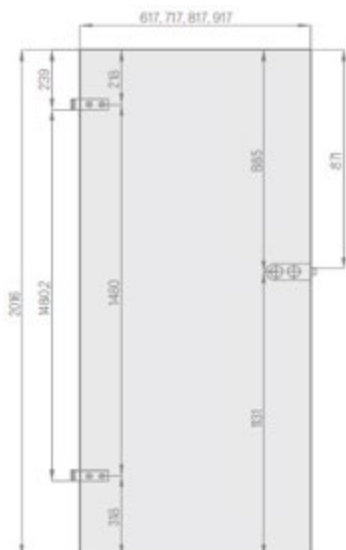

### DIMENSION CZ STANDARD

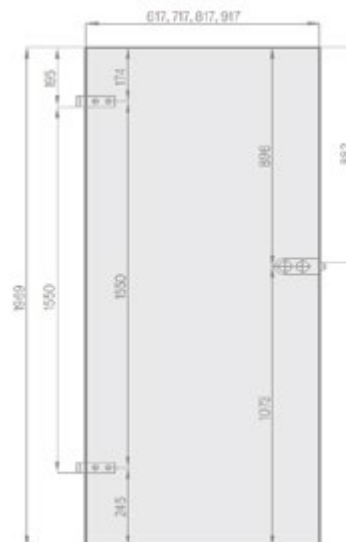

## SIDE BATHROOM LOCK

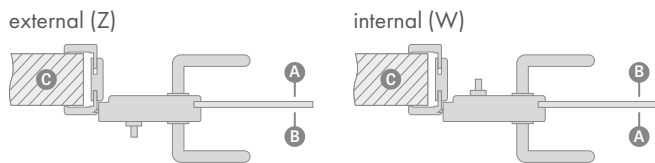

**A** Hall    **B** Bathroom    **C** Wall

Toilet lock - when ordering a lock with a lock, choose:

**OUTER lock**                    - when the bathroom lock is to be mounted on the outside of the door (Z)

lub  
**INTERIOR lock**                - when the bathroom lock is to be mounted on the inside of the door (W)

ATTENTION: Locks with locking have direction (right-left)

## METAL COVERS FOR HINGES



Brushed nickel, patina, glossy chrome, glossy brass, white matt and black matt.

for Herse Ø16, length 47 mm in the colours:  
- brushed nickel, patina, glossy chrome, brass, gloss, white and black

for inner sashes Ø15, length 47 mm in the following colours:  
- brushed nickel, patina, glossy chrome, brass, gloss, white and black

## VENTILATION

Wood-like plastic sleeves for STILE doors for GREKO, PREMIUM and CPL decors.



Grilles



## GLAZING

### STANDARD GLAZING OBVERSE



### GLAZING ON REVERSE



**G** smooth side    **M** Matt side with decoration

## VENTILATION

Ventilation undercut not available in rebated door sashes for wall-mounted sliding systems and hidden in the wall.

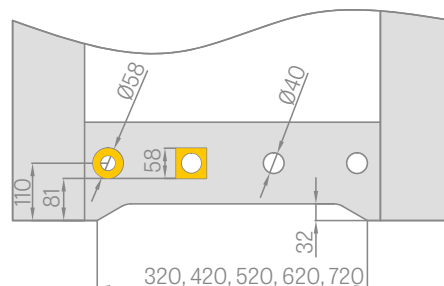

Square and round metal sleeves:



## RECUPERATION

Recuperative shortening - sashes along the entire width are shortened from the bottom with a length of 15 mm. The door has a standard clearance between the sash and the floor about 9 mm, which gives a total clearance of about 24 mm with the recuperation shortening.

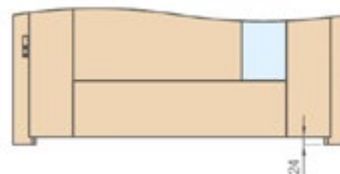

## SHORTING THE SASHES

There is a possibility of shortening the sashes in the PL standard, on one's own, up to a maximum of 50 mm in plate sashes, only with a factory-fitted bottom beam.

NOTE: FRAGI door sashes, double-sash doors, rebated door sashes for sliding systems, GRAF glass doors, and stile and stile doors in the CZ standard cannot be shortened on your own.

The height of the sash made in the so-called the CZ standard is lower than the PL standard by 47 mm.

## GLAZING

Glazing STANDARD AWERS

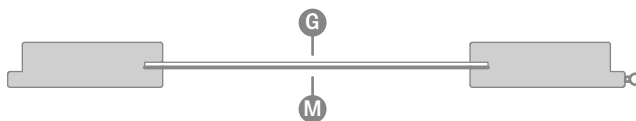

Glazing ON REQUEST REVERS

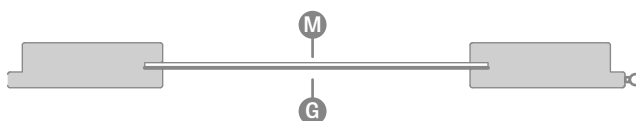

G smooth side M matt side with decoration

## ILLUSTRATION OF GLAZING TRANSPARENCY



**GRAF 1**  
painted tempered glass



**GRAF 12**  
painted tempered glass



**GRAF 8**  
decormat



**GRAF 9**  
transparent



**GRAF 26**  
dark gray



**GRAF 29**  
laminated glass



**Szyba hartowana**  
frosted decormat



**Szyba hartowana**  
transparent

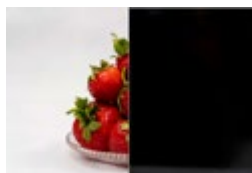

**VSG**  
black

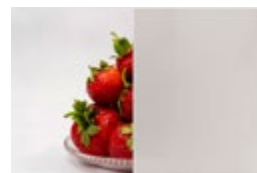

**VSG**  
frosted

## LAMINATED GLASS VSG 221, 331, 441 FROSTED AND BLACK

FOR STILE AND PANEL DOORS

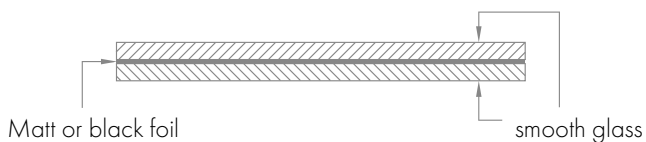

## ELECTRIC LOCK

Available in fixed and adjustable door frames for rebated sashes, but not available for door frames for GRAF glass panels and double-sash doors.

Available types of electric strikes:

- basic 12V
- basic 24V
- with 12V switch
- with 24V switch
- reversible 12 V
- reversible 24 V

### BASIC

It is closed all the time and opens when the voltage is applied.

### WITH SWITCH

It works like the basic one but it can be turned off by moving the latch.

### REVERSING

Applying voltage closes, no voltage opens.

## NON-REBATED AND REVERSIBLE HARDWARE

HIDDEN HINGE

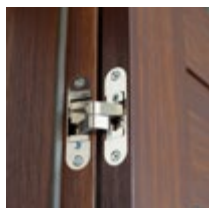

MAGNETIC LOCK



ADJUSTABLE MAGNETIC LOCK CATCH

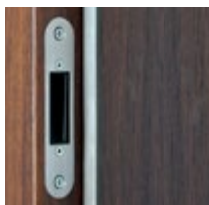

FLUSH SASH WITH THE FRAME



CONCEALED BLACK HINGE



BLACK MAGNETIC LOCK



ADJUSTABLE MAGNETIC LOCK CATCH



## HARDWARE

### Bolt locks

KEY LOCK

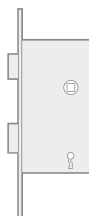

WC LOCK

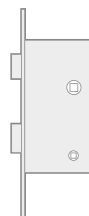

CYLINDER LOCK

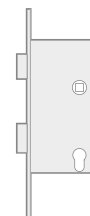

SAVINGS LOCK <sup>1)</sup>



### SPACING OF LOCKS

1. In rebated sashes, the spacing of the lever tumbler lock, WC and cylinder lock is 72 mm.
2. In non-rebated and reversible door sashes, the spacing of the magnetic lock is:
  - key and WC spacing 90 mm
  - insert spacing 85 mm

In toilet locks, the blocking opening is a square with a side of:

- PL standard: 4 mm
- CZ standard: 6 mm

<sup>1)</sup> A key lock is used without opening the key in the door sash.

## DOORING THE FRAME TO NON-REBATED SASHES

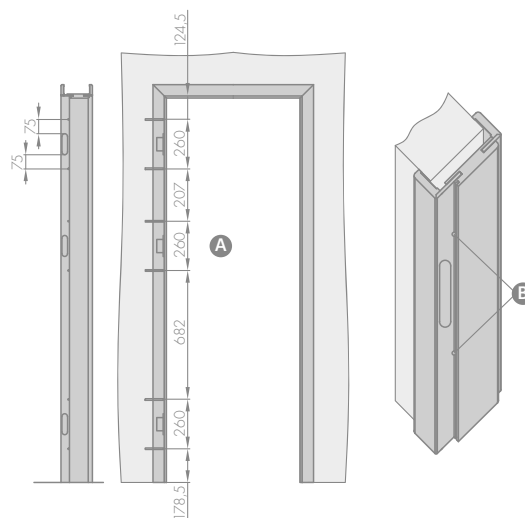

**A** Make holes for metal screws with a length of min. 80mm x  $\varnothing$ 6mm.

**B** When installing the door frame, in addition to the mounting foam on the hinge side, it is required to use mounting anchors. Make the holes for the screws under the gasket so that the installation of the gasket masks them

# SLIDING SYSTEM

WALL-MOUNTED

## WALL SLIDING SYSTEM

**SINGLE SP1Nz (with bolt keeper)**

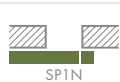

**SINGLE SP1Nb (no bolt keeper)**



**DUAL SP2N**

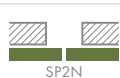

The price includes: an aluminium rail with a cover and a bumper in the colour of the sash length:

- 210 cm to the sash „100”
- 200 cm to the sash „90”
- 180 cm to the sash „80”
- 150 cm to the sash „70”, „60”

Available configurations of sliding wall systems:

- Rail with masking plate and bumper with gasket (only SP1Nz and SP1Nb)
- Rail with masking cover and tunnel frame (only SP2N)
- Rail with cover plate and bumper + tunnel frame (only SP1Nz and SP1Nb)
- Rail with masking plate and bumper with gasket + tunnel frame (only SP1Nz and SP1Nb)

## BOLT KEEPER LOCKS WITH A KEY

Glossy chrome, brushed chrome, shiny brass, matt black

The key is only available in silver. The key bolt keeper lock consists of two selected handles.



## EXTRA CHARGE

- ościeżnica regulowana typu „tuneł” w cenie ościeżnicy regulowanej
- Hook lock with hardware option for single system only
- Handrail: oval, rectangular or round in the following colours: bright chrome, brushed chrome, glossy brass, matt black; a set of handles comprises two pieces
- synchronisation - two sashes can be opened or closed at the same time with only one sash only applies to SP2N
- decelerator - automatic deceleration of the sash in the final closing phase applies only to SP1Nz and SP1Nb
- 2112 standard

## ROUND HANDLES, OVAL, RECTANGULAR <sup>1)</sup>

brushed nickel, patina, glossy chrome, brass, gloss, white and black



<sup>1)</sup> In the BALDUR 8 model, the oval and square handles overlap the moulding.

It is not possible to make an undercut in the door sash without a rebate for the wall-mounted sliding system. The grille is not glued or varnished from the inside.

# WALL SLIDING SYSTEM

WITH FRAME DEVELOPMENT

## SP1NZ OR SP1NB (LEFT OBVERSE VERSION)

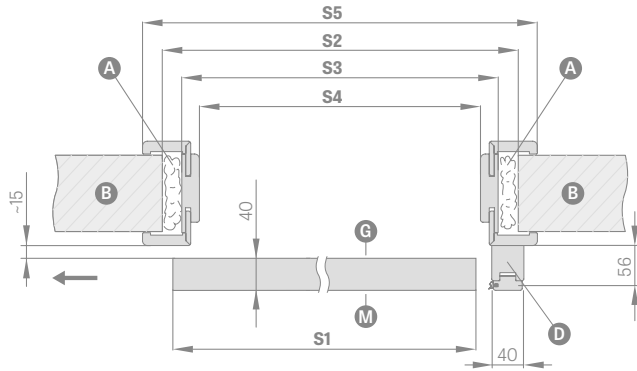

## SP2N (OBVERSE VERSION)

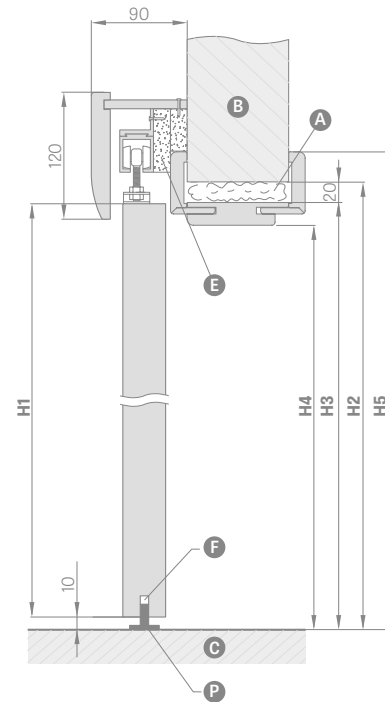
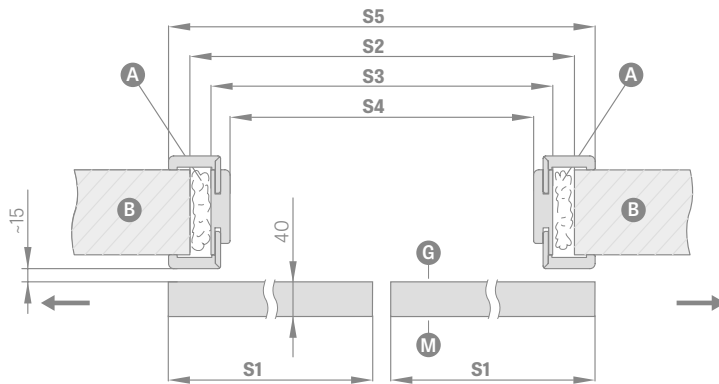

- A foam
- B wall
- C floor
- D fender beam
- E spacer strips
- F milling under the guide
- G smooth side of the glass
- P floor guide
- M matt side of the glass

		WALL-MOUNTED SLIDING SYSTEM WITH FRAME DEVELOPMENT									
		SINGLE-SASH DOOR					DOUBLE DOORS				
		"60"	"70"	"80"	"90"	"100"	"60"x2	"70"x2	"80"x2	"90"x2	"100"x2
<b>S1</b>	Sash width	644	744	844	944	1044	1288	1488	1688	1888	2088
<b>S2</b>	The width of the opening in the wall	688	788	888	988	1088	1288	1488	1688	1888	2088
<b>S3</b>	The outer width of the frame	648	748	848	948	1048	1248	1448	1648	1848	2048
<b>S4</b>	Clear width of the frame	604	704	804	904	1004	1204	1404	1604	1804	2004
<b>S5</b>	Covering width of the door frame headband 6cm/headband 8cm	746/786	846/886	946/986	1046/1086	1146/1186	1346/1386	1546/1586	1746/1786	1946/1986	2146/none
<b>H1</b>	Door sash height	2030 (2112) <sup>1)</sup>									
<b>H2</b>	The height of the opening in the wall	2060 (2142) <sup>1)</sup>									
<b>H3</b>	External height of the frame	2040 (2122) <sup>1)</sup>									
<b>H4</b>	Clear height of the frame	2018 (2100) <sup>1)</sup>									
<b>H5</b>	Frame cover height headband 6cm/headband 8cm	2089/2109 (2171/2191) <sup>1)</sup>									2089/none (2171/2191) <sup>1)</sup>

<sup>1)</sup> PL2112 Standard

# WALL SLIDING SYSTEM

WITHOUT FRAME DEVELOPMENT

## SP1NZ OR SP1NB (LEFT OBVERSE VERSION)

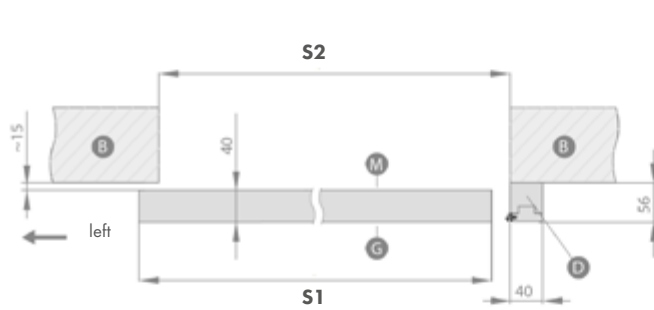

## SP2N (OBVERSE VERSION)

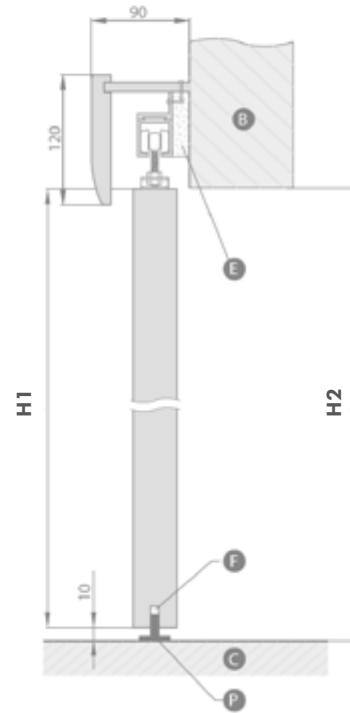
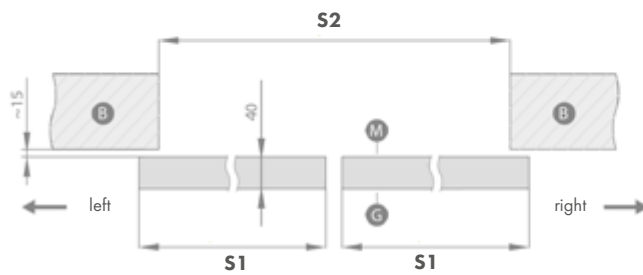

- B** - wall
- C** - floor
- D** - fender beam
- E** - spacer strips
- F** - milling under the guide
- G** - smooth side of the glass
- P** - floor guide
- M** - matt side of the glass

		WALL SLIDING SYSTEM									
		SINGLE-SASH DOOR					DOUBLE DOORS				
		"60"	"70"	"80"	"90"	"100"	"60"x2	"70"x2	"80"x2	"90"x2	"100"x2
<b>S1</b>	Sash width	644	744	844	944	1044	1288	1488	1688	1888	2088
<b>S2</b>	The width of the opening in the wall	602	702	802	902	1002	1202	1402	1602	1802	2002
<b>H1</b>	Door sash height	2030 (2112) <sup>1)</sup>	2030 (2112) <sup>1)</sup>	2030 (2112) <sup>1)</sup>	2030 (2112) <sup>1)</sup>	2030 (2112) <sup>1)</sup>	2030 (2112) <sup>1)</sup>	2030 (2112) <sup>1)</sup>	2030 (2112) <sup>1)</sup>	2030 (2112) <sup>1)</sup>	2030 (2112) <sup>1)</sup>
<b>H2</b>	The height of the opening in the wall	2020 (2102) <sup>1)</sup>	2020 (2102) <sup>1)</sup>	2020 (2102) <sup>1)</sup>	2020 (2102) <sup>1)</sup>	2020 (2102) <sup>1)</sup>	2020 (2102) <sup>1)</sup>	2020 (2102) <sup>1)</sup>	2020 (2102) <sup>1)</sup>	2020 (2102) <sup>1)</sup>	2020 (2102) <sup>1)</sup>

<sup>1)</sup> PL2112 Standard

# WALL SLIDING SYSTEM

## STANDARD LOFT TYPE

### SINGLE SLIDING SYSTEM

#### STANDARD LOFT

Available with all standard sashes SP1N wall-mounted sliding system.

### DOUBLE SLIDING SYSTEM

#### STANDARD LOFT

It consists of two individual systems and a rail connecting element.

Two handles to choose from: INDUSTRIAL and RETRO.



**BALDUR 7 door sash, WHITE TITANIUM UV decor, rectangular black handrail, INDUSTRIAL door handle**

### STANDARD LOFT TYPE SLIDING SYSTEM (OPTIONS FOR AN ADDITIONAL CHARGE)

- OVAL, RECTANGULAR OR ROUND HANDLE <sup>3)</sup>
- SELF-CLOSING ON ONE SIDE
- ELEMENT CONNECTING THE RAILS (ENABLES THE USE OF THE LOFT SYSTEM IN A DOUBLE-SASH SYSTEM)

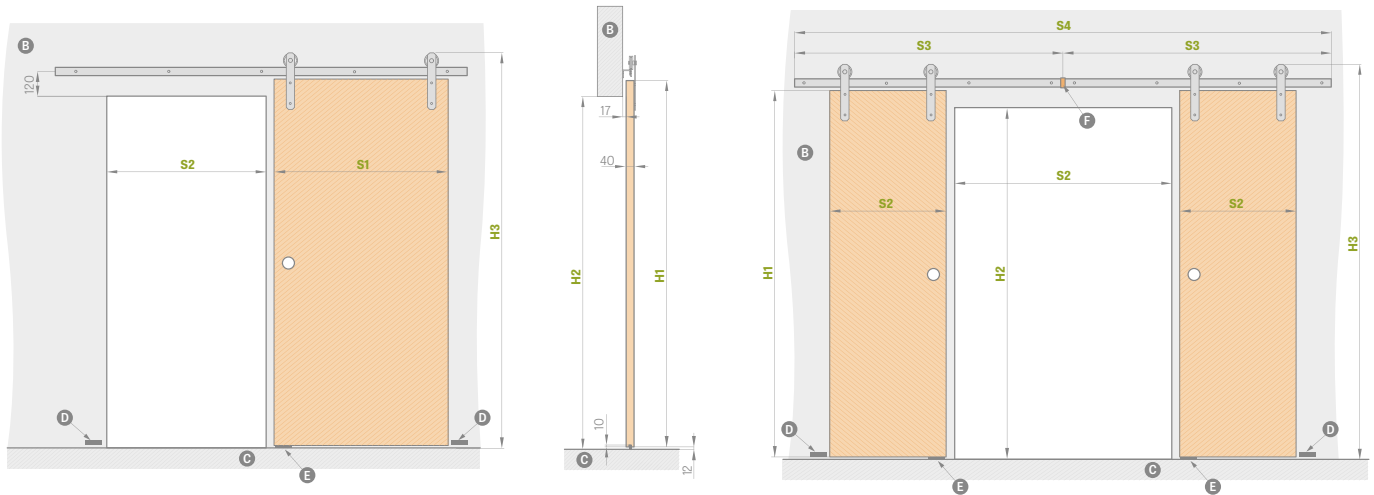

		"60"	"70"	"80"	"90"	"100"
<b>S1</b>	Sash width	644	744	844	944	1044
<b>S2</b>	The width of the opening in the wall <sup>1)</sup>	574	674	774	874	974
<b>H1</b>	Door sash height	2030	2030	2030	2030	2030
<b>H2</b>	The height of the opening in the wall	1962	1962	1962	1962	1962
<b>H3</b>	The total height of the system	2170	2170	2170	2170	2170

		"120"	"140"	"160"	"180"	"200"
<b>S1</b>	Sash width	2x644	2x744	2x844	2x944	2x1044
<b>S2</b>	The width of the opening in the wall <sup>1)</sup>	1202	1402	1602	1802	2002
<b>S3</b>	Guide rail width	1500	1500	2000	2000	2200
<b>S4</b>	Total guide rail width <sup>2)</sup>	3000	3000	4000	4000	4400
<b>H1</b>	Door sash height	2030	2030	2030	2030	2030
<b>H2</b>	The height of the opening in the wall	1962	1962	1962	1962	1962
<b>H3</b>	The total height of the system	2170	2170	2170	2170	2170

### GUIDING RAIL FOR A SINGLE SYSTEM WITH A LENGTH OF:

- **200 cm for sashes "60" "70" "80"**
- **250 cm for sashes "90" "100"**

<sup>1)</sup> The sash in the closed position overlaps 35 mm per side

<sup>2)</sup> The guide in the double-sash system consists of two guides connected with a connector

<sup>3)</sup> In the BALDUR 8 model, the oval and square handrail overlaps the MOULDING

**B** – wall  
**C** – floor  
**D** – bumper mounted in the wall

**E** – guide  
**F** – guide connector <sup>2)</sup>

# WALL SLIDING SYSTEM

## LOFT TYPE

The LOFT type wall-mounted sliding system is available in black and in a set with a full sash type LOFT. The LOFT type door sash is standardly equipped with a stabilizing "honeycomb" filling or with a full board for an additional charge. The sash has an edge in the technology without a rebate.

The system is for a finished hole, there is no tunnel available. The complete system consists of: LOFT sliding system + LOFT sash + handrail + soft-closer on one or both sides.

The LOFT double system consists of two single systems and a rail connecting element. Two handles to choose from: INDUSTRIAL and RETRO.



LOFT SASH, OAK ST CPL decor, RETRO door handles

### LOFT TYPE SLIDING SYSTEM (OPTIONS FOR AN EXTRA CHARGE)

- OVAL, RECTANGULAR OR ROUND HANDLE
- SOLID PLATE FILLING
- ROUND AND SQUARE METAL SLEEVES (4 PCS.); FINISH: BLACK MAT
- DOOR CLOSER ON ONE SIDE
- ELEMENT CONNECTING THE RAILS (ENABLES THE USE OF THE LOFT SYSTEM IN A DOUBLE-SASH SYSTEM)
- BLACK SASH EDGE FINISH

walnut premium	gray maple premium	oak premium	graphite ash premium	nature oak premium	nature oak premium horizontal
	<b>NEW</b>				
white premium <sup>1)</sup>	white ST CPL <sup>1) 2)</sup>	oak ST CPL	gray oak ST CPL	venge ST CPL	gray pine ST CPL
	<b>NEW</b>	<b>NEW</b>	<b>NEW</b>		
white bark premium	cappuccino ST CPL <sup>2)</sup>	light gray ST CPL <sup>2)</sup>	black ST CPL <sup>2)</sup>	concrete premium	white titanium UV
			<b>NEW</b>	<b>NEW</b>	<b>NEW</b>
white CPL 0,2	ash gray CPL 0,2	anthracite CPL 0,2	dark green ST CPL <sup>2)</sup>	royal blue ST CPL <sup>2)</sup>	ash gray ST CPL <sup>2)</sup>

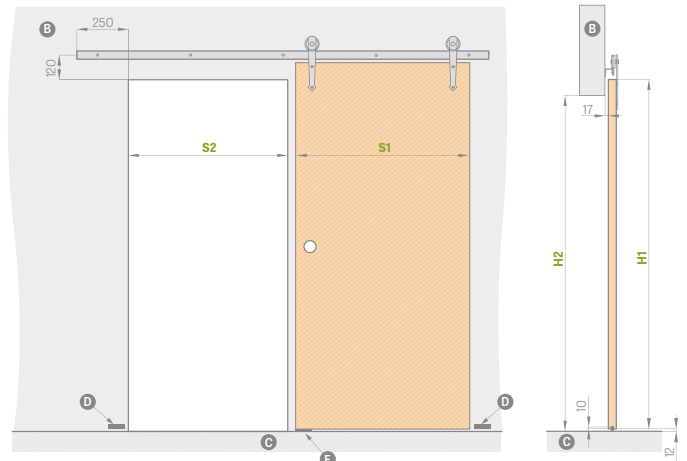

		"60"	"70"	"80"	"90"	"100"
S1	Sash width	644	744	844	944	1044
S2	The width of the opening in the wall	574	674	774	874	974
H1	Door sash height	2150	2150	2150	2150	2150
H2	The height of the opening in the wall	2082	2082	2082	2082	2082

- B - wall
- C - floor
- D - wall-mounted buffer
- E - guide

### HANDLES HOLDING THE SASH



Smooth black sash edge finish



Black transverse finish of the door sash edge



Industrial



Retro

### ROUND HANDLES, OVAL, RECTANGULAR

brushed nickel, patina, glossy chrome, brass, gloss, white and black



### GUIDE LENGTH:

- 200 cm for sash "60" "70" "80"
- 250 cm for sash "90" "100"

<sup>1)</sup> Smooth white veneer imitating painted surface

<sup>2)</sup> A special Antifinger **NEW** coating that reduces dirt and fingerprints

# WALL SLIDING SYSTEM

## MAGIC TYPE

The MAGIC wall-mounted sliding system is only available in sets, with a full sash type MAGIC. The MAGIC type door sash is standardly equipped with a stabilizing "honeycomb" filling or with a solid board at an extra charge. The sash has an edge in the rebateless technology.

The system is for a finished hole, there is no tunnel available. The complete system consists of: MAGIC sliding system + MAGIC sash + handrail.

The system is available only as a set (system + sash).



MAGIC SASH, PREMIUM OAK decor, glossy chrome handle

### MAGIC SLIDING SYSTEM (OPTIONS FOR AN EXTRA CHARGE)

- OVAL, RECTANGULAR OR ROUND HANDLE
- FILLING WITH A SOLID BOARD
- ROUND AND SQUARE METAL SLEEVES (4 PCS.); FINISH: BLACK MAT
- BLACK SASH EDGE FINISH

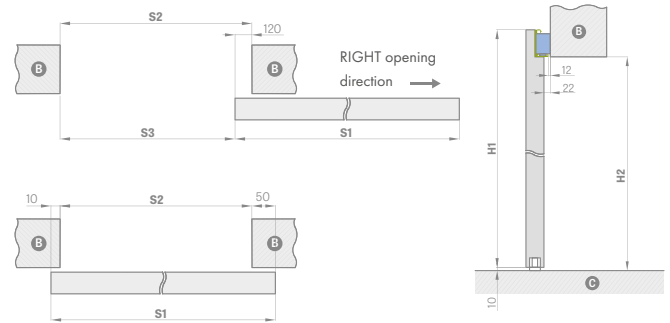
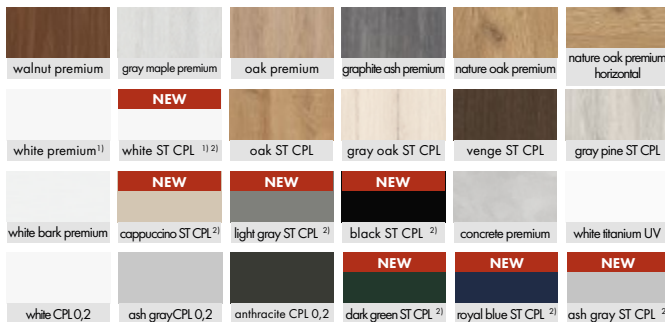

		"60"	"70"	"80"	"90"	"100"
S1	Sash width	644	744	844	944	1044
S2	The width of the opening in the wall	584	684	784	884	984
S3	Passage light	464	564	664	764	864
H1	Door sash height	2150	2150	2150	2150	2150
H2	The height of the opening in the wall	2100	2100	2100	2100	2100

B - wall C - floor

## ROUND HANDLES, OVAL, RECTANGULAR

brushed nickel, patina, glossy chrome, brass, gloss, white and black



Smooth black sash edge finish

Black transverse finish of the door sash edge

<sup>1)</sup> Smooth white veneer imitating a painted surface <sup>2)</sup> A special AntiFinger **NEW** coating that reduces dirt and fingerprints

# WALL SLIDING SYSTEM

GRAF GLASS DOOR



GRAF SYSTEM 8

Sliding system for glass doors with an anodized aluminium cover in silver or powder coated in black mat. This system is complete and used on a finished hole as no tunnel is available. All GRAF glass panes pp. 94-95 are available in the system.

The complete system consists of: SYSTEM GRAF sliding system + SYSTEM GRAF glass pane + handrail + one-sided door closer.

## EXTRA CHARGE

- Double-sided round stainless steel handrail
- Double-sided round aluminium handrail anodized inox colour or black matt (powder coated)
- Double-sided round handrail made of black matt stainless steel
- Surcharge for glass pane "90"
- Self-closing device

WALL SLIDING SYSTEM FOR GLASS DOORS					
		"60"	"70"	"80"	"90"
S1	Sash width	662	762	862	962
S2	The width of the opening in the wall	602	702	802	902
S3	Bar length	1500	1500	1800	2000
H1	Door sash height	2036			
H2	The height of the opening in the wall	max. 2020			
H3	The total height of the system	2114			

**B** - wall  
**C** - floor  
**D** - guide

## GLASS DOOR SLIDING SYSTEM

- anoda silver
- black matt

## HANDLE

Stainless steel, matt black, anodized aluminium

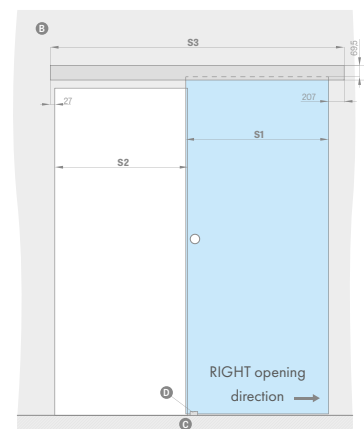
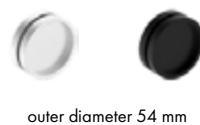
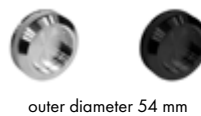

**B** - wall  
**C** - floor

**D** - guide

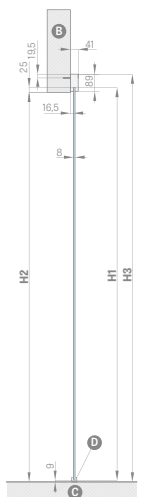





# SLIDING SYSTEMS

HIDDEN IN THE WALL

## TYPES OF SYSTEMS HIDDEN IN THE WALL

**SP1C.100**  Single sliding system hidden in the wall for cassette 100, available only for STILE door sashes, varnished doors and ALTAMURA 1, UNO PREMIUM models.

**SP2C.100**  Double sliding system hidden in the wall for cassette 100 available only for STILE door sashes and the ALTAMURA 1, UNO PREMIUM model.

**SP1C.125**  Single sliding system hidden in the wall for cassette 125.

**SP1C.125**  Double sliding system hidden in the wall for cassette 125.

**ZN1**  One-sided building of the basic wall complementary to the SP1C.100 or SP1C.125 system.

**ZN2**  One-sided building of the basic wall complementary to the SP2C.100 or SP2C.125 system.

Systems not available in CPL0.2 and CPL0.7 laminates

$$\text{The price of the sliding system} = \text{Sash price} + \text{Aluminium cassette price} + \text{Basic tunnel construction price} + \text{Optional price of ZN1 or ZN2 installation}$$

The standard composition of the single/double system hidden in the wall includes the following elements:

- Aluminium cassette [LEON] SP1 – the price of a cassette for a single system.
- Aluminium cassette [LEON] SP2 – the price of the cassette for the double system.
- Door sash without rebate / two door sashes without rebate - price of a standard door sash / price of two sashes.
- Basic tunnel construction (table above).
- Tunnel construction ZN1 or ZN2.

### EXTRA CHARGE

- Joining at 90 degrees.
- Bolt keeper lock with hardware available only for: SP1C.100, SP1C.125.
- Oval, rectangular or round handle available in the following colours: glossy chrome, brushed chrome, glossy brass, black matt. available for SP1C.100, SP2C.100, SP1C.125, SP2C.125 set of handrails consists of two pcs. per set.
- Thimble in the following colours: glossy chrome, brushed chrome, glossy brass, black matt
- Synchronization - simultaneous opening or closing of two sashes takes place only with one sash
- Only available for: SP2C.100, SP2C.125
- Slower: automatic slowing down of the sash in the final phase of closing; only available for SP1C.100, SP1C.125
- Standard 2112

## ROUND HANDLES, OVAL, RECTANGULAR

brushed nickel, patina, glossy chrome, brass, gloss, white and black



## BOLT KEEPER LOCKS WITH A KEY

shiny chrome,  
brushed chrome,  
shiny brass,  
black mat

The key is available only in silver.  
The key bolt keeper lock includes  
two selected handles

The range of one-sided adjustment of the basic wall min - max (mm)

0-40
40-60
60-80
80-100
100-120
120-140
140-160
160-180
180-200
200-220
220-240
240-260
260-280
280-300
300-320
320-340
340-360

One-sided system  
for double doors  
ZN2 + 30%

ADJUSTABLE FRAME		DOUBLE DOORS									
		"60"	"70"	"80"	"90"	"100"	2x "60"	2x "70"	2x "80"	2x "90"	2x "100"
S1	Sash width	644	744	844	944	1044	1288	1488	1688	1888	2088
S2	Clear width of the frame	604	704	804	904	1004	1204	1404	1604	1804	2004
S3	Cassette width	1318	1518	1718	1918	2118	2538	2938	3338	3738	4138
S4	Covering width of the door frame headband 6cm/headband 8cm	746/786	846/886	946/986	1046/1086	1146/1186	1346/1386	1546/1586	1746/1786	1946/1986	2146/none
S5	The width of the opening in the cassette	655	755	855	955	1055	1255	1455	1655	1855	2055
S6	The width of the opening in the wall	1338	1538	1738	1938	2138	2558	2958	3358	3758	4158
H1	Door sash height	2030(2112) <sup>1)</sup>									
H2	The height of the door frame cover band 6 cm / band 8 cm	2092/2112 (2174/2194) <sup>1)</sup>									2092/none (2174/none) <sup>1)</sup>
H3	Cassette height	2115 (2197) <sup>1)</sup>									
H4	Clear height of the frame	2021 (2103) <sup>1)</sup>									
H5	The height of the opening in the wall	2125 (2207) <sup>1)</sup>									

<sup>1)</sup> PL2112 Standard

**SP1C.100** (left obverse glazing)  
fixed range 100 mm

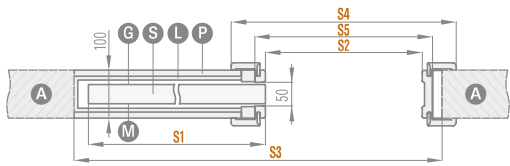

thickness of the cassette before installation with plasterboards - 75 mm

Only for the UNO PREMIUM, ALTAMURA 1 models and for all stile and stile doors. The system does not include and does not require anti-dust brushes.

**SP1C.125** (left obverse glazing)  
fixed range 125 mm

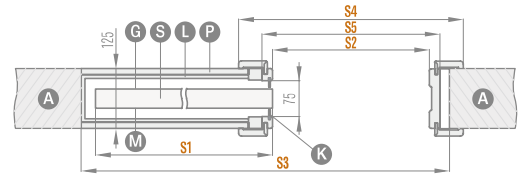

thickness of the cassette before installation with plasterboards - 100 mm

To be used only with board sashes that have a glazing frame. The system includes gray anti-dust brushes.

**SP2C.100** (obverse glazing)  
fixed range 100 mm

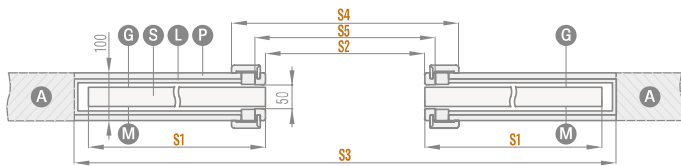

thickness of the cassette before installation with plasterboards - 75 mm

Only for the UNO PREMIUM, ALTAMURA 1 models and for all stile and stile doors. The system does not include and does not require anti-dust brushes.

**SP2C.125** (obverse glazing)  
fixed range 125 mm

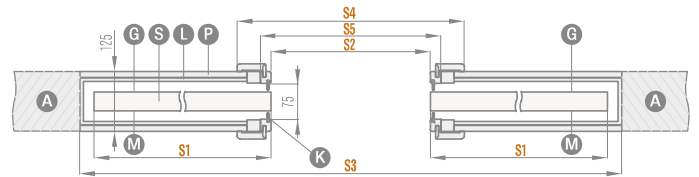

thickness of the cassette before installation with plasterboards - 100 mm

To be used only with board sashes that have a glazing frame. The system includes gray anti-dust brushes.

**ZN1** one-sided construction of the basic wall  
for SP1C.100 and SP1C.125

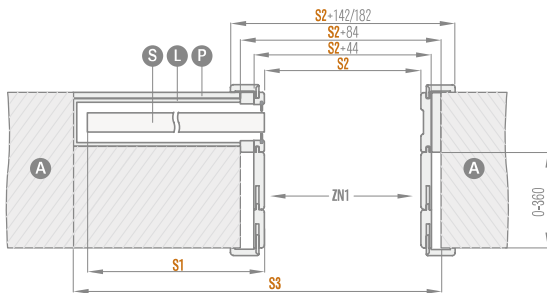

range of building the basic wall from  
0-40; 40-60; ... 340-360

The sketch shows one-sided development of the ZN1 basic wall.

**ZN2** one-sided construction of the basic wall  
for SP2C.100 and SP2C.125

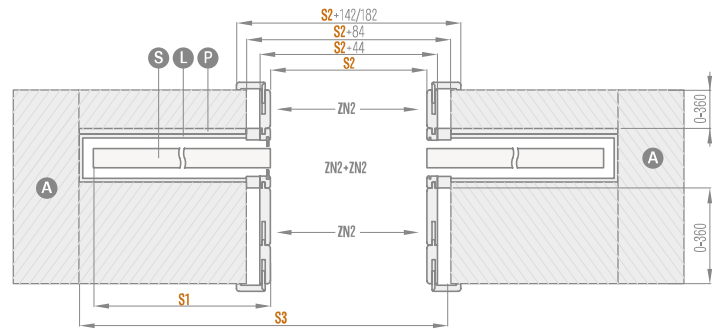

range of building the basic wall from  
0-40; 40-60; ... 340-360

The sketch shows the two-sided construction of the  
ZN2 + ZN2 basic wall.

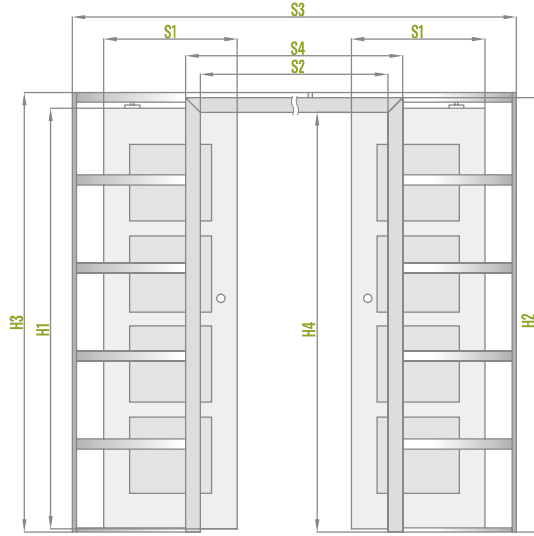
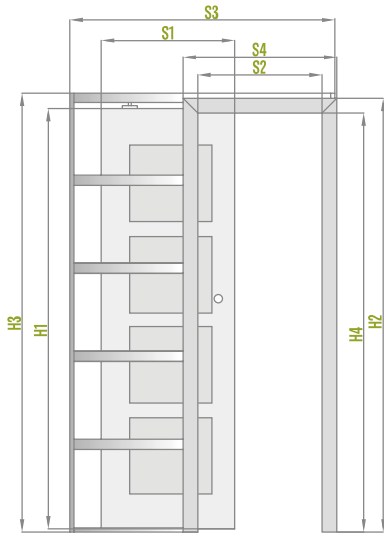

- Ⓐ wall
- Ⓟ drywall board
- Ⓒ smooth side of the glass
- Ⓢ sash
- Ⓛ aluminium cassette
- Ⓚ dust brushes
- Ⓜ frosted side of the glass

# DOUBLE-SASH DOORS

REBATED AND NON-REBATED

## DOUBLE DOORS

- In double-sash doors there is a full panel filling available for an additional charge.
- Double-sash doors are made on the basis of available models of single-sash board and rail doors
- STILE in the corresponding features: colour, finish (STANDARD, SOFT), glazing, etc.
- Double door available in CPL 0.2 and CPL 0.7. The cover strips in the CPL 0.7 sashes are laminated with CPL 0.2
- The inactive sash is equipped with door latches.
- The passive door sash below the width of "60" is available only as a full smooth one - an extra door sash (see the drawing below).
- The extensions are made in the STANDARD edge plate technology. They are available with a honeycomb filling or with a solid plate for an additional charge. The extensions have vertical graining.
- The active and inactive sashes are equipped with closing strips.
- Double-sash doors in non-rebated technology are available only with a magnetic lock.
- Non-rebated double-sash doors are available only with an adjustable door frame.
- The electric strike is not available in double-sash doors.
- PL2112 standard for selected sashes

## PRICES FOR DOUBLE-SASH DOORS

PLATE AND STILE		<b>ACTIVE SASH</b>		<b>PASSIVE SASH</b>
		60 70 80 90 100		60 70 80 90*
PRICE OF A DOUBLE-SASH DOOR WITH A COVER STRIP	=	SASH PRICE X2	+	COVER STRIPS
PLATE AND STILE		<b>ACTIVE SASH</b>		<b>PASSIVE EXTENSIONS</b>
		60 70 80 90 100		30 40 50
PRICE OF A DOUBLE-SASH DOOR WITH A COVER STRIP	=	SASH PRICE	+	FULL EXTENSION WITH COVER STRIPS

- Fixed and adjustable door frame price for double-sash doors + 30%.
- Surcharge for a full plate in the delivery.
- Painted only fully smooth WHITE TITANIUM UV.

\* does not apply to non-rebated door sashes

## AVAILABLE SASH WIDTHS

- DOUBLE SASHES from "120" to "190"\*\*\* and combinations with a full smooth side panel.

60 + 30*	70 + 30*	80 + 30*	90 + 30*	100 + 30*
60 + 40*	70 + 40*	80 + 40*	90 + 40*	100 + 40*
60 + 50*	70 + 50*	80 + 50*	90 + 50*	100 + 50*

\* Extension available only in standard technology as full smooth

\*\*\* Up to "180" for non-rebated

# DOUBLE DOORS

NON-REBATED

## NON-REBATED DOUBLE-SASH DOOR WITH AN ADJUSTABLE FRAME

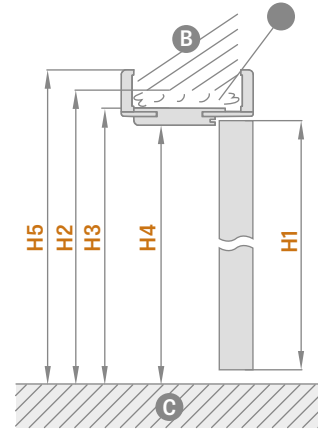
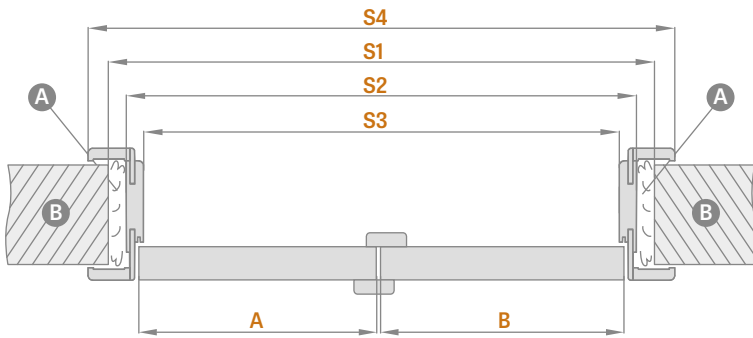

A - foam B - wall C - floor

ADJUSTABLE FRAME		DOUBLE DOORS									
		"90"	"100"	"110"	"120"	"130"	"140"	"150"	"160"	"170"	"180"
A+B	Sash width	988	1088	1188	1288	1388	1488	1588	1688	1788	1888
S1	The width of the opening in the wall	1061	1161	1261	1361	1461	1561	1661	1761	1861	1961
S2	The outer width of the frame	1021	1121	1221	1321	1421	1521	1621	1721	1821	1921
S3	Clear width of the frame	977	1077	1177	1277	1377	1477	1577	1677	1777	1877
S4	Covering width of the door frame headband 6cm/headband 8cm	1119/1159	1219/1259	1319/1359	1419/1459	1519/1559	1619/1659	1719/1759	1819/1859	1919/1959	2019/2059
H1	Door sash height	2030 (2112) <sup>2</sup>									
H2	The height of the opening in the wall	2073 (2155) <sup>2</sup>									
H3	External height of the frame	2053 (2135) <sup>2</sup>									
H4	Clear height of the frame	2031 (2113) <sup>2</sup>									
H5	Frame cover height headband 6cm/headband 8cm	2102/2122 (2184/2204) <sup>2</sup>									

<sup>2</sup> PL2112 Standard

### DOUBLE DOORS - SYMMETRICAL



### DOUBLE DOORS - ASYMMETRIC



### DOUBLE DOORS - WITH FULL SMOOTH EXTENSION

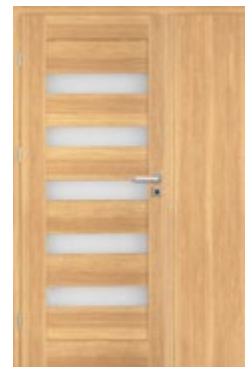

# DOUBLE DOORS

REBATED

## DOUBLE-SASH REBATED DOOR ADJUSTABLE DOOR FRAME

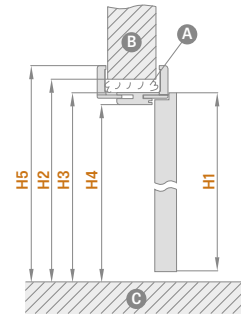
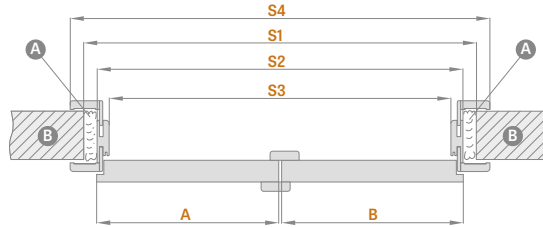

A- foam B- wall C- floor

ADJUSTABLE DOOR FRAME		DOUBLE DOORS										
		"90"	"100"	"110"	"120"	"130"	"140"	"150"	"160"	"170"	"180"	"190"
A+B	Sash width	988	1088	1188	1288	1388	1488	1588	1688	1788	1888	1988
S1	The width of the opening in the wall	1034	1134	1234	1334	1434	1534	1634	1734	1834	1934	2034
S2	The outer width of the frame	994	1094	1194	1294	1394	1494	1594	1694	1794	1894	1994
S3	Clear width of the frame	950	1050	1150	1250	1350	1450	1550	1650	1750	1850	1950
S4	Covering width of the door frame headband 6cm/headband 8cm	1092/1132	1192/1232	1292/1332	1392/1432	1492/1532	1592/1632	1692/1732	1792/1832	1892/1932	1992/2032	2092/2132
H1	Door sash height	2030 [2112] <sup>2</sup>										
H2	The height of the opening in the wall	2060 [2142] <sup>2</sup>										
H3	External height of the frame	2040 [2122] <sup>2</sup>										
H4	Clear height of the frame	2018 [2100] <sup>2</sup>										
H5	Frame cover height headband 6cm/headband 8cm	2089/2109 [2171/2191] <sup>2</sup>										

## DOUBLE-SASH REBATED DOOR FIXED FRAME

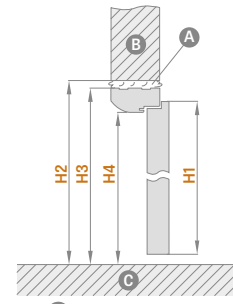
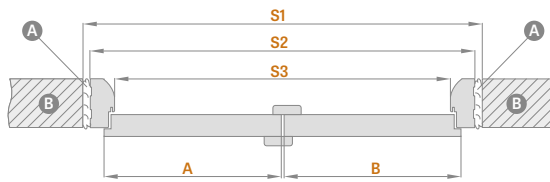

A- foam B- wall C- floor

<sup>2</sup>PL2112 Standard

FIXED DOOR FRAME		DOUBLE DOORS										
		"90"	"100"	"110"	"120"	"130"	"140"	"150"	"160"	"170"	"180"	"190"
A+B	Sash width	988	1088	1188	1288	1388	1488	1588	1688	1788	1888	1988
S1	The width of the opening in the wall	1068	1168	1268	1368	1468	1568	1668	1768	1868	1968	2068
S2	The outer width of the frame	1038	1138	1238	1338	1438	1538	1638	1738	1838	1938	2038
S3	Clear width of the frame	950	1050	1150	1250	1350	1450	1550	1650	1750	1850	1950
H1	Door sash height	2030	2030	2030	2030	2030	2030	2030	2030	2030	2030	2030
H2	The height of the opening in the wall	2077	2077	2077	2077	2077	2077	2077	2077	2077	2077	2077
H3	External height of the frame	2062	2062	2062	2062	2062	2062	2062	2062	2062	2062	2062
H4	Clear height of the frame	2018	2018	2018	2018	2018	2018	2018	2018	2018	2018	2018



# COVERT HIDDEN DOOR SYSTEM

OPENING IN AND OUT



## CONSTRUCTION

- Rebated or non-rebated door sash.
- Wooden rail and stile set covered with two HDF boards.
- "Honeycomb" stabilizing filling or full board filling for an extra charge.

## FINISH

- HDF board covered with PREMIUM veneer, UV varnish or veneer intended for painting or wallpapering.
- Sash edge made in rebated or non-rebated technology.

## HARDWARE

- Always two concealed hinges recessed into the door frame (the third one is optional for an extra charge).
- Magnetic lock in the rebated and non-rebated door sash, key-operated, cylinder lock, economy lock or lockable.

AVAILABLE **DOOR SASH WIDTHS**

60 70 80 90 100

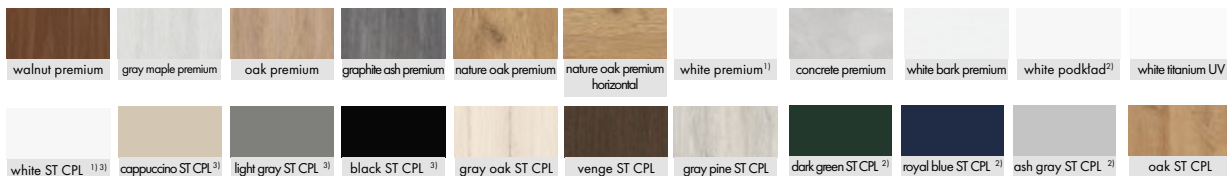

## EXTRA CHARGE

Door frame in white or black.<sup>4)</sup>

WHITE TITANIUM UV varnished door sash

Full board filling.

Additional bottom beam (can be shortened on your own to a maximum of 8 cm).

Round and square metal sleeves (4 pcs.) finish: brushed nickel, patina, white and black.

Inlays LUX

Black sash edge finish

Wood-like plastic sleeves (4 pcs.)

Ventilation undercut lub Ventilation grille.

"100" sash.

Drop down gasket.

Third hinge.

Replaced with hinges and strike plate in black  
 – for two hinges or  
 – for three hinges

Standard 2112

<sup>1)</sup> Smooth white veneer imitating painted surface.

<sup>2)</sup> Used for wallpapering and painting.

<sup>3)</sup> Special AntiFinger coating to reduce dirt and fingerprints.

<sup>4)</sup> The standard door frame is in aluminium colour.

# HIDDEN DOOR SYSTEM

REBATED SASH OPENING INWARDS

## REBATED SASH

STANDARD DIMENSIONS FOR DOORS  
**REBATED DOORS OPENING INWARDS**

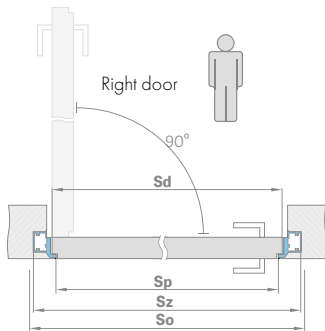
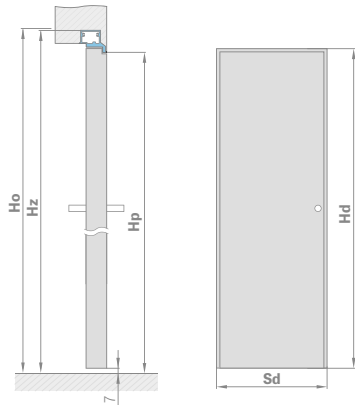

## SECTION OF THE ALUMINIUM FRAME

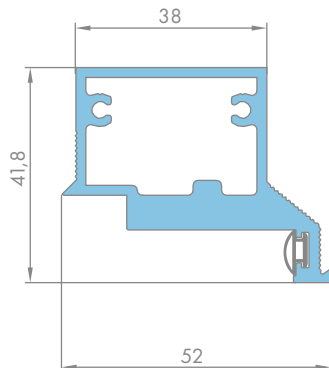

## ALUMINIUM COVERED DOOR FRAME

Sash width	The width of the building opening	The outer width of the frame	Clearance width
Sd (mm)	So (mm)	Sz (mm)	Sp (mm)
620	700	690	605
720	800	790	705
820	900	890	805
920	1000	990	905
1020	1100	1090	1005

Door sash height	The height of the building opening	External height of the frame	Clearance height
Hd (mm)	Ho (mm)	Hz (mm)	Hp (mm)
2030 (2112) <sup>1)</sup>	2079 (2162) <sup>1)</sup>	2072 (2154) <sup>1)</sup>	2030 (2112) <sup>1)</sup>

## G-K BOARD INSTALLATION

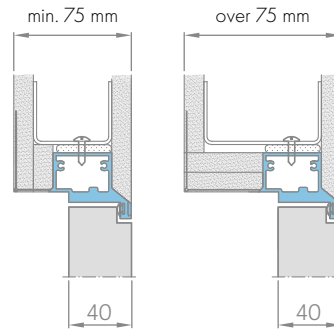

## INSTALLATION IN WALL

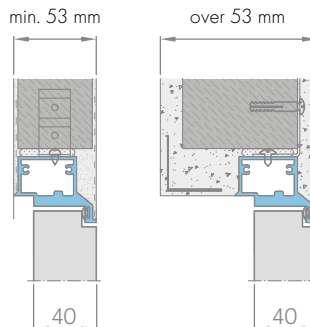

# HIDDEN DOOR SYSTEM

NON-REBATED SASH OPENED OUTWARDS

## NON-REBATED DOOR SASH

STANDARD DIMENSIONS FOR DOORS  
NON-REBATED OPENING TO THE OUTSIDE

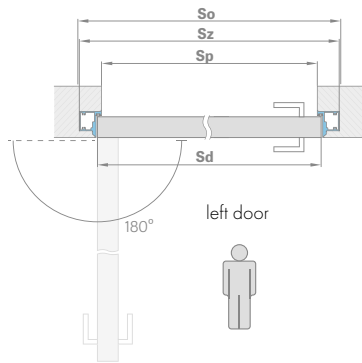
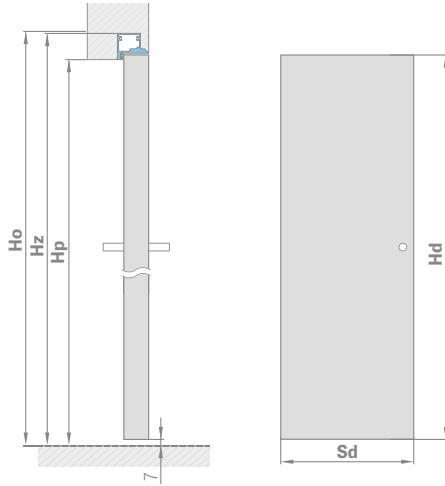

## ALUMINIUM COVERED DOOR FRAME

Sash width	The width of the building opening	The outer width of the frame	Clearance width
$S_d$ (mm)	$S_o$ (mm)	$S_z$ (mm)	$S_p$ (mm)
620	700	690	605
720	800	790	705
820	900	890	805
920	1000	990	905
1020	1100	1090	1005

Door sash height	The height of the building opening	External height of the frame	Clearance height
$H_d$ (mm)	$H_o$ (mm)	$H_z$ (mm)	$H_p$ (mm)
2020 (2102) <sup>1)</sup>	2069 (2152) <sup>1)</sup>	2062 (2144) <sup>1)</sup>	2020 (2102) <sup>1)</sup>

## G-K BOARD INSTALLATION

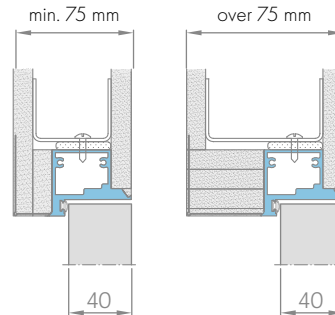

## SECTION OF THE ALUMINIUM FRAME

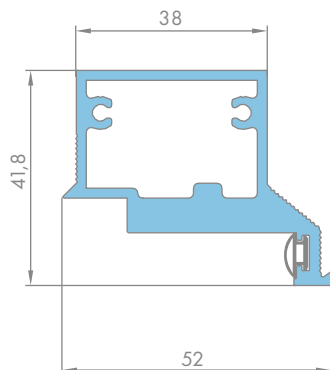

## INSTALLATION IN WALL

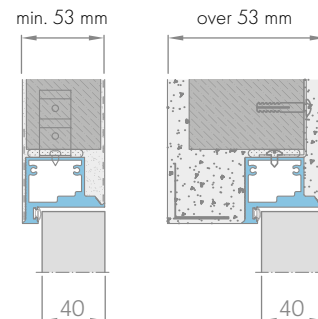

# DOOR FRAMES

- The adjustable rebated and fixed rebated door frame can be used for all types of ERKADO internal doors made in board and STILE technology.
- Non-rebated adjustable door frame can be used for internal doors made in board and STILE technology. These door frames have three hidden hinges.
- The door frame is made of high-quality MDF and covered with a durable foil imitating wood or covered with a durable UV varnish.
- Depending on the technology, the door frames are covered with the following types of finishes: FINISH, GREKO, CPL, PREMIUM and UV varnish.
- Frames for STILE doors have an additional third hinge as standard.
- The set of each adjustable or fixed door frame includes: loose door frame elements, hinges and screws. The individual elements in the places of connection have prepared holes.
- Each set includes assembly instructions and a warranty card.
- The fixed door frame for the Herse collection is rectangular and has a glued wood core.

ADJUSTABLE DOOR FRAME  
**REBATED SASHES**



ADJUSTABLE DOOR FRAME  
**NON-REBATED DOOR SASHES**



FIXED STAND FRAME  
**REBATED SASHES**



REVERSING FRAME  
**REBATED SASHES**



ANGLE BAR WITH AN EXTENDED TONGUE  
**FOR THE ADJUSTABLE DOOR FRAME**  
headband 6cm/headband 8cm



STANDARD ANGLE BAR  
**FOR THE ADJUSTABLE DOOR FRAME**  
headband 6cm/headband 8cm



### FIXED DOOR FRAME STANDARD PL

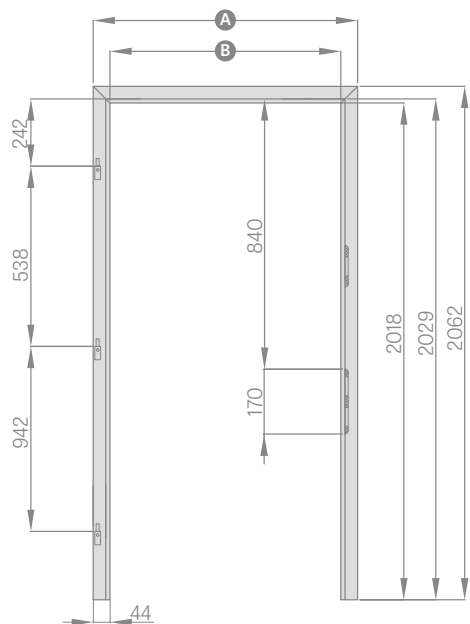

	"60"	"70"	"80"	"90"	"100"
A	692	792	892	992	1092
B	604	704	804	904	1004

### FIXED DOOR FRAME STANDARD CZ

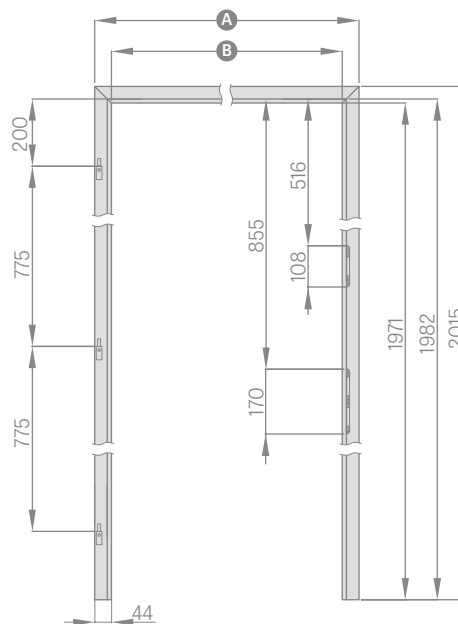

	"60"	"70"	"80"	"90"	"100"
A	692	792	892	992	1092
B	604	704	804	904	1004

### ADJUSTABLE DOOR FRAME STANDARD PL

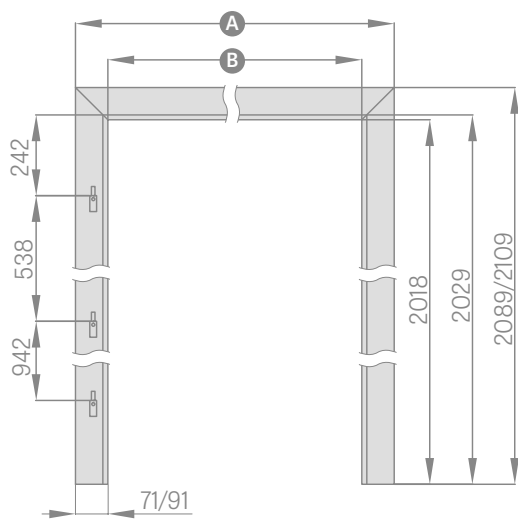

	"60"	"70"	"80"	"90"	"100"
A	746/786	846/886	946/986	1046/1086	1146/1186
B	604	704	804	904	1004

### ADJUSTABLE DOOR FRAME STANDARD CZ

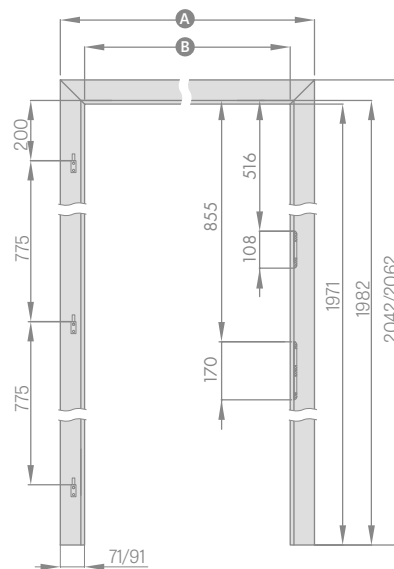

	"60"	"70"	"80"	"90"	"100"
A	746/786	846/886	946/986	1046/1086	1146/1186
B	604	704	804	904	1004

**FIXED DOOR FRAME**  
FOR DOUBLE-SASH DOORS  
STANDARD PL

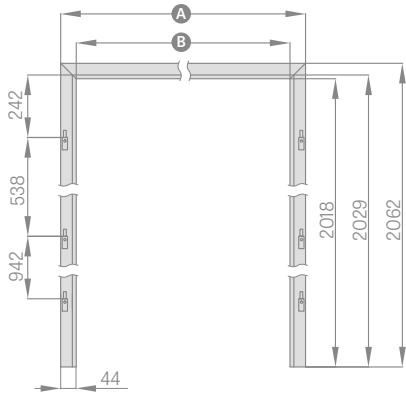

	"90"	"100"	"110"	"120"	"130"	"140"
A	1038	1138	1238	1338	1438	1538
B	950	1050	1150	1250	1350	1450

	"150"	"160"	"170"	"180"	"190"
A	1638	1738	1838	1938	2038
B	1550	1650	1750	1850	1950

**FIXED DOOR FRAME**  
FOR DOUBLE-SASH DOORS  
STANDARD CZ

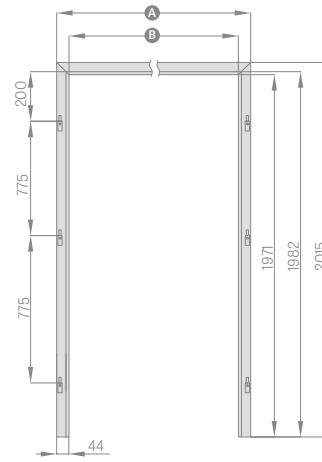

	"90"	"100"	"110"	"120"	"130"	"140"
A	1038	1138	1238	1338	1438	1538
B	950	1050	1150	1250	1350	1450

	"150"	"160"	"170"	"180"	"190"
A	1638	1738	1838	1938	2038
B	1550	1650	1750	1850	1950

**ADJUSTABLE DOOR FRAME**  
FOR DOUBLE-SASH DOORS  
STANDARD PL

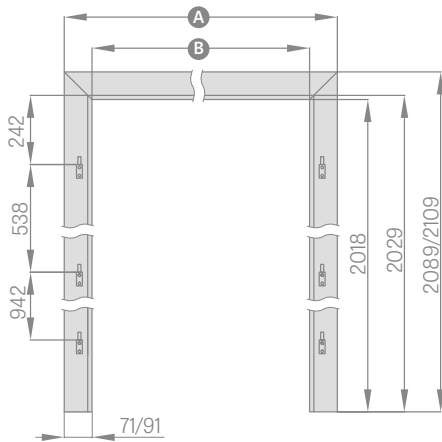

	"90"	"100"	"110"	"120"	"130"	"140"
A	1092/1132	1192/1232	1292/1332	1338	1438	1538
B	950	1050	1150	1250	1350	1450

	"150"	"160"	"170"	"180"	"190"
A	1692/1732	1792/1832	1892/1932	1992/2032	2092/2132
B	1550	1650	1750	1850	1950

**ADJUSTABLE DOOR FRAME**  
FOR DOUBLE-SASH DOORS  
STANDARD CZ

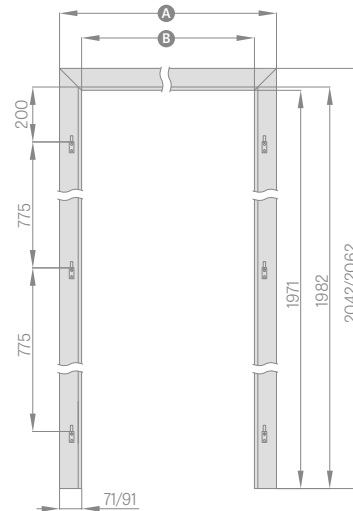

	"90"	"100"	"110"	"120"	"130"	"140"
A	1092/1132	1192/1232	1292/1332	1392/1432	1492/1532	1592/1632
B	950	1050	1150	1250	1350	1450

	"150"	"160"	"170"	"180"	"190"
A	1692/1732	1792/1832	1892/1932	1992/2032	2092/2132
B	1550	1650	1750	1850	1950

**FIXED FRAME FOR GLASS DOORS**  
STANDARD PL

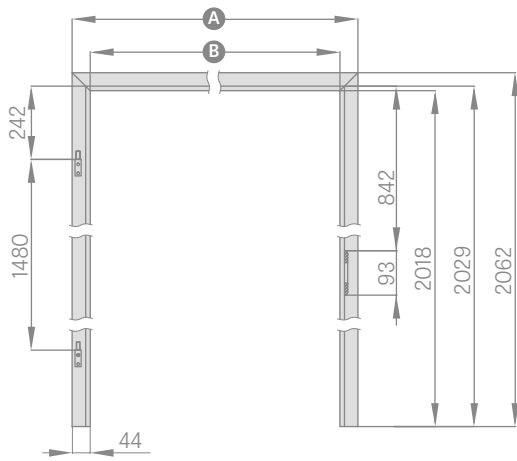

	"60"	"70"	"80"	"90"
A	692	792	892	992
B	604	704	804	904

Door frames for glass panes use a hinge with a 10 mm pin.

**FIXED FRAME FOR GLASS DOORS**  
STANDARD CZ

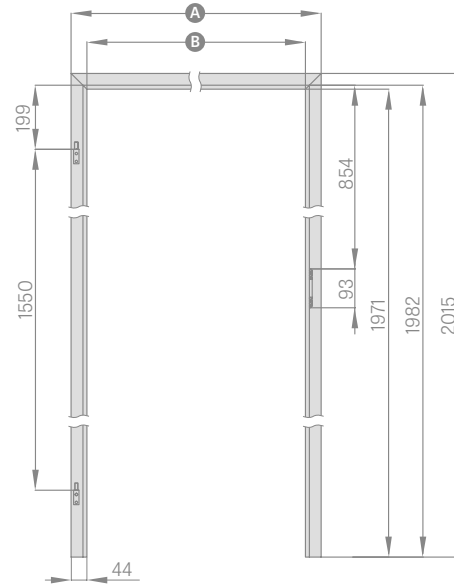

	"60"	"70"	"80"	"90"
A	692	792	892	992
B	604	704	804	904

**ADJUSTABLE DOOR FRAME**  
FOR GLASS DOORS  
STANDARD PL

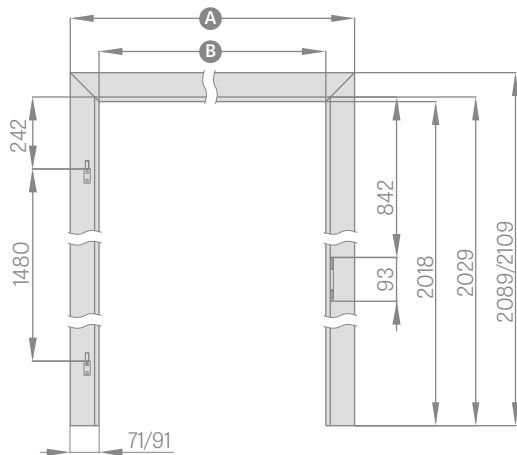

	"60"	"70"	"80"	"90"
A	746/796	846/896	946/996	1046/1096
B	604	704	804	904

Headband 6 cm/ headband 8 cm.  
Door frames for glass panes use a hinge with a 10 mm pin.

**ADJUSTABLE DOOR FRAME**  
FOR GLASS DOORS  
STANDARD CZ

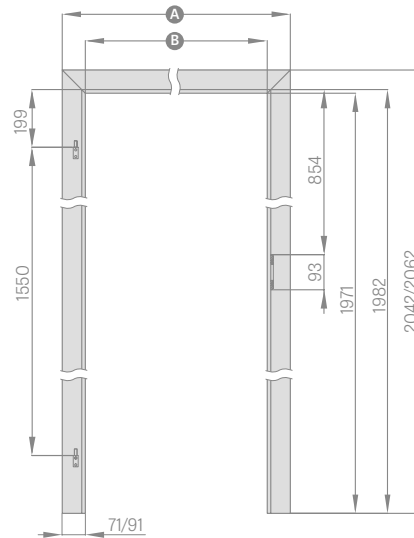

	"60"	"70"	"80"	"90"
A	746/796	846/886	946/986	1046/1086
B	604	704	804	904

Headband 6 cm/ headband 8 cm.

**ADJUSTABLE REBATED DOOR FRAME**  
PL2112 STANDARD

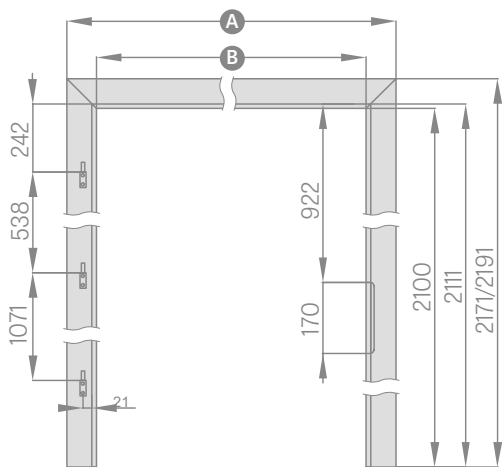

	"60"	"70"	"80"	"90"	"100"
A	746/786	846/886	946/986	1046/1086	1146/1186
B	604	704	804	904	1004

**NON-REBATED ADJUSTABLE DOOR FRAME**  
STANDARD CZ

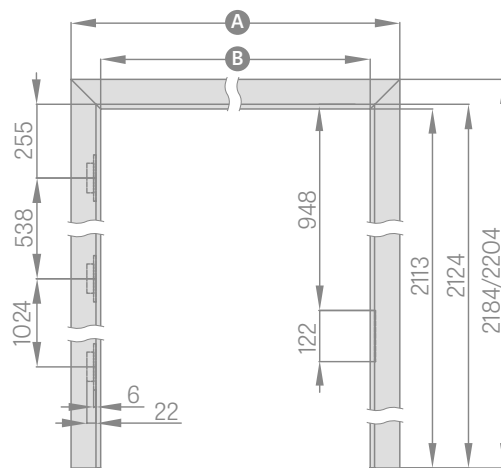

	"60"	"70"	"80"	"90"	"100"
A	771/811	871/911	947/987	971/1011	1071/1211
B	629	729	829	929	1029

**ADJUSTABLE REBATED DOOR FRAME**  
PL2112 STANDARD

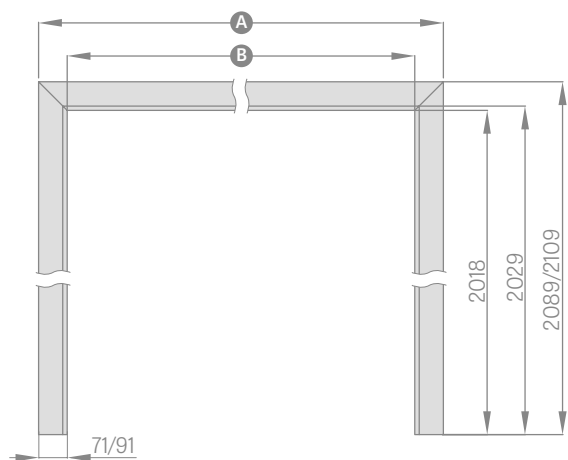

	"60"	"70"	"80"	"90"	"100"	"110"	"120"
A	764/786	864/886	964/986	1064/1086	1164/1186	1264/1286	1364/1386
B	604	704	804	904	1004	1104	1204

	"130"	"140"	"150"	"160"	"170"	"180"	"190"
A	1464/1486	1564/1586	1664/1686	1764/1786	1864/1886	1964/1986	2064/2086
B	1304	1404	1504	1604	1704	1804	1904

Headband 6 cm / headband 8 cm.

**NON-REBATED ADJUSTABLE DOOR FRAME**  
STANDARD PL

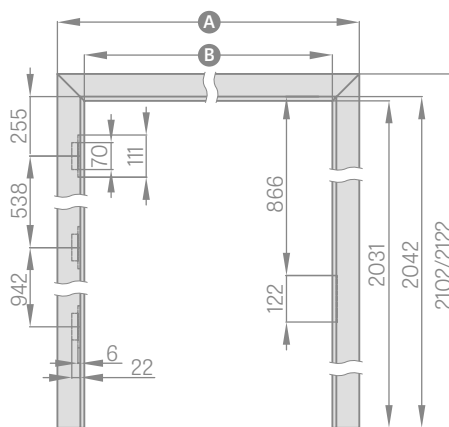

	"60"	"70"	"80N"	"80"	"90"	"100"
A	771/811	871/911	947/987	971/1011	1071/1111	1171/1211
B	629	729	805	829	929	1029

**NON-REBATED ADJUSTABLE DOOR FRAME**  
PL2112 STANDARD

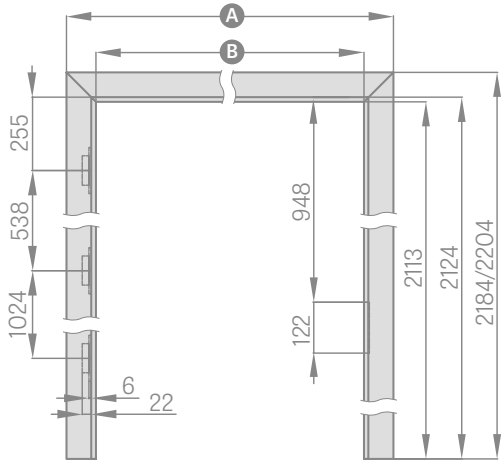

	"60"	"70"	"80N"	"80"	"90"	"100"
A	771/811	871/911	947/987	971/1011	1071/1111	1171/1211
B	629	729	805	829	929	1029

**REVERSIBLE DOOR FRAME**

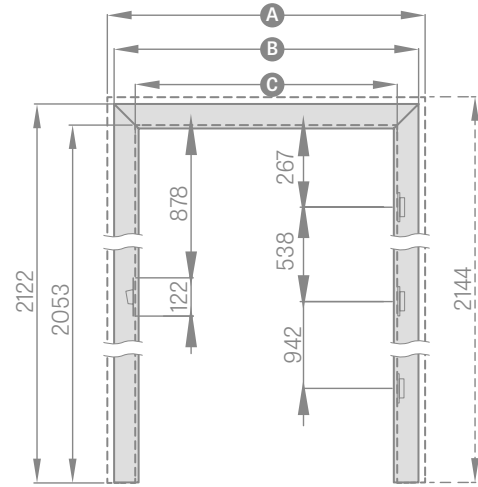

	"60"	"70"	"80N"	"80"	"90"	"100"	"110"
A	834	934	1010	1034	1134	1234	1334
B	791	891	967	991	1091	1191	1291
C	652	752	828	852	952	1052	1152

**NON-REBATED ADJUSTABLE DOOR FRAME**  
PL2112 STANDARD

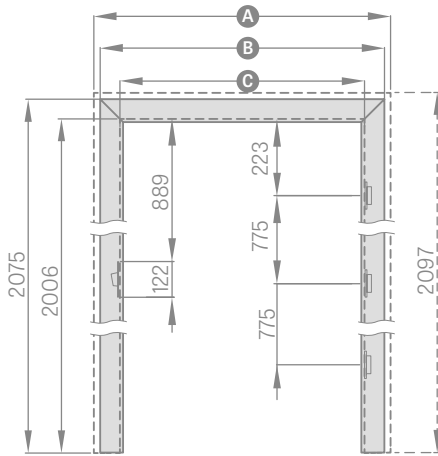

	"60"	"70"	"80N"	"80"	"90"	"100"	"110"
A	834	934	1010	1034	1134	1234	1334
B	791	891	967	991	1091	1191	1291
C	652	752	828	852	952	1052	1152

# ADJUSTABLE TUNNEL FRAME

REBATED, NON-REBATED

## TUNNEL FRAMES

The tunnel frame is an adjustable frame without any hardware. It consists of an upper beam and two vertical beams.

It can be used to finish door openings as an element of protecting wall corners, however, it is usually used for aesthetic purposes as a decoration of the interior of a given room.

Tunnel-type adjustable rebated door frames are also used in ERKADO sliding systems.

Tunnel type non-rebated adjustable door frames are not used for sliding systems.

Depending on the system, we use rebated tunnels:

SLIDING SYSTEM  
**SINGLE WALL MOUNTED**

TUNNEL TO  
**SP1N**

SLIDING SYSTEM  
**DOUBLE WALL**

TUNNEL TO  
**SP2N**

	REBATED ADJUSTABLE TUNNELS													
	"60"	"70"	"80"	"90"	"100"	"110"	"120"	"130"	"140"	"150"	"160"	"170"	"180"	"190"
The width of the opening in the wall	688	788	888	988	1088	1188	1288	1388	1488	1588	1688	1788	1888	1988
The outer width of the tunnel	648	748	848	948	1048	1148	1248	1348	1448	1548	1648	1748	1848	1948
Width in the light of the tunnel	604	704	804	904	1004	1104	1204	1304	1404	1504	1604	1704	1804	1904
Tunnel covering width band 6 cm / band 8 cm	746/ 786	846/ 886	946/ 986	1046/ 1086	1146/ 1186	1246/ 1286	1346/ 1386	1446/ 1486	1546/ 1586	1646/ 1686	1746/ 1786	1846/ 1886	1946/ 1986	2046/ 2086
The height of the opening in the wall	2060 (2142) <sup>1)</sup>													
External height of the tunnel	2040 (2122) <sup>1)</sup>													
Tunnel height	2018(2100) <sup>1)</sup>													
Tunnel covering height band 6 cm / band 8 cm	2089/2109 (2171/2191) <sup>1)</sup>													

<sup>1)</sup> PL2112 Standard

	NON-REBATED ADJUSTABLE TUNNELS													
	"60"	"70"	"80"	"90"	"100"	"110"	"120"	"130"	"140"	"150"	"160"	"170"	"180"	
The width of the opening in the wall	713	813	913	1013	1113	1213	1313	1413	1513	1613	1713	1813	1913	
The outer width of the tunnel	673	773	873	973	1073	1173	1273	1373	1473	1573	1673	1773	1873	
Width in the light of the tunnel	629	729	829	929	1029	1129	1229	1329	1429	1529	1629	1729	1829	
Tunnel covering width band 6 cm / band 8 cm	771/ 811	871/ 911	971/ 1011	1071/ 1111	1171/ 1211	1271/ 1311	1371/ 1411	1471/ 1511	1571/ 1611	1671/ 1711	1771/ 1811	1871/ 1911	1971/ 2011	
The height of the opening in the wall	2073 (2155) <sup>1)</sup>													
External height of the tunnel	2053 (2135) <sup>1)</sup>													
Tunnel height	2031 (2113) <sup>1)</sup>													
Tunnel covering height band 6 cm / band 8 cm	2102/2122 (2184/2204) <sup>1)</sup>													

<sup>1)</sup> PL2112 Standard

# REVERSING FRAME

REVERSIBLE SASHES

DOOR WIDTH	A	B	C	D	E	F	G
*60"	624	644	652	696	736	834	791
*70"	724	744	752	796	836	934	891
*80"	824	844	852	896	936	1034	991
*90"	924	944	952	996	1036	1134	1091
*100"	1024	1044	1052	1096	1136	1234	1191

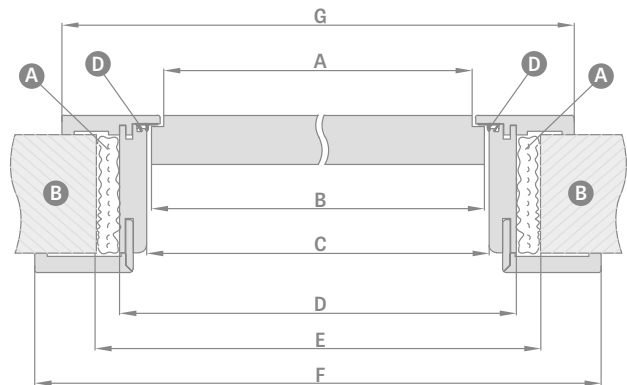
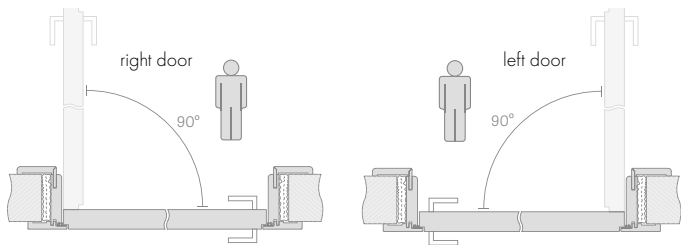

HEIGHT IN **PL** STANDARD\*

HEIGHT IN **CZ** STANDARD\*  
(-47mm)

Adjustment range	min-max (mm)
95-115	
115-135	
135-155	
155-175	
175-195	
195-215	
215-235	
235-255	
255-295	
295-315	
315-335	
335-355	

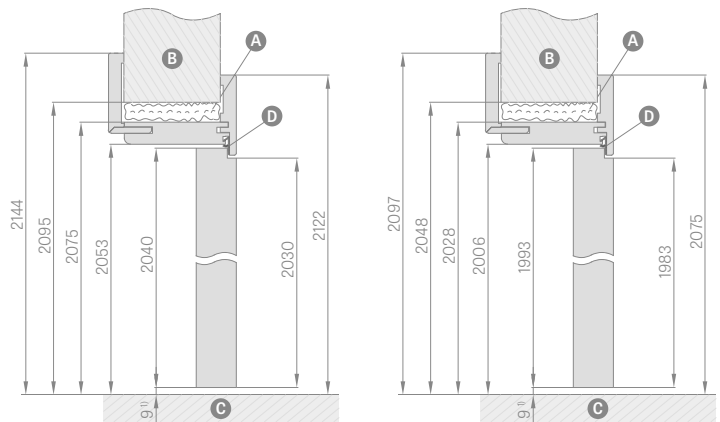
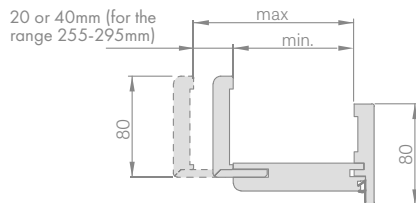

**A** foam **B** wall **C** floor **D** rubber gasket

- The door frame for reversible sashes is available only with an 8 cm angle bar joined at an angle of 45 degrees or at an additional cost joined at an angle of 90 degrees (not available in the range of 75-95mm).
- Available decors from the colour group: GREKO, PREMIUM, ST CPL and White Titanium UV lacquer.
- 120 mm extension to the reversible veneer door frame and varnished.

- A movable angle bar with a tongue extended by 2 cm and a standard angle bar for the adjustable door frame, available in all veneers and varnishes.
- The door frame with a range exceeding 295 mm consists of two elements.
- The door frame contains two so-called hidden hinges invisible when the sash is closed
- Replaced with hinges and striker plate in black.

# ADJUSTABLE FRAME

NON-REBATED DOOR SASHES

## ADJUSTABLE FRAME RANGE 80-95MM

headband 6cm/headband 8cm

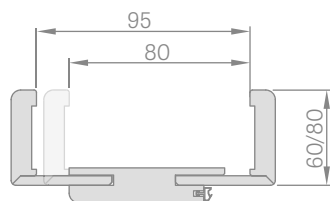

## CONNECTION DOOR FRAME

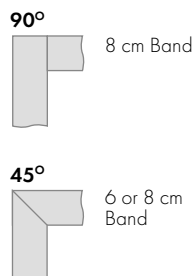

## DIAGRAM ADJUSTABLE FRAME

headband 6cm/headband 8cm

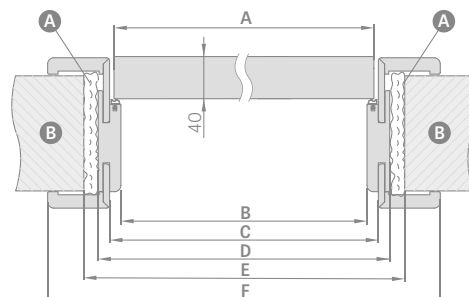

## ADJUSTABLE FRAME ADJUSTMENT RANGE

headband 6cm/headband 8cm

20 or 40mm (for the range 255-295mm)

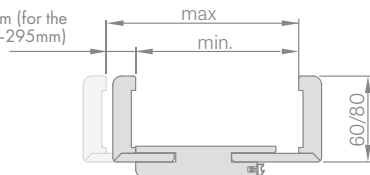

DOOR WIDTH	A	B	C	D	E	F
*60"	644	629	651	673	714	771/811 **
*70"	744	729	751	773	814	871/911 **
*80N <sup>1</sup>	829	805	827	849	888	947/987 **
*80"	844	829	851	873	914	971/1011 **
*90"	944	929	951	973	1014	1071/1111 **
*100"	1044	1029	1051	1073	1114	1171/1211 **
*110"	1144	1129	1151	1173	1214	1271/1311 **

\*headband 6cm/headband 8cm

### Adjustment range min-max (mm)

80-95
95-115
115-135
135-155
155-175
175-195
195-215
215-235
235-255
255-275
275-295
295-335
335-355
355-375
375-395
395-415

1 element

2 elements

## HEIGHT IN PL STANDARD\*

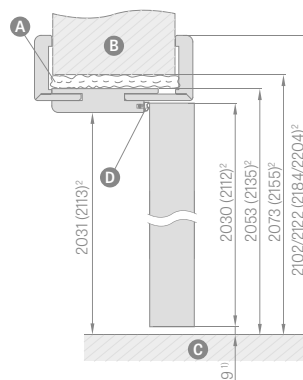

## HEIGHT IN CZ STANDARD\* (-47mm)

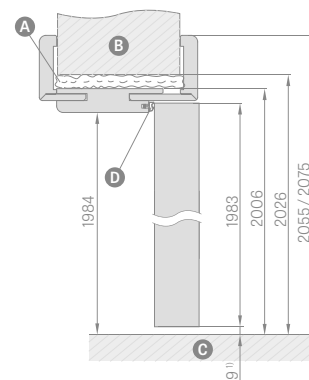

**A** foam **B** wall **C** floor **D** rubber gasket

- Joining at the angle of 90 degrees is possible only in the frame with the architrave 8 cm. 90 degree connection surcharge.
- The door frame with a range exceeding 335 mm consists of two elements.
- Price of the adjustable door frame for double-sash doors +30%.
- 120 mm widening to non-rebated veneered and CPL 0.2 and varnished door frames.
- Replaced with hinges and striker plate in black.

- A movable angle bar with a tongue extended by 2 cm and a standard angle bar for the adjustable door frame, available in all veneers, CPL 0.2 and lacquer.
- Prices for the tunnel door frame with a width of 60, 70, 80, 90, 100 in the price of the adjustable rebated door frame.
- Prices for the tunnel door frame with a width of 110, 120, 130, 140, 150, 160, 170, 180, 190 are included in the price of the adjustable door frame for double-sash rebated doors.
- Non-rebated adjustable door frame in CPL 0.2 is also used in the set for door sashes in CPL 0.7

<sup>1</sup> Permissible deviation resulting from the dimensional tolerance of the door frame ±= 3mm (we recommend checking before installation)

<sup>2</sup> PL2112 standard for a 15% surcharge.

# FRAME FIXED

## REBATED SASHES

### FRAMES FIXED

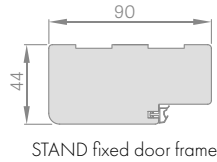

### MASKING BAND

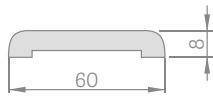

### MASKING BAND 16 mm

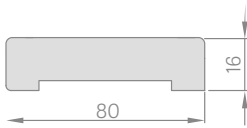

### A QUARTER

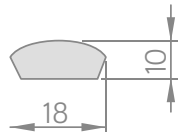

### ANGLE BAR WITH CLIP 6cm and 8cm

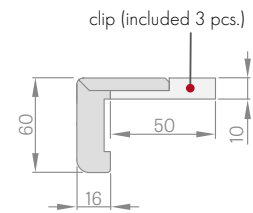
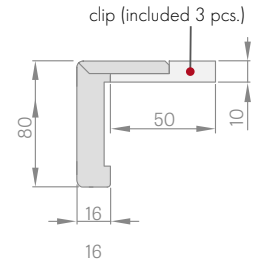

### SCHEME OF THE FIXED STAND AND SOFT DOOR FRAME

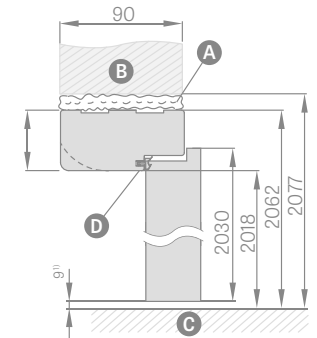
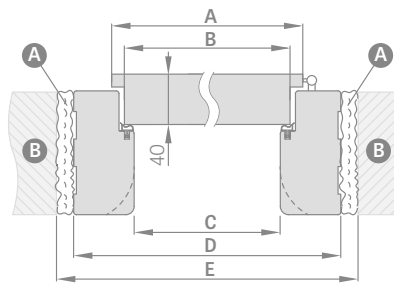

<sup>1)</sup> Permissible deviation resulting from the frame tolerance  $\pm 3$  mm (we recommend checking before installation)

**A** foam    **B** wall    **C** floor    **D** rubber gasket

DOOR WIDTH	A	B	C	D	E
"60"	644	618	604	692	722
"70"	744	718	704	792	822
"80"	844	818	804	892	922
"90"	944	918	904	992	1022
"100"	1044	1018	1004	1092	1122
"110"	1144	1118	1104	1192	1222

- Fixed door frame for double-sash doors + 30%.
- Non-rebated fixed door frame - not available.
- The fixed door frame, the architrave and the angle bar with a clip in CPL 0.2 are also used in the set for door sashes in CPL 0.7.
- Black catch plate available only for the GRAF glass door frame.

# ADJUSTABLE FRAME

REBATED SASHES

FRAME  
**ADJUSTABLE**  
about the area of 320mm



Adjustable door frame with an area range of 320 mm consists of two elements, and the area 400 mm from three elements (they are divided disproportionately).

DIAGRAM  
**ADJUSTABLE FRAME**<sup>headband</sup>  
6cm/headband 8cm

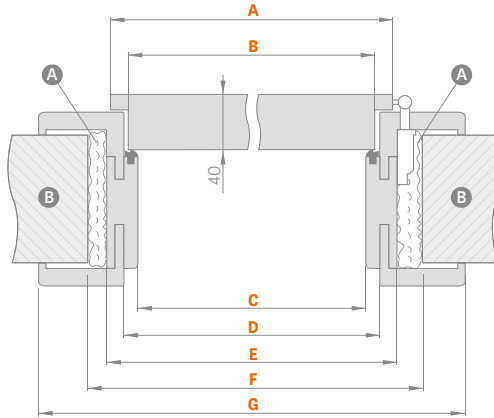

FRAME ADJUSTMENT RANGE  
**ADJUSTABLE**

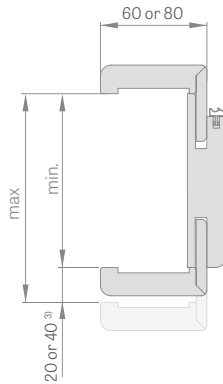

<sup>3)</sup> 40 mm for the range 280-320mm

DOOR WIDTH	A	B	C	D	E	F	G
"60"	644	618	604	626	648	688	746*/786**
"70"	744	718	704	726	748	788	846*/886**
"80"	844	818	804	826	848	888	946*/986**
"90"	944	918	904	926	948	988	1046*/1086**
"100"	1044	1018	1004	1026	1048	1088	1146*/1186**

\*headband 6cm/headband 8cm

HEIGHT IN **PL STANDARD\***

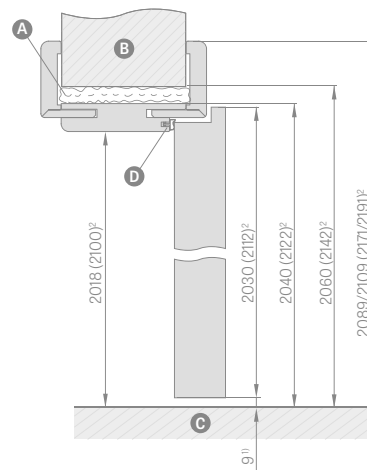

HEIGHT IN **CZ STANDARD\* (-47mm)**

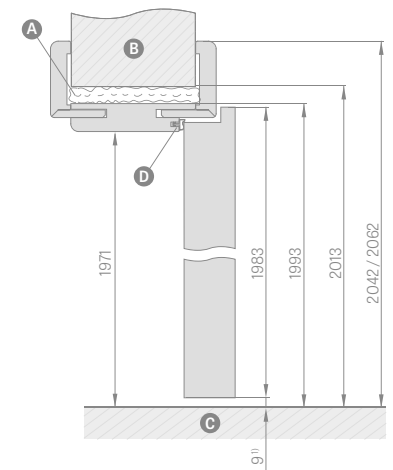

CONNECTION  
**DOOR FRAME**

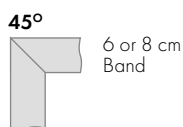
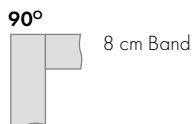

**A** foam    **B** wall    **C** floor    **D** rubber gasket

<sup>1)</sup> Permissible deviation resulting from the dimensional tolerance of the door frame  $\pm 3$  mm (we recommend checking before installation)

<sup>2)</sup> PL2112 standard for a 15% surcharge.

# ADJUSTMENT RANGE

MIN-MAX (MM)











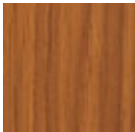
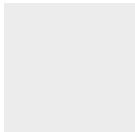

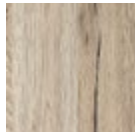
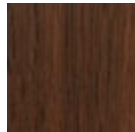
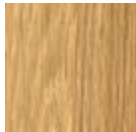
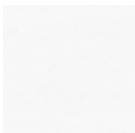
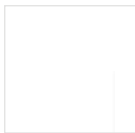

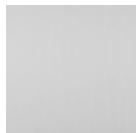

Adjustment range min-max (mm)	
1 element	80-100
	100-120
	120-140
	140-160
	160-180
	180-200
	200-220
	220-240
	240-260
	260-280
	280-320
2 elements	320-340
	340-360
	360-380
	380-400
3 elements	400-420

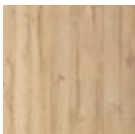
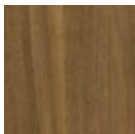
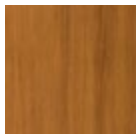
- Joining at the angle of 90 degrees is possible only in the frame with the architrave 8 cm.
- 90 degree connection surcharge.
- Electric strike.
- Reinforcement for door closer.
- Price of a fixed and adjustable door frame for double-sash doors + 30%.
- A movable angle with a tongue extended by 2 cm and a standard angle bar for the adjustable door frame, available in all veneers as well as CPL 0.2 and varnish - applies to the 6 cm and 8 cm architrave solutions.
- 120 mm widening to the adjustable veneered and CPL 0.2 and painted door frame.
- It is possible to make door frames up to the range of 500-520 mm - extra charge for every 2 cm of the range.
- Tunnel frame prices for both rebated and non-rebated door sashes with a width of 60, 70, 80, 90, 100 in the price of an adjustable door frame for rebated door sashes.
- Tunnel frame prices for rebated and non-rebated door sashes with a width of 110, 120, 130, 140, 150, 160, 170, 180, 190 in the price of an adjustable door frame for double-sash rebated doors.
- Door frame in the PL2112 standard +15% to the price of the door frame before EXTRA CHARGE.
- The CPL 0.2 adjustable rebated door frame is also used for the CPL 0.7 sashes.
- Black catch plate available only for the GRAF glass door frame.

# DECORS DRE

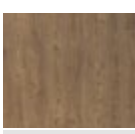
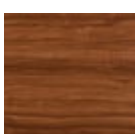

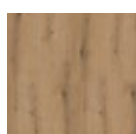
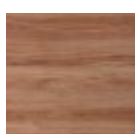
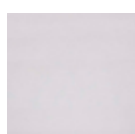





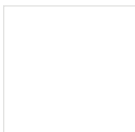
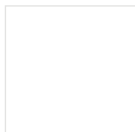
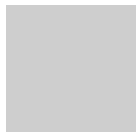

COLORS AVAILABLE ON INTERIOR DOORS

## DRE-CELL DECOR

 golden greko oak	 white greko <sup>1</sup>	 greko elm	 greko gray oak	 sanremo greko	 greco walnut	 greko oak
 white (wood grain structure)	 white matt	 white pine	 silver	 siberian elm	 sand oak	 bleached oak textured
 vintage oak	 caramel walnut	 golden oak textured	 dark walnut textured	 gray oak textured***	 anthracite elm	 dark wenge
 marrone chestnut textured	 walnut	 light gray matt	 evoke oak	 taffee oak***	 gray textured	 black textured

\*\*\*decor only in horizontal graining

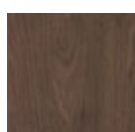
## CPL LAMINATE\*

 white matt	 milky white	 ashen	 dark gray	 concrete 2	 gray oak	 welsh oak
 acacia	 celini walnut	 walnut	 honey oak	 chestnut	 roasted walnut	



**ATTENTION:**  
The sashes in white matt are also available in a non-rebated side-by-side version.

\* laminate available in models 10, 20, 30, 50, 60

## 3D DECOR

 grand oak	 elm	 american walnut	 polish oak 3D
--	--	--	--

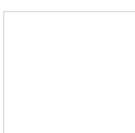
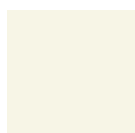
## DECOR

 White	 Ecrú	 Latte	 Ashen
--	---	--	--

white UV acrylic varnish - RAL 9003  
ecru - RAL 9001  
latte - Flugger 4362, NCS S1505-Y50R  
ashen - RAL 7035

# ESTRA

REBATED AND NON-REBATED DOOR SASHES



ESTRA 3, BLACK MAT decor 2, MAT DRE glass pane, CUBE SLIM handle brushed matt chrome

## SOLUTIONS AVAILABLE

**PL**

PL Standard

**SK**

SK Standard

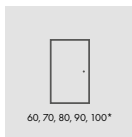

single-sash door

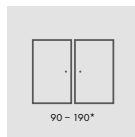

double doors

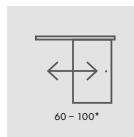

single-sash  
sliding door

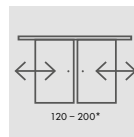

double-sash  
sliding door

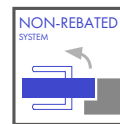

NON-REBATED  
SYSTEM

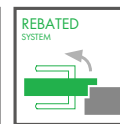

REBATED  
SYSTEM

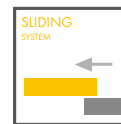

SLIDING  
SYSTEM

## AVAILABLE DOOR SASH WIDTHS

60

70

80

90

100



## IN STANDARD

- Rails and stiles made of wood-based boards
- MAT DRE glass, th. 4mm
- Flat panels th. 16mm

## REBATED DOOR SASH

- Straight edge
- 3 silver screw-in hinges
- lever tumbler lock with a regular key, bathroom lock, cylinder lock or economy lock

## NON-REBATED HINGED DOOR SASH

- Edge without rebate
- sockets for 2 recessed Estetic 80 hinges (hinges are part of the door frame equipment)
- magnetic lock for a regular key, bathroom lock, cylinder lock or economy lockme equipment)

## SLIDING DOOR SASH

- Edge without rebate
- socket for bolt keeper lock and/or handles

### DECOR DRE-CELL



### DECOR 3D

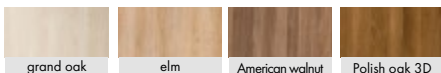

### WITHOUT EXTRA CHARGE

DECORMAT BROWN, DECORMAT GRAPHITE and transparent glass.  
Holes for ventilation sleeves

### WITH EXTRA CHARGE

Plastic ventilation sleeves.  
Non-rebated casement sashes.  
"90" and "100" sash.  
Ventilation undercut.  
Cover strip for non-rebated double-sash doors.  
Double-sash door price x2.  
**NOTE:** the third Estetic 80 hinge for non-rebated doors

\*Door sash width: single sash "60"÷"100", double sash rebated "120" ÷ "200", double sash non-rebated "120" ÷ "180".

# AURI

REBATED AND NON-REBATED DOOR SASHES



AURI 4, EVOKE OAK decor, MAT DRE glass pane, CUBE SLIM black matt door handle

## SOLUTIONS AVAILABLE

**PL**

PL Standard

**SK**

SK Standard

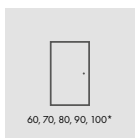

single-sash door

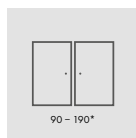

double doors

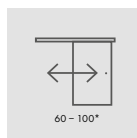

single-sash sliding door

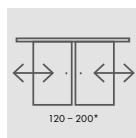

double-sash sliding door

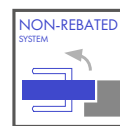

NON-REBATED SYSTEM

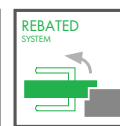

REBATED SYSTEM

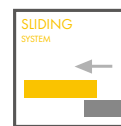

SLIDING SYSTEM

## AVAILABLE DOOR SASH WIDTHS

60

70

80

90

100

## IN STANDARD

- Rails and stiles made of wood-based boards
- MAT DRE glass, th. 4mm
- Flat inserts (AURI 6-8)

## REBATED DOOR SASH

- Straight edge
- 3 silver screw-in hinges
- lever tumbler lock with a regular key, bathroom lock, cylinder lock or economy lock

## NON-REBATED HINGED DOOR SASH

- Edge without rebate
- sockets for 2 recessed Estetic 80 hinges (hinges are part of the door frame equipment)
- magnetic lock for a regular key, bathroom lock, cylinder lock or economy lockme equipment)

## SLIDING DOOR SASH

- Edge without rebate
- socket for bolt keeper lock and/or handles



### DECOR DRE-CELL



### DECOR 3D

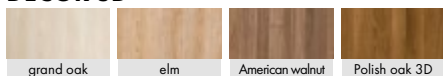

### WITHOUT EXTRA CHARGE

DECORMAT BROWN, DECORMAT GRAPHITE and transparent glass.  
Holes for ventilation sleeves

### WITH EXTRA CHARGE

Plastic ventilation sleeves 1 pc.  
Non-rebated casement sashes.  
"90" and "100" sash.  
Ventilation undercut.  
Cover strip for non-rebated double-sash doors.  
Black VSG 22.1 safety glass unit: models AURI 0 to AURI 8  
Double-sash door price x2.  
**NOTE:** the third Estetic 80 hinge for non-rebated doors (the surcharge is added to the price of the door frame)

\*Door sash width: single sash "60"÷"100", double sash rebated "120" ÷ "200", double sash non-rebated "120" ÷ "180.

# VETRO A

REBATED AND NON-REBATED DOOR SASHES



VETRO 4, WHITE PINE decor, 8mm tempered glass, Cube glossy chrome handle

## SOLUTIONS AVAILABLE

**PL**

PL Standard

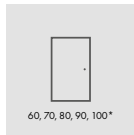

60, 70, 80, 90, 100\*

single-sash door

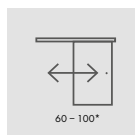

60 - 100\*

single-sash sliding door

The panes from the VETRO collection have an obverse and a reverse (important when juxtaposing doors that open in reverse). The horizontal sections on the right show the arrangement of the glass in the obverse version. When choosing the reverse version, the glass is rotated by 180° around the vertical axis.

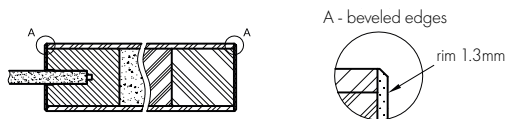

A - beveled edges

rim 1.3mm

### A1-A4, A12-A15 DOOR HORIZONTAL SECTION

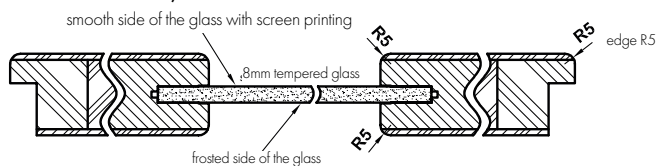

## AVAILABLE DOOR SASH WIDTHS

60 70 80 90 100

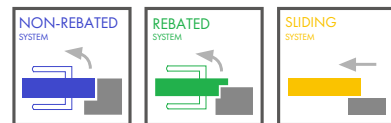

### VENTILATION UNDERCUT

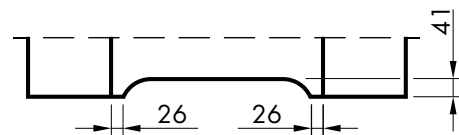

### HORIZONTAL SECTION OF THE VETRO A5, A10-A11 DOOR

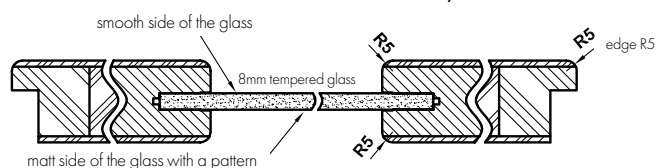

## IN STANDARD

- Reinforced MDF frame.
- Filling perforated chipboard.
- Tempered glass th. 8mm

## REBATED DOOR SASH

- Edge R5.
- 3 silver screw-in hinges.
- lever tumbler lock with a regular key, bathroom lock, cylinder lock or economy lock

## NON-REBATED HINGED SASH - ONLY WHITE MATT

- Edge without rebate
- sockets for 2 recessed Estetic 80 hinges (hinges are part of the door frame equipment)
- magnetic lock for a regular key, bathroom lock, cylinder lock or economy lockme equipment)

## SLIDING DOOR SASH

- Edge without rebate
- socket for bolt keeper lock and/or handles

**NOTE:** VETRO A door sashes in the sliding version do not fit sliding system with a PA frame cassette.

Sashes cannot be shortened.

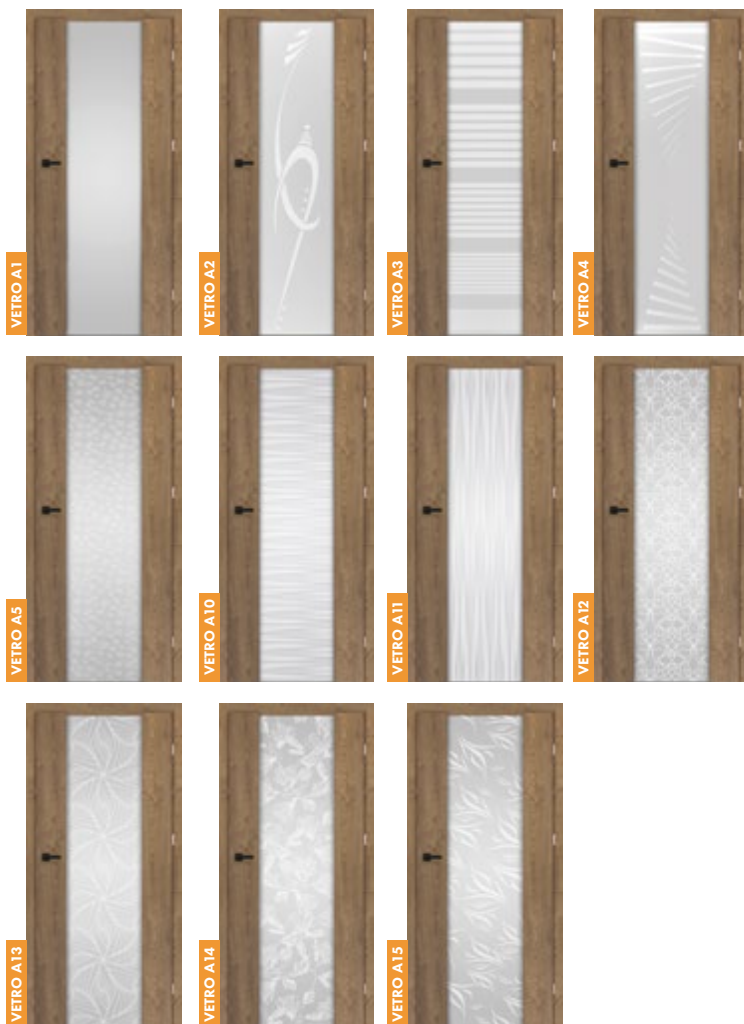

### DECOR DRE-CELL

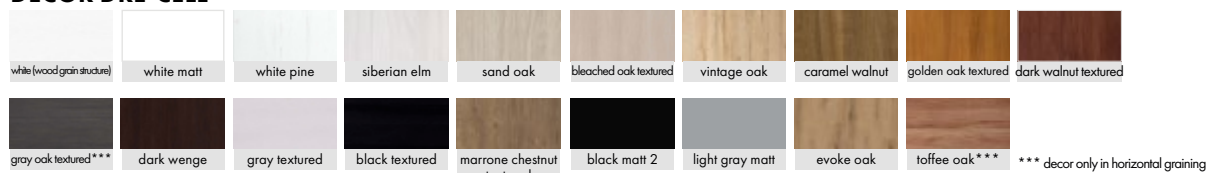

### DECOR 3D

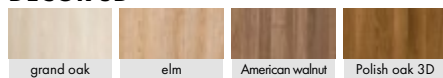

**NOTE:** The sashes in white matt are also available in a non-rebated side-by-side version.

### WITHOUT EXTRA CHARGE

Possibility of making a ventilation undercut (A).

A sash with a glass in the reverse arrangement.

VETRO A1 four types of glass to choose from: DECORMAT, DECORMAT BROWN, DECORMAT GRAPHITE and transparent glass.

### WITH EXTRA CHARGE

Non-rebated casement sashes.

**NOTE:** the third Estetic 80 hinge for non-rebated doors (the surcharge is added to the price of the door frame).

# VETRO B

REBATED AND NON-REBATED DOOR SASHES



VETRO B 11, BLACK STRUCTURE decor, 8mm tempered glass, LUNA PREMIUM SQUARE door handle brushed chrome matt

## SOLUTIONS AVAILABLE

PL

PL Standard



60, 70, 80, 90, 100\*

single-sash door

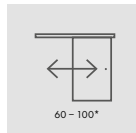

60 - 100\*

single-sash sliding door

SK

SK Standard

The panes from the VETRO collection have an obverse and a reverse (important when juxtaposing doors that open in reverse). The horizontal sections on the right show the arrangement of the glass in the obverse version. When choosing the reverse version, the glass is rotated by 180° around the vertical axis.

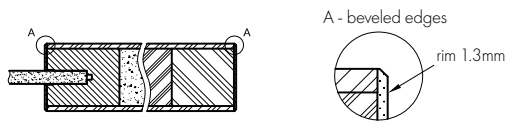

### B1-B4, B12-B15 DOOR HORIZONTAL SECTION

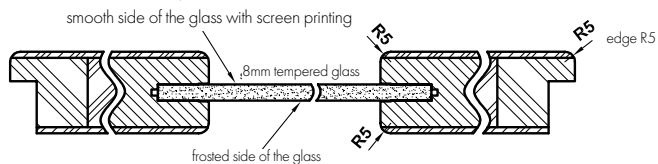

## AVAILABLE DOOR SASH WIDTHS

60 70 80 90 100

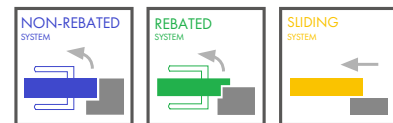

## VENTILATION UNDERCUT

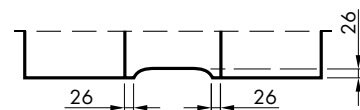

### B5, B10-B11 HORIZONTAL SECTION OF THE VETRO

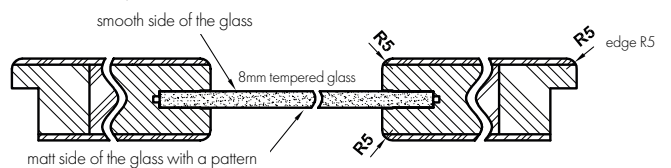

## IN STANDARD

- Reinforced MDF frame.
- Filling perforated chipboard.
- Tempered glass th. 8mm

## REBATED DOOR SASH

- Edge R5.
- 3 silver screw-in hinges.
- lever tumbler lock with a regular key, bathroom lock, cylinder lock or economy lock

## NON-REBATED HINGED SASH - ONLY WHITE MATT

- Edge without rebate
- sockets for 2 recessed Estetic 80 hinges (hinges are part of the door frame equipment)
- magnetic lock for a regular key, bathroom lock, cylinder lock or economy lockme equipment)

## SLIDING DOOR SASH

- Edge without rebate
- socket for bolt keeper lock and/or handles

**NOTE:** VETRO B wings of width "70" are not suitable for the following systems sliding system with the PA frame cassette.

No possibility of shortening wings.

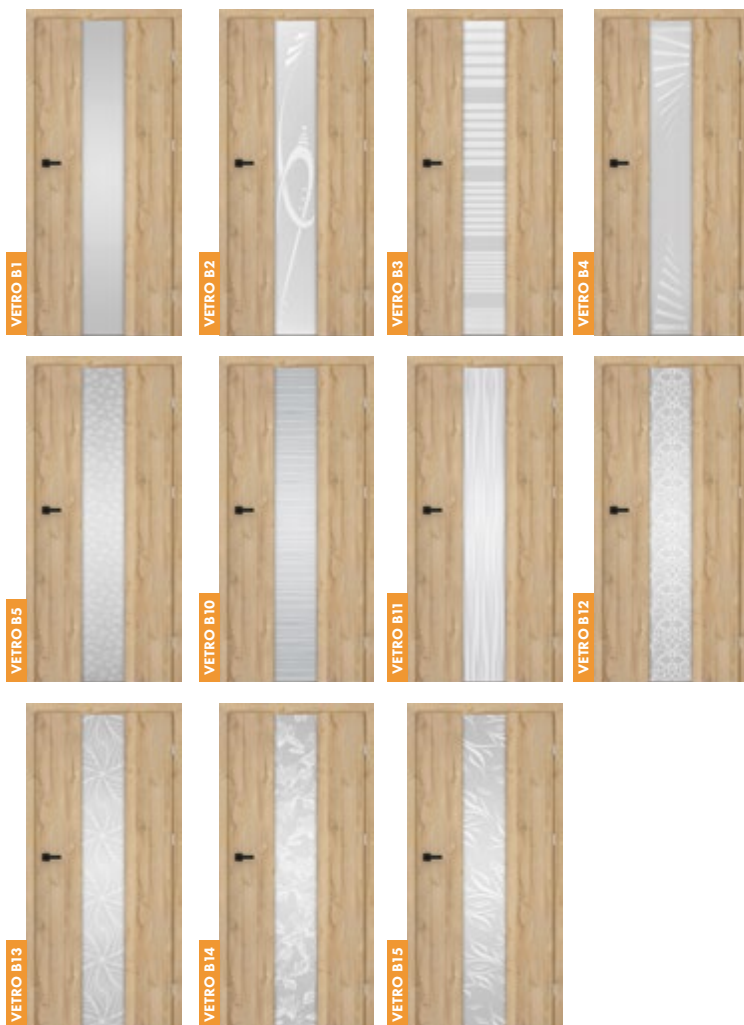

### DECOR DRE-CELL

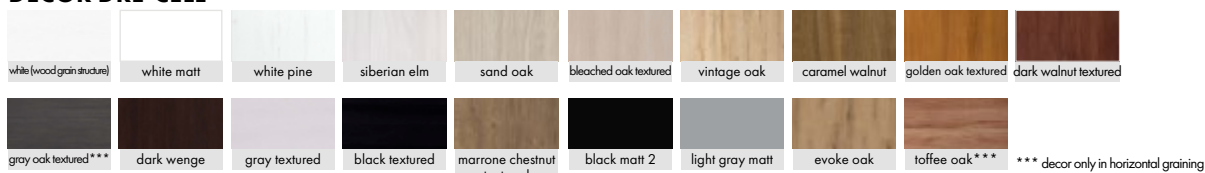

### DECOR 3D

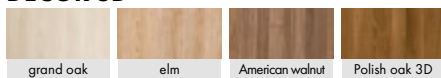

**NOTE:** The sashes in white matt are also available in a non-rebated side-by-side version.

### WITHOUT EXTRA CHARGE

Possibility of making a ventilation undercut (B).

A sash with a glass in the reverse arrangement.

VETRO B1 four types of glass to choose from: DECORMAT, DECORMAT BROWN, DECORMAT GRAPHITE and transparent glass.

### WITH EXTRA CHARGE

Non-rebated casement sashes.

**NOTE:** the third Estetic 80 hinge for non-rebated doors (the surcharge is added to the price of the door frame).

# VETRO D

REBATED AND NON-REBATED DOOR SASHES



VETRO D1, WHITE MAT decor, black tempered laminated glass, TOPAZ black matt door handle

## SOLUTIONS AVAILABLE

PL

PL Standard

SK

SK Standard

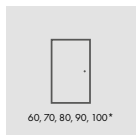

single-sash door

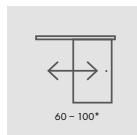

single-sash sliding door

The panes from the VETRO collection have an obverse and a reverse (important when juxtaposing doors that open in reverse). The horizontal sections on the right show the arrangement of the glass in the obverse version. When choosing the reverse version, the glass is rotated by 180° around the vertical axis.

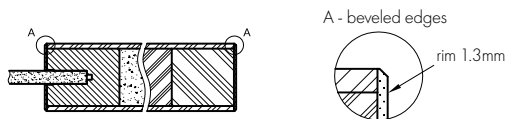

## VETRO D1 DOOR HORIZONTAL SECTION

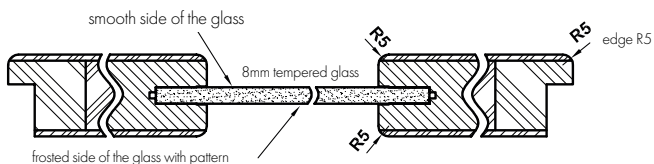

## AVAILABLE DOOR SASH WIDTHS

60 70 80 90 100

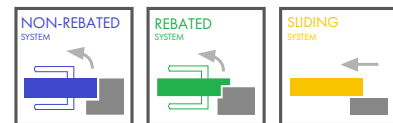

## VENTILATION UNDERCUT

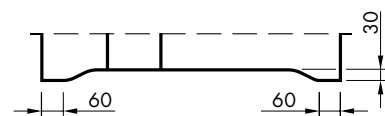



## IN STANDARD

- Reinforced MDF frame: narrow element with fixed width, wide element with variable width.
- Filling perforated chipboard.
- Tempered glass th. 8 mm with a fixed width (regardless of the door sash width).

## REBATED DOOR SASH

- Edge R5.
- 3 silver screw-in hinges.
- Lever tumbler lock with a regular key, bathroom lock, cylinder lock or economy lock.

## NON-REBATED HINGED SASH - ONLY WHITE MATT

- Edge without rebate.
- Sockets for 2 recessed Estetic 80 hinges (hinges are part of the door frame equipment).
- Magnetic lock for a regular key, bathroom lock, cylinder lock or economy lockme equipment).

## SLIDING DOOR SASH

- Edge without rebate.
- Socket for bolt keeper lock and/or handles.

**NOTE:** VETRO D sliding sashes are not compatible with the sliding system with the PA frame cassette.

No possibility of shortening wings.

### DECOR DRE-CELL

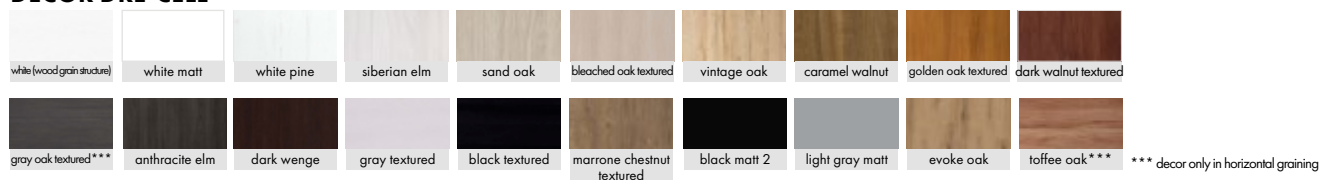

### DECOR 3D



**NOTE:** The sashes in white matt are also available in a non-rebated side-by-side version.

### WITHOUT EXTRA CHARGE

A sash with a glass in the reverse arrangement.

### WITH EXTRA CHARGE

Ventilation undercut.

Black tempered laminated glass.

Non-rebated door sashes only white matt.

**NOTE:** the third Estetic 80 hinge for non-rebated doors (the surcharge is added to the price of the door frame).

# NOVA

REBATED AND NON-REBATED DOOR SASHES



NOVA 10, CONCRETE OXIDE decor, BLACK MAT 2 door frame, QUBE black matt door handle

## SOLUTIONS AVAILABLE

PL

PL Standard

SK

SK Standard

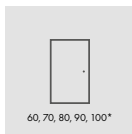

single-sash door

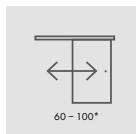

single-sash  
sliding door

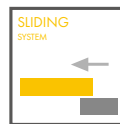
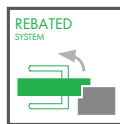
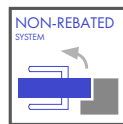

## AVAILABLE DOOR SASH WIDTHS

60

70

80

90

100

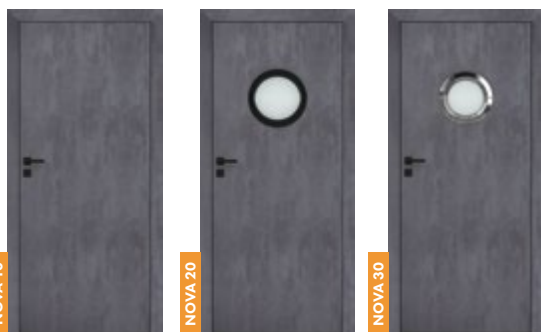

NOVA 10

NOVA 20

NOVA 30



NOVA 40

### WITH EXTRA CHARGE

Model options to choose from:

NOVA 10 - full sash, no glazing

NOVA 20 - MDF porthole

NOVA 30 - metal porthole (matt or transparent glass)

NOVA 40 - MDF frame in black mat foil

NOVA 30 metal PORTHOLE - steel or black.

Only matt or transparent glass available.

## IN STANDARD

- Softwood frame.
- Honeycomb filling.
- MAT DRE glass, th. 4mm.
- Edging in black.

## REBATED DOOR SASH

- Straight edge.
- 2 silver screw-in hinges.
- A lever tumbler lock in silver for a regular key, a bathroom lock, a cylinder lock or a mortise lock.

## NON-REBATED DOOR SASH TURN SASH

- Edge without rebate.
- Sockets for 2 recessed Estetic 80 hinges (hinges are part of the door frame equipment).
- Magnetic lock for a regular key, bathroom lock, cylinder lock or economy lock in black.

## SLIDING DOOR SASH

- Edge without rebate.
- Socket for bolt keeper lock and/or handles.

## DOOR FRAMES

- For door sashes from the NOVA collection, we recommend door frames in the colour of the foil or DRE-CELL black mat 2.

**NOTE:** VETRO D sliding sashes are not compatible with the sliding system with the PA frame cassette.

No possibility of shortening wings.

### DECOR

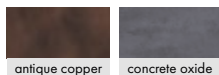

antique copper

concrete oxide

### WITHOUT EXTRA CHARGE

Ventilation sleeves.

The third hinge for the REBATED DOOR Sash

DECORMAT BROWN, DECORMAT GRAPHITE and transparent glass

### WITH EXTRA CHARGE

Filling perforated chipboard.

Non-rebated casement sashes.

Sashes „90“, „100“.

Ventilation undercut.

Plastic ventilation grille.

Aluminium ventilation grille.

**NOTE:** the third Estetic 80 hinge for non-rebated doors. (the surcharge is added to the price of the door frame)

\*Door sash width: single sash "60"÷"100".

# GALERIA ALU

REBATED AND NON-REBATED DOOR SASHES



GALERIA ALU 20, BLACK STRUCTURE decor, CUBE SLIM door handle brushed chrome

## SOLUTIONS AVAILABLE

**PL**

PL Standard

**SK**

SK Standard

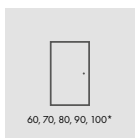

single-sash door

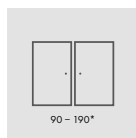

double doors

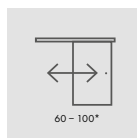

single-sash sliding door

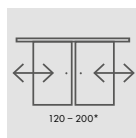

double-sash sliding door

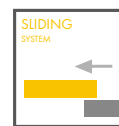
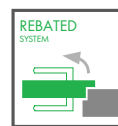
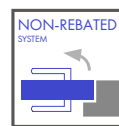

## AVAILABLE DOOR SASH WIDTHS

60

70

80

90

100

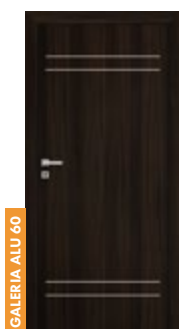
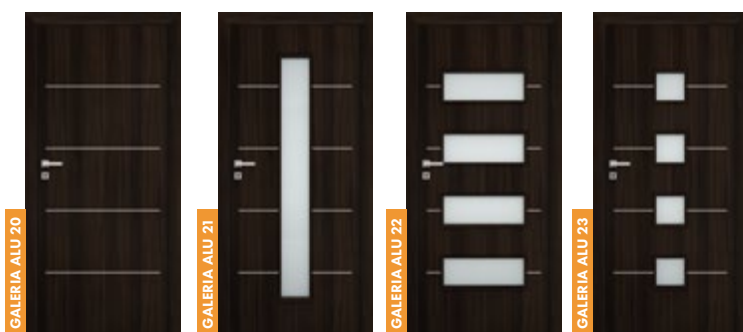

## IN STANDARD

- Softwood frame.
- Filling perforated chipboard.
- Edge radius R 2.5 mm for CPL laminatees, th. 0.15-0.2mm.
- Decorative inserts 8 mm.
- Glass MAT DRE.

## REBATED DOOR SASH

- Straight edge, flat glazing frame
- 2 silver screw-in hinges.
- Lever tumbler lock with a regular key, bathroom lock, cylinder lock or economy lock
- Straight edge or edge with radius R 2.5 mm made by direct forming (in CPL laminatee).

## NON-REBATED HINGED SASH

- Edge without rebate, flat glazing frame.
- Sockets for 2 recessed Estetic 80 hinges (hinges are part of the door frame equipment).
- Magnetic lock for a regular key, bathroom lock, cylinder lock or economy lockme equipment).

## SLIDING DOOR SASH

- Edge without rebate, flat glazing frame.
- Socket for bolt keeper lock and/or handles.

### DECOR DRE-CELL

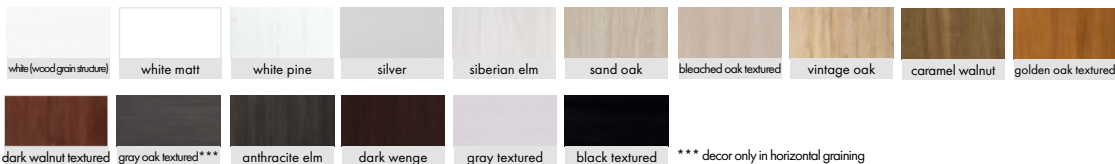

### DECOR 3D



### LAMINATE CPL\*

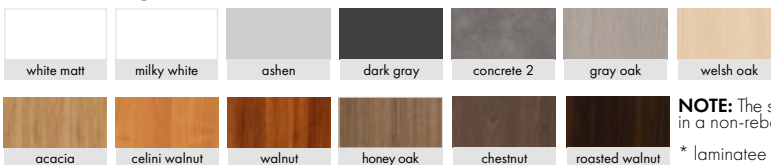

**NOTE:** The sashes in white matt are also available in a non-rebated side-by-side version.

\* laminatee available in models 10, 20, 30, 50, 60

### WITHOUT EXTRA CHARGE

Glass DECORMAT BROWN, DECORMAT GRAPHITE, chinchilla, blind, white bark, th. 4mm.

Ventilation sleeves.

The third hinge for the REBATED DOOR Sash.

### WITH EXTRA CHARGE

VSG 22.1 frosted safety glass unit.

Non-rebated casement sashes.

Sashes „90“, „100“.

Ventilation undercut.

Plastic ventilation grille.

Aluminium ventilation grille.

Cover strip for non-rebated double-sash doors

Double-sash door price x 2.

**NOTE:** the third Estetic 80 hinge for non-rebated doors. (the surcharge is added to the price of the door frame)

\*Door sash width: single sash "60"÷"100", double sash rebated "120" ÷ "200", double sash non-rebated "120" ÷ "180".

# UNI

REBATED AND NON-REBATED DOOR SASHES



UNI, ECRU decor, metal porthole, MAT DRE glass, CUBE glossy chrome handle

## SOLUTIONS AVAILABLE

**PL**

PL Standard

**SK**

SK Standard

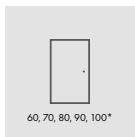

single-sash door

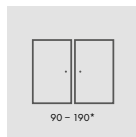

double doors

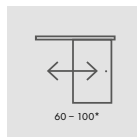

single-sash sliding door

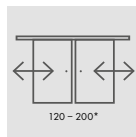

double-sash sliding door

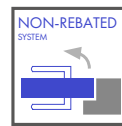

NON-REBATED SYSTEM

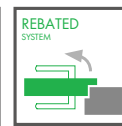

REBATED SYSTEM

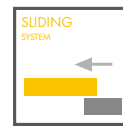

SLIDING SYSTEM

### AVAILABLE DOOR SASH WIDTHS

60

70

80

90

100



Black metal porthole



Metal porthole

Only matt or transparent glass available



## IN STANDARD

- The sash is painted with UV acrylic varnish.
- MDF board frame.
- Honeycomb filling.
- Glass MAT DRE.

**NOTE:** In order to ensure high quality of painted products, both door sashes and frames are covered with a special material constituting a uniform base before painting.

## REBATED DOOR SASH

- Straight edge.
- 2 silver screw-in hinges.
- A lever tumbler lock in silver for a regular key, a bathroom lock, a cylinder lock or a mortise lock.

## NON-REBATED DOOR SASH TURN SASH

- Edge without rebate.
- Sockets for 2 recessed Estetic 80 hinges (hinges are part of the door frame equipment).
- Magnetic lock for a regular key, bathroom lock, cylinder lock or economy lockme equipment) in your choice of steel, black or white.

## SLIDING DOOR SASH

- Edge without rebate.
- Socket for bolt keeper lock and/or handles.

## INVERTED REBATE DOOR SASH

- Active turn single-sash
- Straight edge.
- Sockets for 2 recessed hinges Estetic 1821 (hinges are part of the door frame equipment).
- Magnetic lock for a regular key, bathroom lock, cylinder lock or economy lock.

### DECOR



white UV acrylic varnish - RAL 9003  
 ecrú - RAL 9001  
 latte - Flugger 4362, NCS S1505-Y50R  
 ashén - RAL 7035

### WITHOUT EXTRA CHARGE

Glass DECORMAT BROWN, DECORMAT GRAPHITE, chinchilla, blind, white bark

Ventilation sleeves.

Third hinge for rebate sash.

### WITH EXTRA CHARGE

Frosted glass VSG 22.1 combined safe MDF PORTHOLE.

Filling perforated chipboard.

Full chipboard filling.

"90" and "100" sash.

Ventilation undercut.

Non-rebated casement sashes.

Sashes with inverted rebate.

Cover strip for non-rebated double-sash doors.

Plastic ventilation grille.

Aluminium ventilation grille.

Double-sash door price x2.

**NOTE:** the third Estetic 80 hinge for non-rebated doors. (the surcharge is added to the price of the door frame).

\*Door sash width: single sash "60"÷"100", double sash rebated "120" ÷ "200", double sash non-rebated "120" ÷ "180".

# FARGO

REBATED AND NON-REBATED DOOR SASHES



FARGO 10, gray decor, Cube handle brushed matt chrome

## SOLUTIONS AVAILABLE

**PL**

PL Standard

**SK**

SK Standard

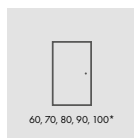

single-sash door

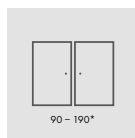

double doors

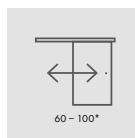

single-sash  
sliding door

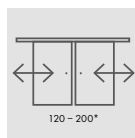

double-sash  
sliding door

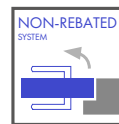

NON-REBATED  
SYSTEM

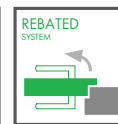

REBATED  
SYSTEM

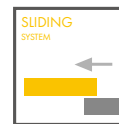

SLIDING  
SYSTEM

## AVAILABLE DOOR SASH WIDTHS

60

70

80

90

100



Milling type



## IN STANDARD

- The sash is painted with UV acrylic varnish.
- MDF board frame.
- Honeycomb filling.

**NOTE:** NOTE: In order to ensure high quality of painted products, both door sashes and frames are covered with a special material constituting a uniform base before painting.

## REBATED DOOR SASH

- Straight edge.
- 2 silver screw-in hinges.
- A lever tumbler lock in silver for a regular key, a bathroom lock, a cylinder lock or a mortise lock.

## NON-REBATED DOOR SASH TURN SASH

- Edge without rebate.
- Sockets for 2 recessed Estetic 80 hinges (hinges are part of the door frame equipment).
- Magnetic lock for a regular key, bathroom lock, cylinder lock or economy lockme equipment) in your choice of steel, black or white.

## SLIDING DOOR SASH

- Edge without rebate.
- Socket for bolt keeper lock and/or handles.

## INVERTED REBATE DOOR SASH

- Active turn single-sash
- Straight edge.
- Sockets for 2 recessed hinges Estetic 1821 (hinges are part of the door frame equipment).
- Magnetic lock for a regular key, bathroom lock, cylinder lock or economy lock.

### DECOR



white UV acrylic varnish - RAL 9003  
 ecrú - RAL 9001  
 latte - Flugger 4362, NCS S1505-Y50R  
 ashen - RAL 7035

### WITHOUT EXTRA CHARGE

Ventilation sleeves.  
 The third hinge for the REBATED DOOR Sash.

### WITH EXTRA CHARGE

Filling perforated chipboard.  
 Full chipboard filling.  
 "90" and "100" sash.  
 Ventilation undercut.  
 Non-rebated casement sashes.  
 Sashes with inverted rebate.

Cover strip for non-rebated double-sash doors.  
 Plastic ventilation grille.  
 Aluminium ventilation grille.  
 Double-sash door price x2.

**NOTE:** the third Estetic 80 hinge for non-rebated doors. (the surcharge is added to the price of the door frame).

# BINITO

REBATED AND NON-REBATED DOOR SASHES



BINITO 20, Apollo black handle

## SOLUTIONS AVAILABLE

**PL**

PL Standard

**SK**

SK Standard

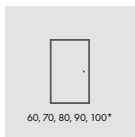

single-sash door

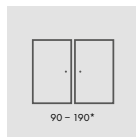

double doors

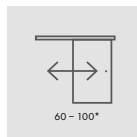

single-sash sliding door

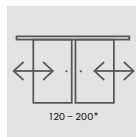

double-sash sliding door

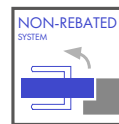

NON-REBATED SYSTEM

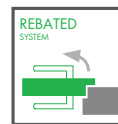

REBATED SYSTEM

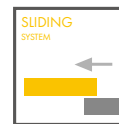

SLIDING SYSTEM

## AVAILABLE DOOR SASH WIDTHS

60

70

80

90

100



Milling type



## IN STANDARD

- The sash is painted with UV acrylic varnish.
- MDF board frame.
- Honeycomb filling.
- Glass MAT DRE.

**NOTE:** NOTE: In order to ensure high quality of painted products, both door sashes and frames are covered with a special material constituting a uniform base before painting.



## REBATED DOOR SASH

- Straight edge.
- 2 silver screw-in hinges.
- A lever tumbler lock in silver for a regular key, a bathroom lock, a cylinder lock or a mortise lock.



## NON-REBATED DOOR SASH TURN SASH

- Edge without rebate.
- Sockets for 2 recessed Estetic 80 hinges (hinges are part of the door frame equipment).
- Magnetic lock for a regular key, bathroom lock, cylinder lock or economy lockme equipment) in your choice of steel, black or white.



### DECOR

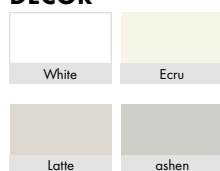

white UV acrylic varnish - RAL 9003  
 ecru - RAL 9001  
 latte - Flügler 4362, NCS S 1505-Y50R  
 ashen - RAL 7035

## SLIDING DOOR SASH

- Edge without rebate.
- Socket for bolt keeper lock and/or handles.

## INVERTED REBATE DOOR SASH

- Active turn single-sash
- Straight edge.
- Sockets for 2 recessed hinges Estetic 1821 (hinges are part of the door frame equipment).
- Magnetic lock for a regular key, bathroom lock, cylinder lock or economy lockme equipment).

### WITHOUT EXTRA CHARGE

DECORMAT BROWN, DECORMAT GRAPHITE, chinchilla, blinds, white bark.

Ventilation sleeves.

The third hinge for the REBATED DOOR Sash.

### WITH EXTRA CHARGE

Frosted VSG 22.1 glass unit safe for models: BINITO 11, 23, 21, 24, 100, 110.

Filling perforated chipboard.

Full chipboard filling.

"90" and "100" sash.

Ventilation undercut.

Non-rebated casement sashes.

Sashes with inverted rebate.

Cover strip for non-rebated double-sash doors.

Plastic ventilation grille.

Aluminium ventilation grille.

Double-sash door price x2.

**NOTE:** the third Estetic 80 hinge for non-rebated doors. (the surcharge is added to the price of the door frame).

# STANDARD

REBATED AND NON-REBATED DOOR SASHES



STANDARD 10, EVOKE OAK decor door sash, black structure door frame, black matt CUBE door handle

## SOLUTIONS AVAILABLE

**PL**

PL Standard

**SK**

SK Standard

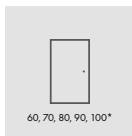

60, 70, 80, 90, 100\*

single-sash door

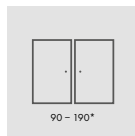

90 - 190\*

double doors

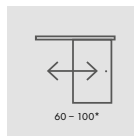

60 - 100\*

single-sash  
sliding door

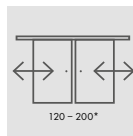

120 - 200\*

double-sash  
sliding door

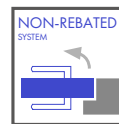

NON-REBATED  
SYSTEM

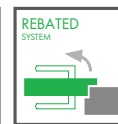

REBATED  
SYSTEM

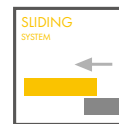

SLIDING  
SYSTEM

## AVAILABLE DOOR SASH WIDTHS

60

70

80

90

100

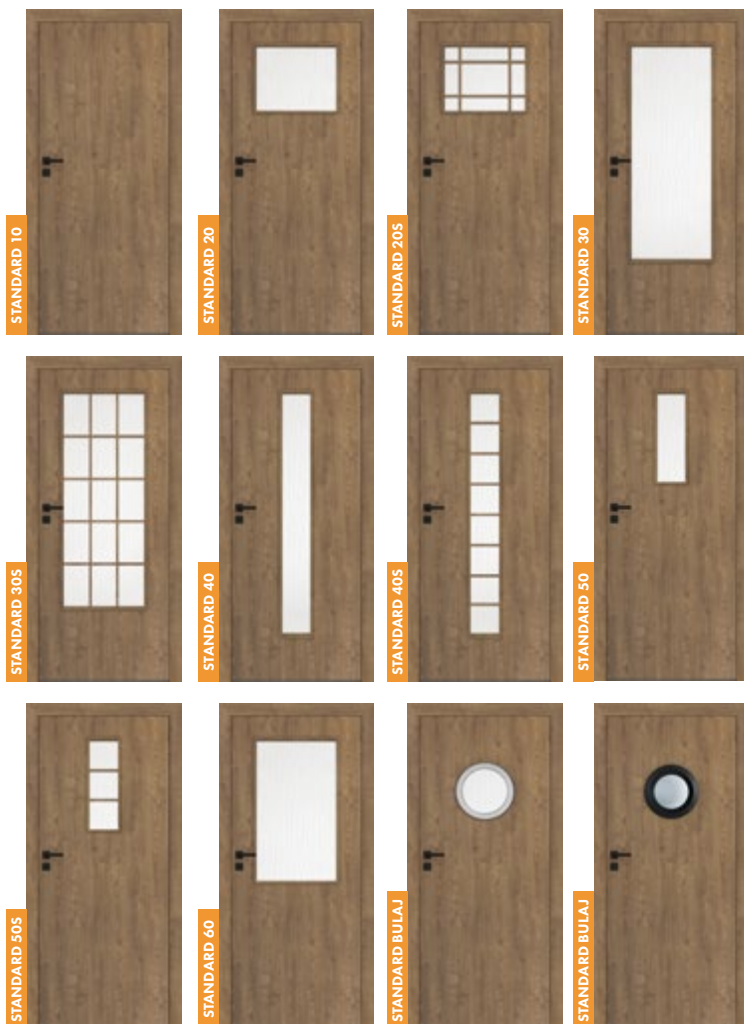

## IN STANDARD

- Softwood frame.
- Honeycomb filling.
- Glass MAT DRE.

## REBATED DOOR SASH

- Straight edge, flat glazing frame
- 2 silver screw-in hinges.
- Lever tumbler lock with a regular key, bathroom lock, cylinder lock or economy lock.

## NON-REBATED HINGED SASH

- Edge without rebate, flat glazing frame.
- Sockets for 2 recessed Estetic 80 hinges (hinges are part of the door frame equipment).
- Magnetic lock for a regular key, bathroom lock, cylinder lock or economy lockme equipment).

## SLIDING DOOR SASH

- Edge without rebate and to choose from: flat or rounded glazing bar.
- Socket for bolt keeper lock and/or handles.

### DECOR DRE-CELL

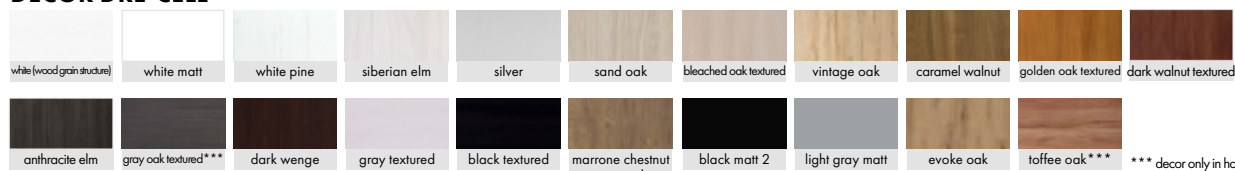

### DECOR 3D

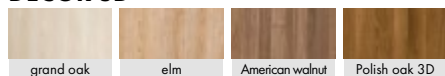

### WITHOUT EXTRA CHARGE

Ventilation sleeves.

The third hinge for the REBATED DOOR Sash.

DECORMAT BROWN, DECORMAT GRAPHITE, chinchilla, blinds, white bark.

\*Door sash width: single sash "60"÷"100", double sash rebated "120" ÷ "200", double sash non-rebated "120" ÷ "180.

### WITH EXTRA CHARGE

Frosted VSG 22.1 glass unit safe for models: STANDARD 20, 20s, 30, 30s, 40, 40s, 50, 50s, 60, BULAJ MDF

Filling perforated chipboard.

Non-rebated casement sashes.

"90" and "100" sash.

Ventilation undercut.

Plastic ventilation grille.

Aluminium ventilation grille.

Cover strip for non-rebated double-sash doors.

Double-sash door price x2.

**NOTE:** the third Estetic 80 hinge for non-rebated doors (the surcharge is added to the price of the door frame).

# MODERN

REBATED AND NON-REBATED DOOR SASHES



MODERN 30 with a black SLIM frame, American walnut decor, black matt cube handle

## SOLUTIONS AVAILABLE

**PL**

PL Standard

**SK**

SK Standard

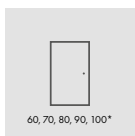

single-sash door

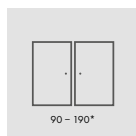

double doors

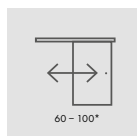

single-sash  
sliding door

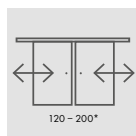

double-sash  
sliding door

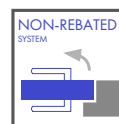

NON-REBATED  
SYSTEM

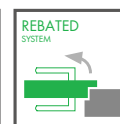

REBATED  
SYSTEM

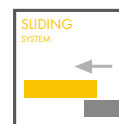

SLIDING  
SYSTEM

## AVAILABLE DOOR SASH WIDTHS

60

70

80

90

100



## IN STANDARD

- Softwood frame.
- Honeycomb filling.
- Glass MAT DRE.

## REBATED DOOR SASH

- Straight edge, flat glazing bar in the door sash decor, flat HDF panels, th. 4mm.
- 2 silver screw-in hinges.
- A lever tumbler lock in silver for a regular key, a bathroom lock, a cylinder lock or a mortise lock.

## NON-REBATED DOOR SASH TURN SASH

- edge without rebate, flat glazing bar in the sash decor, flat HDF panels, th. 4mm.
- Sockets for 2 recessed Estetic 80 hinges (hinges are part of the door frame equipment).
- Magnetic lock for a regular key, bathroom lock, cylinder lock or economy lockme equipment).

## SLIDING DOOR SASH

- Edge without rebate and of choice: flat glazing frame in door sash decor or black Slim, flat HDF 4mm panels.

### DECOR DRE-CELL

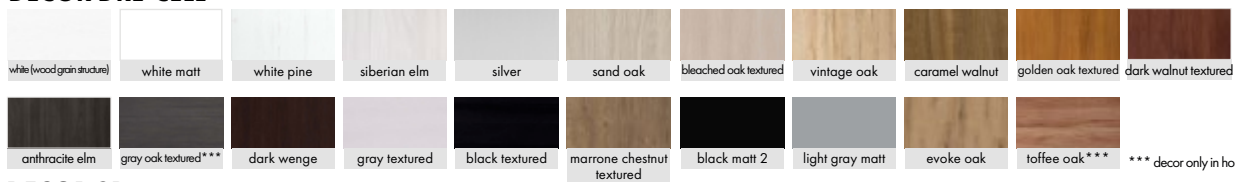

### DECOR 3D

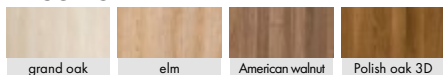

### WITHOUT EXTRA CHARGE

DECORMAT BROWN, DECORMAT GRAPHITE, chinchilla, blinds, white bark.

Ventilation sleeves.

The third hinge for the REBATED DOOR Sash.

### WITH EXTRA CHARGE

Frosted VSG 22.1 glass unit safe for models: MODERN 20, 30, 40, 50.

Filling perforated chipboard.

Non-rebated casement sashes.

"90" and "100" sash.

Ventilation undercut.

Plastic ventilation grille.

Aluminium ventilation grille.

Double-sash door price x2.

**NOTE:** the third Estetic 80 hinge for non-rebated doors. (the surcharge is added to the price of the door frame).

\*Door sash width: single sash "60"÷"100", double sash rebated "120" ÷ "200", double sash non-rebated "120" ÷ "180".

# PLUS

REBATED AND NON-REBATED DOOR SASHES



PLUS 30, white matt decor, Cube handle brushed matt chrome

## SOLUTIONS AVAILABLE

**PL**

PL Standard

**SK**

SK Standard

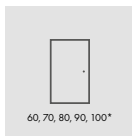

single-sash door

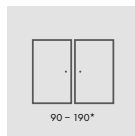

double doors

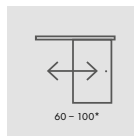

single-sash sliding door

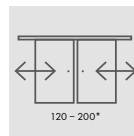

double-sash sliding door

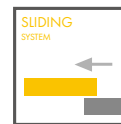
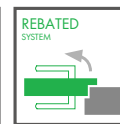
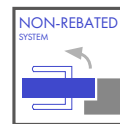

## AVAILABLE DOOR SASH WIDTHS

60

70

80

90

100



## IN STANDARD

- Softwood frame.
- Honeycomb filling.
- Glass MAT DRE.

## REBATED DOOR SASH

- Straight edge, flat glazing bar in the door sash decor, flat HDF panels, th. 4mm.
- 2 silver screw-in hinges.
- A lever tumbler lock in silver for a regular key, a bathroom lock, a cylinder lock or a mortise lock.

## NON-REBATED DOOR SASH TURN SASH

- edge without rebate, flat glazing bar in the sash decor, flat HDF panels, th. 4mm.
- Sockets for 2 recessed Estetic 80 hinges (hinges are part of the door frame equipment).
- Magnetic lock for a regular key, bathroom lock, cylinder lock or economy lockme equipment).

## SLIDING DOOR SASH

- Edge without rebate and to choose from: flat glazing bar in the door sash decor, flat HDF panels, th. 4mm.
- Socket for bolt keeper lock and/or handles.

### DECOR DRE-CELL

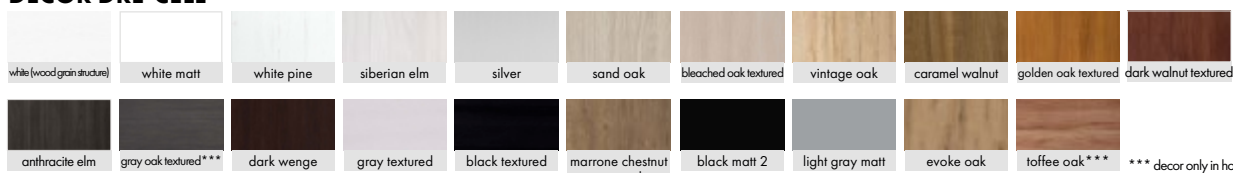

### DECOR 3D

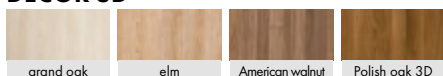

### WITHOUT EXTRA CHARGE

DECORMAT BROWN, DECORMAT GRAPHITE, chinchilla, blinds, white bark.

Ventilation sleeves.

The third hinge for the REBATED DOOR Sash.

### WITH EXTRA CHARGE

Frosted VSG 22.1 glass unit safe for models: PLUS 20, 30, 40, 50, 60, 70, 80.

Filling perforated chipboard.

Non-rebated casement sashes.

"90" and "100" sash.

Ventilation undercut.

Plastic ventilation grille.

Aluminium ventilation grille.

Cover strip for non-rebated double-sash doors.

Double-sash door price x2.

**NOTE:** the third Estetic 80 hinge for non-rebated doors. (the surcharge is added to the price of the door frame).

\*Door sash width: single sash "60"÷"100", double sash rebated "120" ÷ "200", double sash non-rebated "120" ÷ "180.

# STANDARD 10

DOORS WITH VARIABLE HEIGHTS



## IN STANDARD

- Softwood frame.
- Honeycomb filling.

## REBATED DOOR SASH

- Straight edge covered with edging or an edge with a radius of R 2.5 mm made by direct forming.
- 3 silver screw-in hinges.
- Lever tumbler lock with a regular key, bathroom lock, cylinder lock or economy lock.

## NON-REBATED HINGED DOOR SASH

- Edge without rebate.
- Sockets for 2 recessed Estetic 80 hinges (hinges are part of the door frame equipment).
- Magnetic lock for a regular key, bathroom lock, cylinder lock or economy lockme equipment).

## WITHOUT EXTRA CHARGE

Ventilation sleeves.

## WITH EXTRA CHARGE

Filling:

Perforated chipboard (1983)

Perforated chipboard (2110 i 2240)

Sashes „90“-„100“ (1983) DRE - CELL

Sashes „90“-„100“ (2110 i 2240) DRE - CELL

Sashes „100“ (1983) DRE - CPL

Sashes „100“ (2110 i 2240) DRE - CPL

Non-rebated turn sashes

Ventilation undercut

Plastic ventilation grille

Aluminium ventilation grille

Cover strip for non-rebated double-sash doors

Double-sash door price x 2

**NOTE:** the third Estetic 80 hinge for non-rebated doors (the surcharge is added to the price of the door frame)

The sashes, depending on the selected variant, have a height of 1983 mm, 2110 mm or 2240 mm - they are dedicated to rebated door frames with three hinges, in appropriate height variants.

## DECOR DRE-CELL

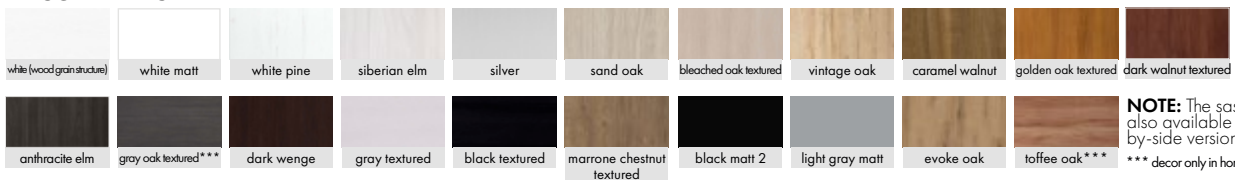

## LAMINATE CPL



\* Door sash width: single sash "60"÷"100", double sash rebated "120" ÷ "200", double sash non-rebated "120" ÷ "180".



# PLUS

DOORS WITH VARIABLE HEIGHTS



**NOTE:** the third Estetic 80 hinge for non-rebated doors (the surcharge is added to the price of the door frame)

The sashes, depending on the selected variant, have a height of 1983 mm, 2110 mm or 2240 mm - they are dedicated to rebated door frames with three hinges, in appropriate height variants.

## IN STANDARD

- Softwood frame.
- Honeycomb filling.
- Glass MAT DRE.

## REBATED DOOR SASH

- Straight edge, flat glazing bar (in CPL laminate - rounded) in the sash decor, flat HDF panels, th. 4mm.
- 3 silver screw-in hinges.
- Lever tumbler lock with a regular key, bathroom lock, cylinder lock or economy lock.

## NON-REBATED HINGED DOOR SASH

- Edge without rebate, flat glazing bar (in CPL laminate - rounded) in the sash decor, flat HDF boards th. 4mm.
- Sockets for 2 recessed Estetic 80 hinges (hinges are part of the door frame equipment).
- Magnetic lock for a regular key, bathroom lock, cylinder lock or economy lockme equipment).

## WITHOUT EXTRA CHARGE

Ventilation sleeves.

DECORMAT BROWN, DECORMAT GRAPHITE, chinchila, blinds, white bark

## WITH EXTRA CHARGE

Frosted glass VSG 22.1 safety composite:

PLUS 20, 30, 40, 50, 60, 70, 80.

Filling perforated chipboard.

Non-rebated casement sashes.

Filling:

- perforated chipboard (1983)

- perforated chipboard (2110 i 2240)

Sashes „90“-„100“ (1983)

Sashes „90“-„100“ (2110 i 2240)

Ventilation undercut.

Plastic ventilation grille.

Aluminium ventilation grille.

Cover strip for non-rebated double-sash doors.

Double-sash door price x2.



## DECOR DRE-CELL

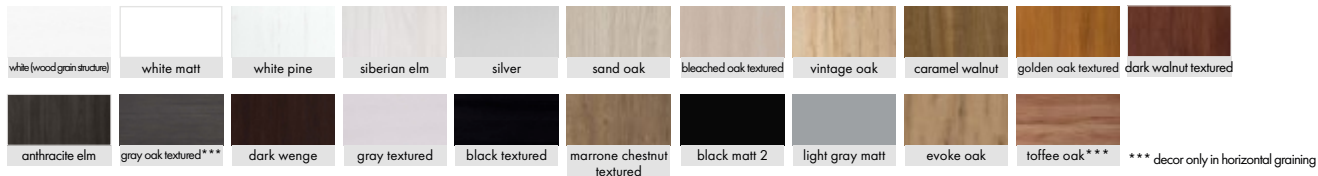

## LAMINATE CPL

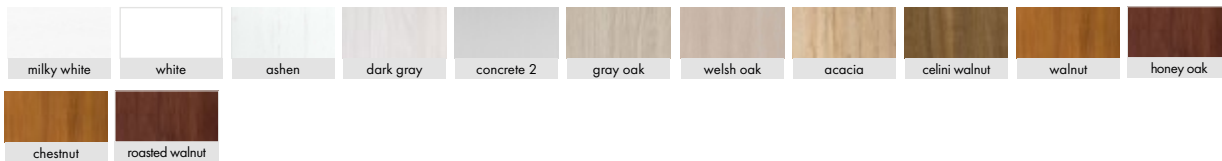

\*Door sash width: single sash "60"÷"100", double sash rebated "120" ÷ "200", double sash non-rebated "120" ÷ "180".

# MODERN

DOORS WITH VARIABLE HEIGHTS



**NOTE:** the third Estetic 80 hinge for non-rebated doors (the surcharge is added to the price of the door frame)

The sashes, depending on the selected variant, have a height of 1983 mm, 2110 mm or 2240 mm - they are dedicated to rebated door frames with three hinges, in appropriate height variants.

## IN STANDARD

- Softwood frame.
- Honeycomb filling.
- Glass MAT DRE.

## REBATED DOOR SASH

- Straight edge, flat glazing bar (in CPL laminate - rounded) in the sash decor, flat HDF panels, th. 4mm.
- 3 silver screw-in hinges.
- Lever tumbler lock with a regular key, bathroom lock, cylinder lock or economy lock.

## NON-REBATED HINGED DOOR SASH

- Edge without rebate, glazing flat frame (in CPL laminate - rounded) in sashes decor, HDF flat panels 4 mm.
- Sockets for 2 recessed Estetic 80 hinges (hinges are part of the door frame equipment).
- Magnetic lock for a regular key, bathroom lock, cylinder lock or economy lockme equipment).

## WITHOUT EXTRA CHARGE

Ventilation sleeves.

DECORMAT BROWN, DECORMAT GRAPHITE, chinchilla, blinds, white bark.

## WITH EXTRA CHARGE

Frosted glass VSG 22.1 safety composite:

MODERN 20, 30, 40, 50.

Filling perforated chipboard.

Non-rebated casement sashes.

Filling:

- perforated chipboard (1983)

- perforated chipboard (2110 i 2240)

Sashes „90“-„100“ (1983)

Sashes „90“-„100“ (2110 i 2240)

Ventilation undercut.

Plastic ventilation grille.

Aluminium ventilation grille.

Cover strip for non-rebated double-sash doors.

Double-sash door price x2.

\*Door sash width: single sash "60"÷"100", double sash rebated "120" ÷ "200", double sash non-rebated "120" ÷ "180".



**DECOR DRE-CELL**

white (wood grain structure)	white matt	white pine	siberian elm	silver	sand oak
bleached oak textured	vintage oak	caramel walnut	golden oak textured	dark walnut textured	anthracite elm
gray oak textured***	dark wenge	gray textured	black textured	marrone chestnut textured	black matt 2
light gray matt	evoke oak	toffe oak***	<b>NOTE:</b> The sashes in white matt are also available in a non-rebated side-by-side version. *** decor only in horizontal graining		

**LAMINATE CPL**

milky white	white	ashen	dark gray	concrete 2	gray oak
welsh oak	acacia	celini walnut	walnut	honey oak	chestnut
roasted walnut					



# SLIDING SYSTEM

## WALL

The DRE wall-mounted sliding system is designed for single or double-sash interior doors in a sliding variant.

It can be used for doors in our offer, in the following finishes: DRE-Cell, 3D foil, CPL laminates, as well as painted doors except for the collection: Enter Akustik, doors with variable heights.

We offer two types of sliding systems:

NS - system mounted directly on the wall

NT - system installed using an adjustable tunnel

There are two variants of System NT:

– for a tunnel with a 63 mm angle bar

– for a tunnel with an 80 mm angle bar

The NS sliding system includes: a guide (LEON SN 150, 180, 200) with HARDWARE, a spacer strip, a cover plate and a fender beam (the beam is only for single-sash doors, for doors with a lock there is a milling for the catch in the beam).

The NT system is additionally supplied with two 16 mm thick spacer strips with cross-sections adapted to the width of the angle bars 63 mm or 80 mm. The NS and NT systems also differ in the cross-section of the grille.

To complete the set of sliding doors, you need to buy a SLIDING DOOR Sash in the following dimensions:

– Single door: "60", "70", "80", "90", "100"

– Double doors: "2x60", "2x70", "2x80", "2x90", "2x100"

The sashes can be equipped with sockets for a lock and/or handles - these accessories must be purchased separately.

In the case of the NT system, an adjustable tunnel must also be purchased.

## ACCESSORIES

Round handle 1 pc.

Oval handle 1 pc.

Bolt keeper lock with a key, with two round or oval handles.

Toilet bolt keeper lock with two round or oval handles.

Bolt keeper lock with patent insert, with two round handles.

A set of handles for one sash consists of 2 pcs.

**PL**

PL Standard

**SK**

SK Standard



Single sliding system

Door dimension [mm]	Mask		Guiding rail
	Mz	Mw	Pa
644, 744	1620	1588	1500
844	1920	1888	1800
944	2120	2088	2000
1044	2160	2128	2000

Grille with a guiding rail

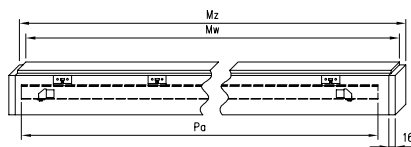

The cover plate and the guide for double systems are obtained by combining two elements from a single system.

NS - vertical section

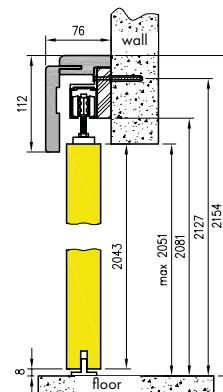

Double sliding system

Door dimension [mm]	Mask		Guiding rail
	Mz	Mw	Pa
2x 644	2x 1519	2x 1503	2x 1500
2x 744	2x 1519	2x 1503	2x 1500
2x 844	2x 1819	2x 1803	2x 1800
2x 944	2x 2019	2x 2003	2x 2000
2x1044	2x 2063	2x 2047	2x 2000

NT - vertical section on the tunnel with an angle. 63mm

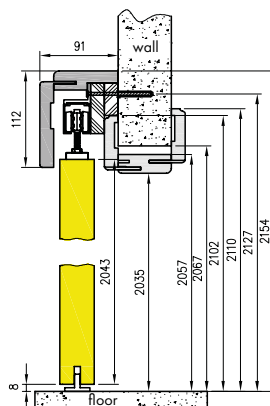

NT - vertical section on the tunnel with an angle. 80mm

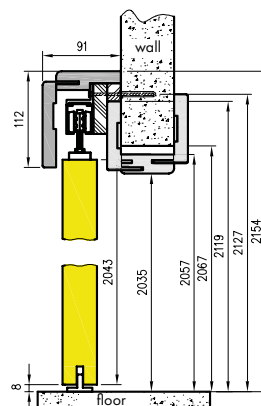

Single sliding system

Symbol	"60"	"70"	"80"	"90"	"100"
A	602	702	802	902	1002
C	646	746	846	946	1046
D	664	764	864	964	1064
E	752	852	952	1052	1152
E*	786	886	986	1086	1186
S	644	744	844	944	1044

Double sliding system

Symbol	"120"	"140"	"160"	"180"	"200"
A	1200	1400	1600	1800	2000
C	1244	1444	1644	1844	2044
D	1264	1464	1664	1864	2064
E	1350	1550	1750	1950	2150
E*	1384	1584	1784	1984	2184
S	644	744	844	944	1044

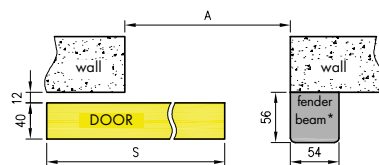
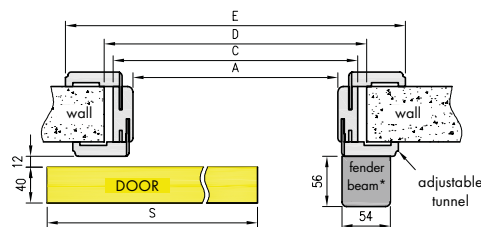

E\* – applies to the tunnel angle. T80  
S\*\* – width of one sash

**NOTE:** In double sliding systems, the masking panel is joined along its length from two elements.

# SPAZIO CD WALL SLIDING SYSTEM

SLIDING DOOR SASHES - INTERNAL INTERIOR



golden golden satin chrome chrome satin black



bolt keeper lock with key and round handle



bolt keeper lock with key and oval handle

**PL**

PL Standard

**SK**

SK Standard

## DECOR DRE-CELL

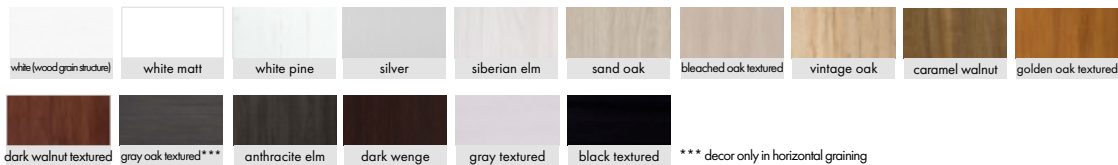

## DECOR 3D

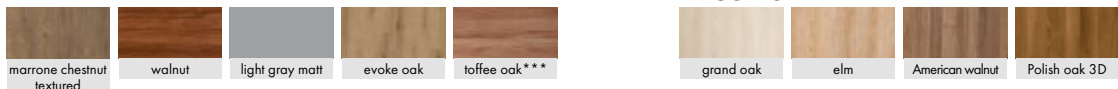

## LAMINATE CPL\*

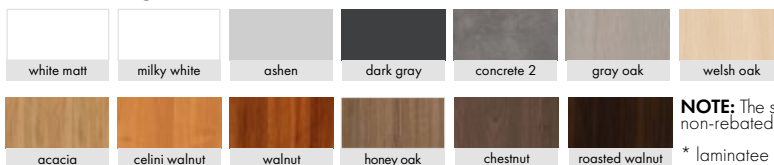

**NOTE:** The sashes in white matt are also available in a non-rebated side-by-side version.

\* laminate available in models 10, 20, 30, 50, 60

## CONSTRUCTION

Wall-mounted sliding system with anodized guide and rectangular cover. Intended for plate and frame door sashes. This is a solution for the finished reveal. No adjustable tunnel.

It can be used for doors in our offer, in the following finishes: DRE-Cell, 3D foil, CPL laminates, as well as painted doors, except for the collection: Enter Akustik, doors with variable heights.

- Guide with side caps.
- System carriages.
- Door sash mounting brackets.
- Bottom guide.
- Mounting kit (bolts, screws).

## ACCESSORIES

- Round handle 1 pc.
- Oval handle 1 pc.
- A set of handles for one sash consists of 2 pcs.

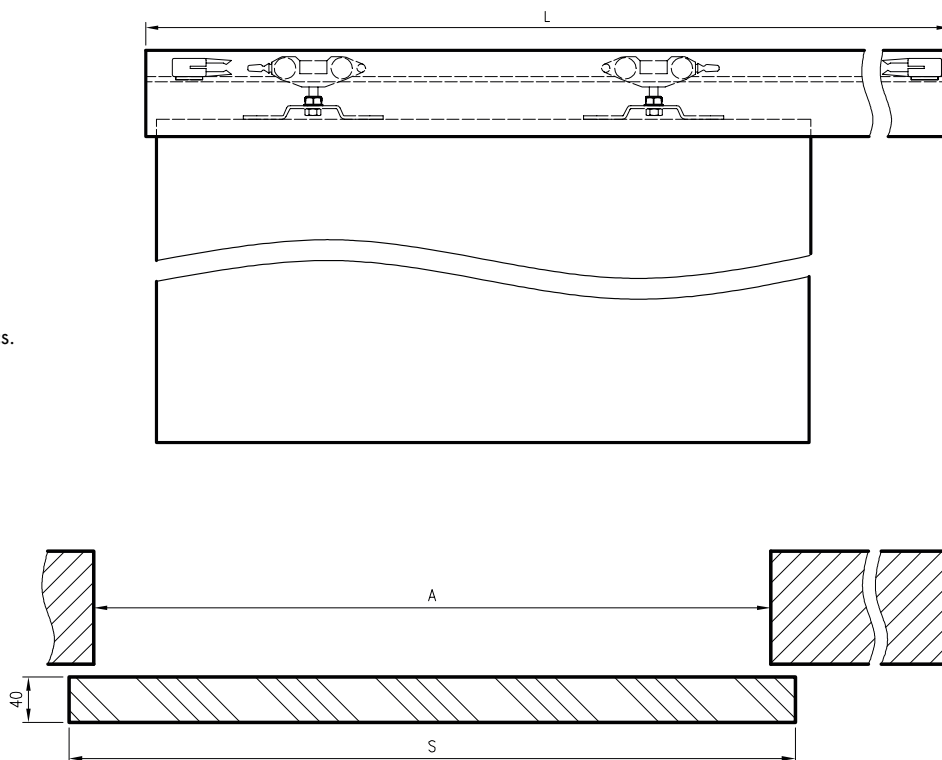
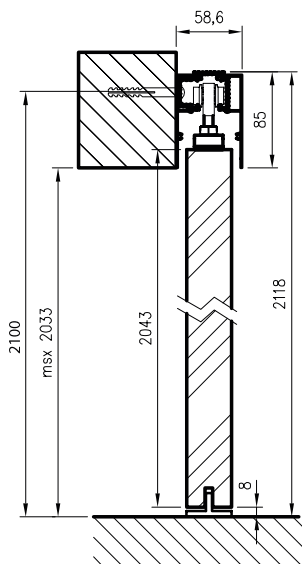

	A	S	L
"60"	600	644	1370
"70"	700	744	1570
"80"	800	844	1770
"90"	900	944	1970
"100"	1000	1044	2170

A – The width of the opening in the wall

S – Sash width

L – Guiding rail length

## ACCESSORIES

Round handle 1 pc.

Oval handle 1 pc.

Bolt keeper lock with a key, with two round or oval handles.

Toilet bolt keeper lock with two round or oval handles.

Bolt keeper lock with patent insert, with two round handles.

A set of handles for one sash consists of 2 pcs.

Door sash width: single sash "60"÷"100".

# FRAME CASSETTE PA

SLIDING DOOR SASHES - INTERNAL INTERIOR

## FRAME CASSETTE PA

Installation of the system assumes embedding the cassette in the structure of profiles used to build a plasterboard wall (or other structure) with a thickness of:

- 100mm for the PA 100mm door frame cassette
- 125mm for the PA 125mm door frame cassette

Then, covering wide surfaces with plasterboards 12.5 mm thick (plasterboards must be purchased separately) and finishing these surfaces and installing the Cassette Tunnel Housing.

**NOTE:** The VETRO A, VETRO D and VETRO B doors with a width of 70, Enter Akustik, doors with variable heights are not suitable for the 100 mm and 125 mm PA cassettes. In addition, the 100 mm PA cassettes cannot be fitted with door sashes with locks and board doors with glazing or panels.

## THE SET INCLUDES

- Cassette elements made of aluminium elements and accessories allowing for its assembly
- Elements that allow for decorative development of the resulting reveal, the so-called Tunnel Housing Cassettes with 80 mm wide angle bars

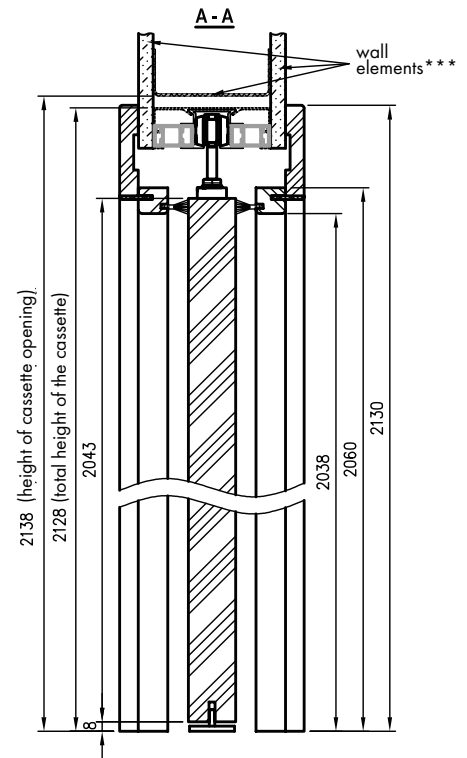

**PL**

PL Standard

**SK**

SK Standard



golden golden satin chrome chrome satin black



bolt keeper lock with key and round handle

bolt keeper lock with key and oval handle

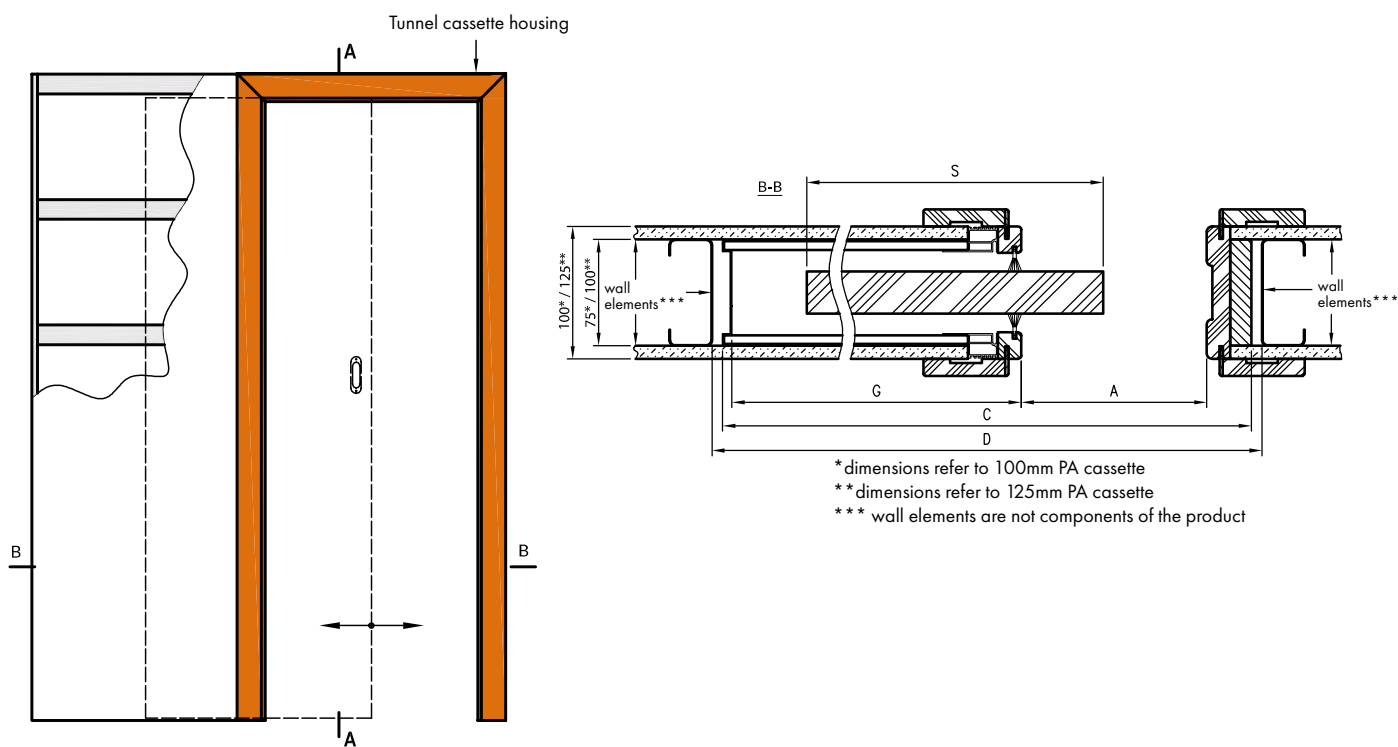

## ACCESSORIES

Round handle 1 pc. Oval handle 1 pc.

Bolt keeper lock with a key, with two round or oval handles.

Toilet bolt keeper lock with two round or oval handles.

Bolt keeper lock with patent insert, with two round handles.

A set of handles for one sash consists of 2 pcs.

In addition, the 100 mm PA cassettes cannot be fitted with door sashes with locks and board doors with glazing or panels.

	A	S	C	D	G
"60"	600	644	1310	1330	656
"70"	700	744	1510	153	756
"80"	800	844	1710	1730	856
"90"	900	944	1910	1930	956
"100"	1000	1044	2110	2130	1056

A - The width of the opening in the wall

S - sash width

C - total cassette width

D - width of the opening for the cassette

G - depth of the finished cassette

Door sash width: single sash "60"÷"100".

# TECHNICAL INFORMATIONS

## DOOR DRE

### MASKING BANDS

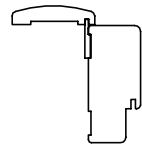
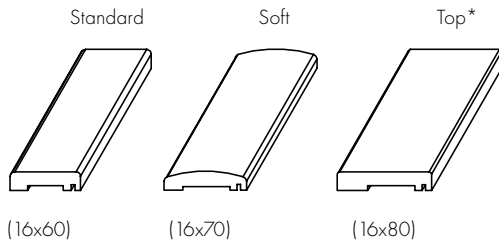

Connection of the band with the frame

**Contents of the set** (for one side of the door): horizontal and two vertical bands, plastic bolt keepers, pins and clamping clips.

Masking bands are packed in a cardboard box.

### A QUARTER

The quarter round is used to mask the angular connection of the wall and the frame.



16x16x2200 mm



SOFT  
11x18x2200 mm

### VENTILATION GRILLES

The door can be fitted with a plastic bathroom ventilation grille, available in white, beige, calvados, brown, silver, cream, gray, black and gray colours (except frame, sliding doors, ENTER) or aluminium.



Plastic ventilation grille



Aluminium ventilation grille

### VENTILATION UNDERCUT

In all collections (except ENTER, sliding), ventilation undercut can be made on request.



### HINGE CAPS

Plastic caps adapted to hinges with a diameter of 13.5.



(set of 2 pieces for 1 hinge)

# SASH DIMENSIONS AND HINGE LOCATION

Rebated sashes

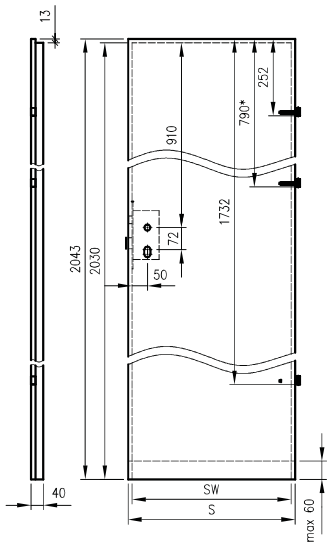

Rebated sashes:  
Standard 10, Modern, Plus

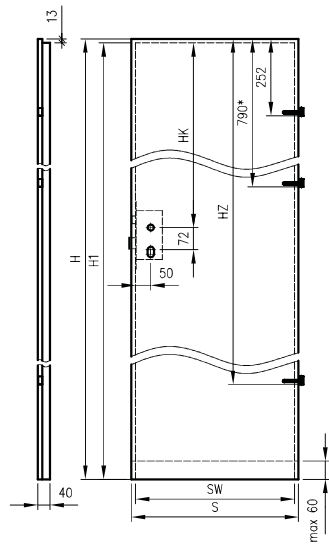

Sara Eco 2 Rebated sashes  
202X Standard

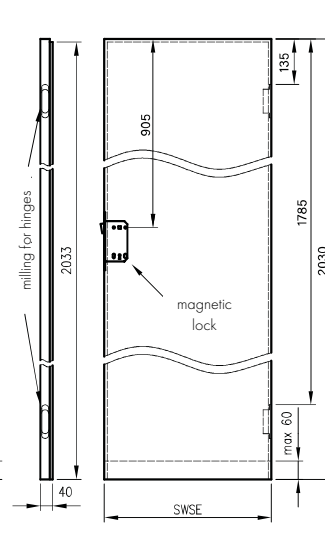

Non-rebated turn sashes

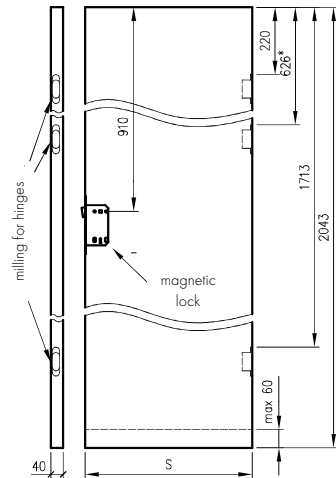

Non-rebated door sashes:  
Standard 10, Modern, Plus

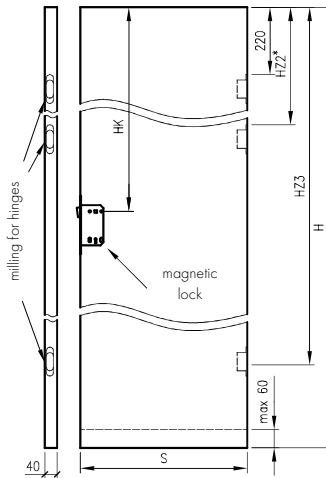

Sara Eco 2 non-rebated  
door sashes in the 202X standard

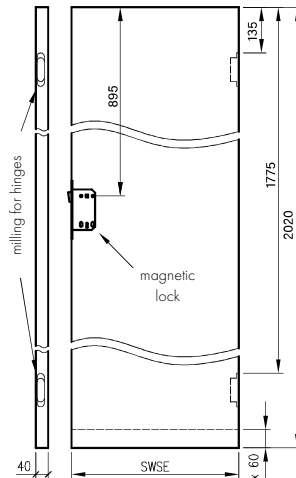

Sliding sashes for:  
- PA door frame cassettes  
- SPAZIO CD systems  
- wall systems

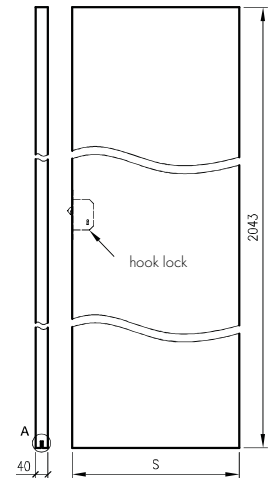

\*if present

NOTE: magnetic locks in two variants of spacing:  
85mm for profile cylinder or 90mm for regular key and toilet.

A - guiding  
milling

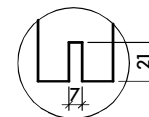

A - guide profile  
in VETRO A, B, D

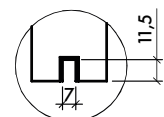

# SASH DIMENSIONS

IN 4 HEIGHT VARIANTS

DOOR WIDTH	S	SW	SWSE
"60"	644	618	620
"70"	744	718	720
"80"	844	818	820
"90"	944	918	920
"90E" ENTER/AKUSTIK	948	922	-
"100"	1044	1018	1020
"110"*	1144	1118	-

S - total sash width

SW – width in the rebate (concerns rebated door sashes)

SWSE - Sara Eco sash width 2

H	H1	HK	HZ	HZ2	HZ3
1983	1970	850	1672	606	1653
2043	2030	910	1732	626	1713
2110	2097	977	1799	647	1780
2240	2227	1107	1929	691	1910

(applies to STANDARD 10 door sashes and the MODERN and PLUS collections)

H - total height of the sash

H1 - Sash height in the notch

HK - distance from the upper notch of the sash to the axis of the handle

HZ - distance from the upper edge of the sash to the point of embedding third hinge

## WEIGHT OF THE SASHES

2043 mm – total height of rebated and non-rebated door sashes

2030 mm – height of rebated door sashes in the rebate (2020 for Sara Eco 2 rebated door sashes,

2055 mm – total height of door sashes with inverted rebate

1983, 2043, 2110, 2240 mm – total possible heights of STANDARD 10 door sashes and MODERN and PLUS collections (1970, 2030, 2097, 2227 mm - measured in the rebate)

### SHORTENING THE SASHES

It is possible to shorten the door sashes on your own, up to 60 mm (the VETRO door sashes, all collections in the sliding version, passive doors and doors with a drop down gasket cannot be shortened).

### THRESHOLD SLOTS

The standard height of the gap between the door sash and the finished floor is 8 mm.

### HINGE NOTES

Rebated door sashes: frame, entrance (Enter Akustik) and other collections with a width of not less than "90" are fitted with 3 screw-in hinges ø 13.5 mm. In other interior rebated door sashes, it is possible to choose 2 or 3 hinges.

Non-rebated turn sashes have milled slots for 2 or 3 recessed hinges, which are packed with the door frame.

Rebated and non-rebated Sara Eco 2 door sashes have milled sockets for recessed hinges, which are packed together with the door frame.

Door sashes with inverted rebate have milled slots for 2 recessed hinges, which are packed together with the door frame.

Door sash type	The thickness of the sashes	Sash proportion (w0/z0)	Recommended**	Applies to the knob insert	
				Cylinder with a knob on the inside (W/Z)	Cylinder with a knob on the inside (W/Z)
Rebated sashes	40	14/26	25/40 26/36 26/41 30/40	25G/40 26G/36 26G/41 30G/40	25/40G 26/36G 26/41G 30/40G
Rebated sashes Sara Eco 2	40	24/16	35/30 36/26 36/31 40/30	35G/30 36G/26 36G/31 40G/30	35/30G 36/26G 36/31G 40/30G
Non-rebated door sashes	40	20/20	31/31 30/30 35/35	31G/31 30G/30 35G/35	
Non-rebated door sashes Sara Eco 2	40	16/24	30/35 26/36 31/36 30/40	30G/35 26G/36 31G/36 30G/40	30/35G 26/36G 31/36G 30/40G
A sash with an inverted rebate	40	27/13	40/25 41/26	40G/25 41G/26	40/25G 41/26G

\* The inserts are reversible - i.e. 25/40 = 40/25, 26G/36 = 36/26G

\*\* Dimension recommended assuming that the backplate is 10 mm thick and the insert protrudes above the backplate no more than 5 mm.

Fig. Selection of cylinder insert dimensions

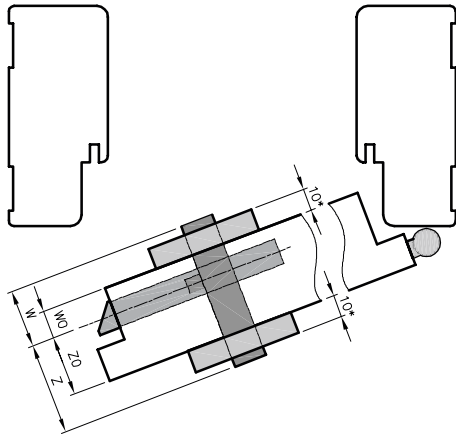
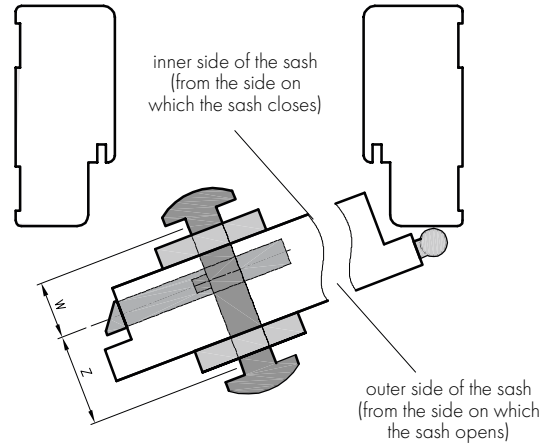

Fig. Selection of cylinder dimensions with a knob



**The dimension of the insert is calculated from the formula:**

$W0 + \text{backplate thickness} + 2 \div 3\text{mm} / Z0 + \text{backplate thickness} + 2 \div 3\text{mm}$  where:  
W0 and Z0 - values are given in the table above the thickness of the signboard - we measure it (the table assumes that the signboard is 10 mm thick)

- Selection of the insert with the knob - if we want to mount the knob after:
- the inside of the door sash - the symbol of the knob must be next to the dimension "W" (see 5th column in the table)
  - external side of the sash - the symbol of the knob must be next to the dimension "Z" (see 6th column in the table)

# SINGLE REBATED DOOR SASHES

WE OFFER SASHES: RIGHT, LEFT

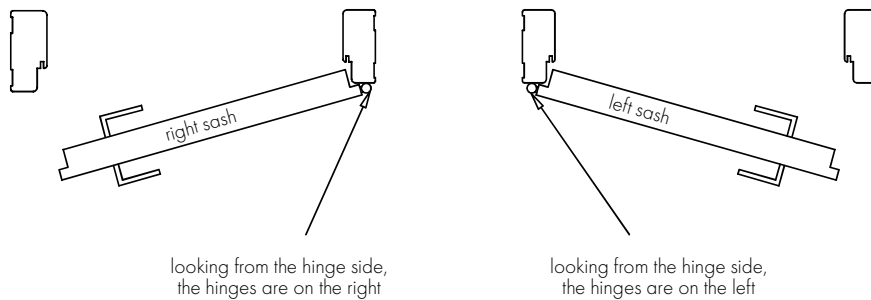

# DOUBLE REBATED DOOR SASHES

We offer double sashes: right - then the right sash is active and the left one is passive, and double left sashes - then the left sash is active and the right one is passive.

The active sash has a rebate and an in standard lock. For double-sash doors, the edge on the side where the lock of the active and passive sash is placed, on the side where the catch is placed, is always a straight edge. The passive sash has a "counter-rebate" and in standard catch plate and "cantilever"

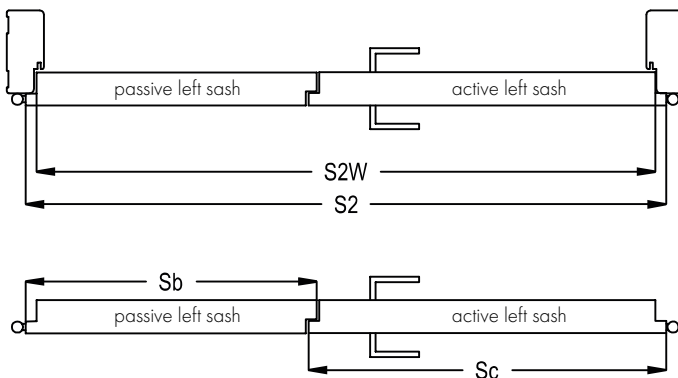

Only our door frames are suitable for double-sash doors, so we recommend buying the doors in sets. The DRE set includes 2 door sashes and a door frame.

Dimension symbol	dimensions in [mm]		
	S2	S2W	combination * Sc+Sb
"120"	1278	1252	644+644
"130"	1378	1352	744+644; 644+744
"140"	1478	1452	844+644; 744+744; 644+844
"150"	1578	1552	944+644; 844+744; 744+844; 644+944
"160"	1678	1652	944+644; 844+744; 844+844; 744+944; 644+1044
"170"	1778	1752	1044+744; 944+844; 844+944; 744+1044
"180"	1878	1852	1044+844; 944+944; 844+1044
"190"	1978	1952	1044+944; 944+1044
"200"	2078	2052	1044+1044

\*combination - possible combinations of sash width

$$\boxed{\text{double-sash door price}} = \boxed{\text{sash price x2}} + \boxed{\text{frame price}}$$

# NON-REBATED-SLIDING SASHES

WE OFFER SASHES: RIGHT, LEFT AND CENTRE (DOOR WITHOUT LOCK AND HANDLE)

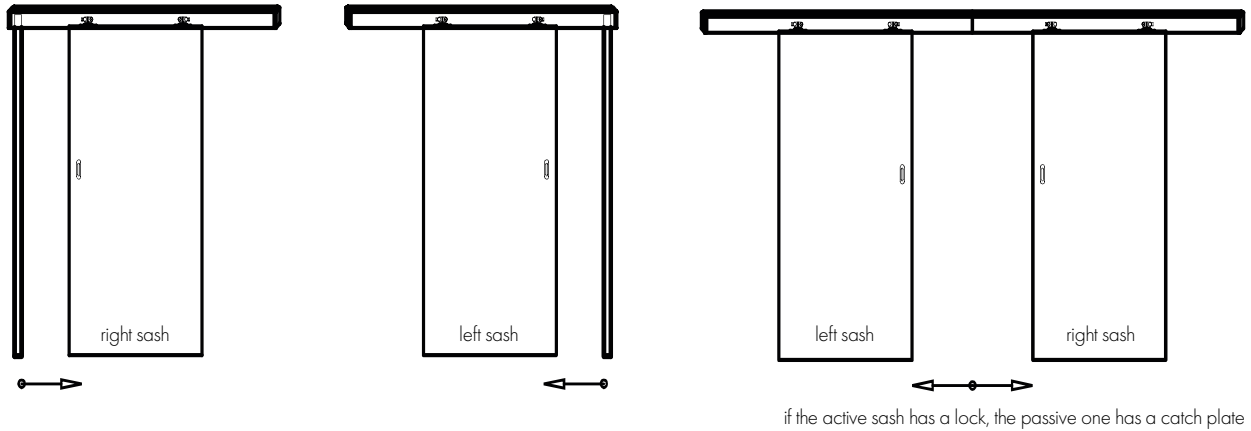

# NON-REBATED SINGLE DOOR SASHES

WE OFFER SASHES: RIGHT, LEFT

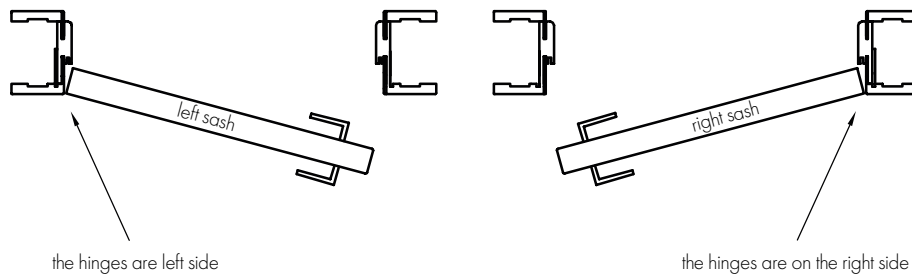

Looking from the side of the room into which the door opens

# NON-REBATED DOUBLE SASHES

WE OFFER SASHES: RIGHT, LEFT AND CENTRE (DOOR WITHOUT LOCK AND HANDLE)

We offer double sashes: right - then the right sash is active and the left one is passive, and double left sashes - then the left sash is active and the right one is passive.

The active sash has an IN STANDARD lock, while the passive sash has a catch plate and a "cantilever".

\* for non-rebated double-sash doors, it is possible to buy them separately cover strip width 30 mm

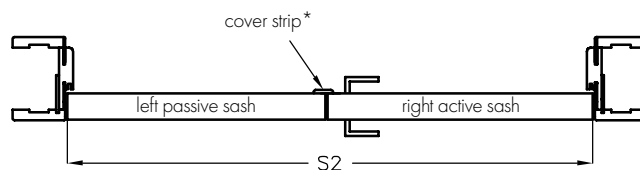

double-sash door price	=	sash price x2	+	frame price
------------------------	---	---------------	---	-------------

Dimension symbol	dimensions in [mm]	
	S2	combination* Sc+Sb
"120"	1291	644+644
"130"	1391	744+644; 644+744
"140"	1491	844+644; 744+744; 644+844
"150"	1591	944+644; 844+744; 744+844; 644+944
"160"	1691	944+644; 844+744; 844+844; 744+944; 644+1044
"170"	1791	1044+744; 944+844; 844+944; 744+1044
"180"	1891	1044+844; 944+944; 844+1044

\*combination - possible combinations of active (Sc) and passive (Sb) sash widths

# CONSTRUCTION OF PLATE WINGS

---

The sash frame is made of softwood or MDF board

Filling: honeycomb stabilizing insert (A), perforated chipboard (B) and in the fire door:

Chipboard

HDF 3 mm outer panel or HDF 4 mm outer panel (EnterAkustik)

Straight edge or no rebate

Outer panels of the sashes are refined with:

a) decor in the DRE-Cell collection - decorative foil based on polypropylene

b) in 3D foil - 3D foil based on decorative paper

c) in CPL laminate - CPL laminate gr. 0.15 - 0.2mm or 0.7mm

## FRAME WINGS CONSTRUCTION

(EXCLUDES VETRO COLLECTION A, B, C, D)

---

The structure of the frame sashes is made entirely of wood-based panels:

vertical stiles made of wood-based panels - 40 mm

external horizontal stiles made of wood-based boards - 35 mm internal horizontal stiles:

- wood-based panels - 22 mm in Auri door sashes,

- wood-based panels - 35 mm in Estra door sashes.

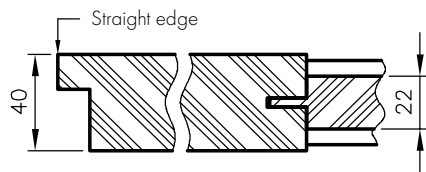

# OTHER TECHNICAL INFORMATION

1. While maintaining the standard dimensions of door sashes and frames, the gap between the "ready" floor and the lower edge of the door sash is 8 mm.

2. Attention! Before buying and installing woodwork, check whether the selected type of joinery complies with the requirements of the technical design developed for a given project, in particular, make sure that the structure of the walls and ceilings enables the installation of joinery with the weight specified in the table below:

	Door sashes		Door frames		Other products	
	intra-cage	input	regular	easy	adjustable tunnel	sliding system
<b>Weight max</b>	50 kg*	50 kg*	40 kg	20 kg	40 kg	20 kg

\* maximum weight of 1 sash

3. The sash is packed in heat-shrinkable foil, and the edges are additionally secured with polystyrene or cardboard inserts.

## VENTILATION UNDERCUTS

standard undercut in the door

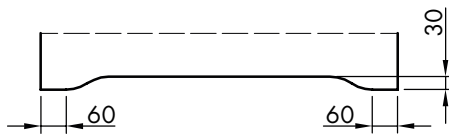

undercut in the Vetro A door

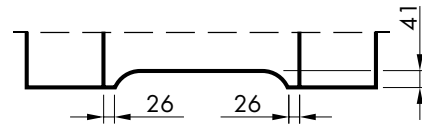

undercut in the Vetro D door

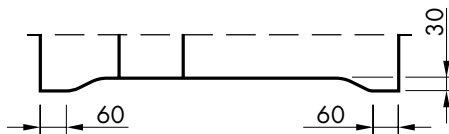

undercut in the Vetro B door

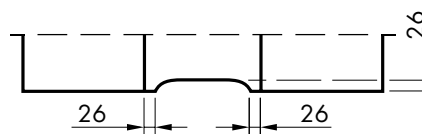

# STRAIGHT DOOR FRAMES

REBATED

## CONSTRUCTION

The straight door frame is made of high-quality wood-based panels and covered with ecological, wood-like DRE-Cell decorative foil, 3D foil, CPL laminate 0.15 - 0.2 mm, Finish foil or painted.

The door frame has a fixed width of 100 mm.

## APPLICATION

The straight door frame is applicable to the following doors:

- ENTER entrance doors (equipped with 3 hinges  $\varnothing$  13.5 mm and an additional upper catch)
- other rebated doors (using 2 or 3 hinges  $\varnothing$  13.5 mm, 3 hinges for frame and slab doors with a width of "90" and wider)

We use masking bands for the straight and straight SOFT door frames.

## CONTENT OF THE SET

Main beam (horizontal element and two vertical elements), door gasket, set of hinges, a set of elements for assembling the door frame according to the enclosed instructions. Door frames are packed in cardboard packaging.

PROFILE OP

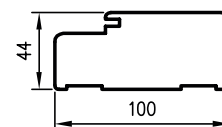

OP SOFT PROFILE

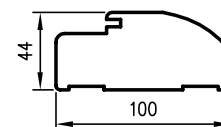

OP VERTICAL SECTION FOR REBATED DOORS

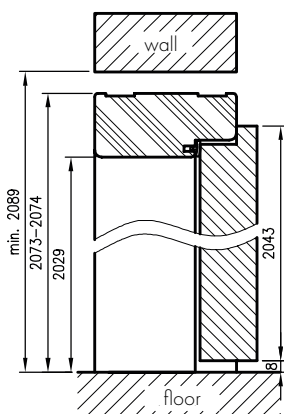

OP VERTICAL SECTION FOR GLASS DOORS

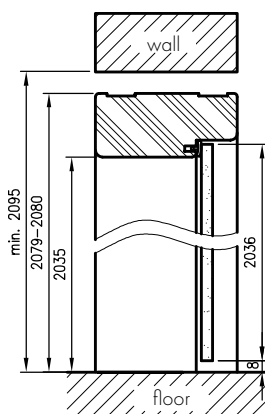

HORIZONTAL SECTION OP

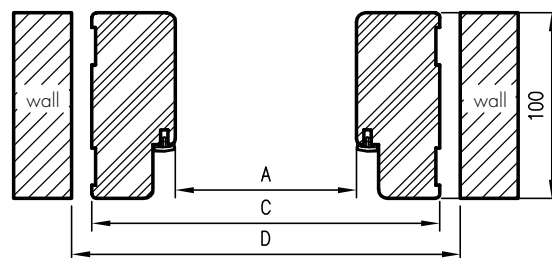

## WITH EXTRA CHARGE

- ENTER door frame (with lever tumbler catch)
- Door frame for double-sash doors

For single-sash doors\*

	A	C	D
"60"	600	688	712
"70"	700	788	812
"80"	800	888	912
"90"	900	988	1012
"90E"	904	992	1016
"100"	1000	1000	1112

For double-sash doors

	A	C	D
"120"	1235	1323	1347
"130"	1335	1423	1447
"140"	1435	1523	1547
"150"	1535	1623	1647
"160"	1635	1723	1747
"170"	1735	1823	1847
"180"	1835	1923	1947
"190"	1935	2023	2047
"200"	2035	2123	2147

# STRAIGHT DOOR FRAMES

NON-REBATED

## CONSTRUCTION

The straight non-rebated door frame is made of high-quality wood-based panels and covered with ecological, wood-like DRE-Cell decorative foil, 3D foil, CPL laminate 0.15 - 0.2 mm or painted.

The door frame has a fixed width of 100 mm.

## APPLICATION

The straight non-rebated door frame applies to all DRE collections in the non-rebated side-by-side version.

## CONTENT OF THE SET

Main beam (horizontal element and two vertical elements), door gasket, set of hinges, a set of elements for assembling the door frame according to the enclosed instructions. Door frames are packed in cardboard packaging.

Profil OPB

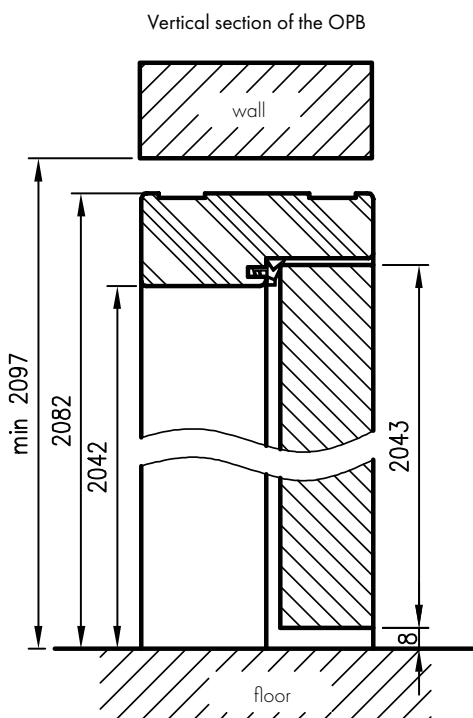
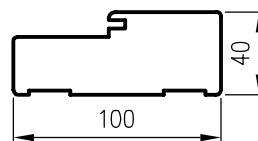

Horizontal section of the OPB

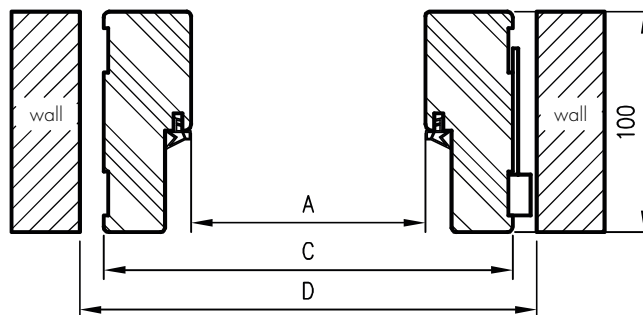

For single-sash doors

	A	C	D
"60"	627	707	730
"70"	727	807	830
"80"	827	907	930
"90"	927	1007	1030
"100"	1027	1107	1130

For double-sash doors

	A	C	D
"120"	1274	1354	1380
"130"	1374	1454	1480
"140"	1474	1554	1580
"150"	1574	1654	1680
"160"	1674	1754	1780
"170"	1774	1854	1880
"180"	1874	1954	1980

Prices include 2 hinges with fixing plates.

- Price of the door frame for double-sash doors (additional charge if 3 hinges are used)

- Surcharge for the third Estetic 80 hinge

# ADJUSTABLE FRAMES

WITH ANGLE T80 OR T63

## CONSTRUCTION

The adjustable door frame with the T80 or T63 angle bar is equipped with angle bars with small rounding radii of the transverse profile. It is made of high-quality wood-based board. From the display side, it is covered entirely with a wood-like decorative DRE-Cell Decor foil, 3D foil, CPL laminate, thickness. 0.15 - 0.2 mm or painted\*\*.

Its design allows it to be used for walls with a thickness of 60 - 320 mm.

\*\* In order to ensure high quality of painted door frames, they are covered with a special material constituting a uniform base before varnishing.

## APPLICATION

The adjustable door frame applies to:

- Interior doors - rebated and for glass doors (ORC)
- ENTER entrance door (includes 3 hinges ø 13.5 mm, additional catch)

## CONTENT OF THE SET

Main beam (horizontal and two vertical elements together with masking elements), door gasket, set of hinges, set of elements for assembling the door frame according to the enclosed instructions.

Door frames are packed in cardboard packaging.

All door frames for the frame door collection and door frames 90 and wider should be equipped with 3 hinges.

OR/ORC section with angle.T63

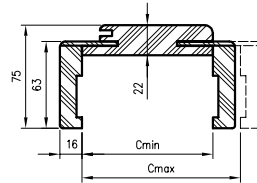

OR/ORC section with angle.T80

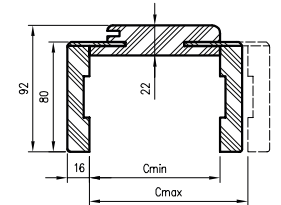

OR/ORC horizontal section

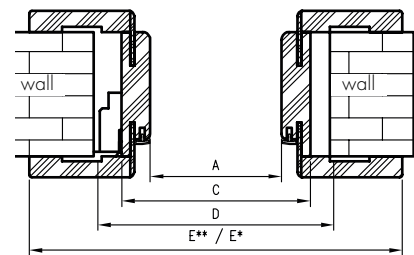

D - required width of the opening in the wall

Vertical section of the rebated door with OR

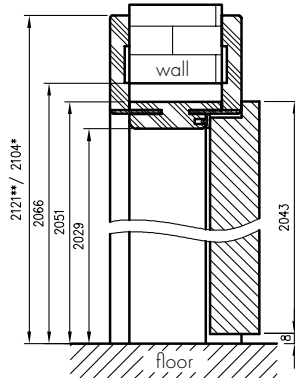

Double door frame price: +30%

\*\*\* The door frame for the wall 060-075 has a shallower groove on the side of the movable angle bar, it will be necessary to shorten the tongues of these angle bars during assembly.

### Wall thickness

Cmin	Cmax
65***	75
75	95
95	115
120	140
140	160
160	180
180	200
200	220
220	240
240	260
260	280
280	300
300	320

For single-sash doors

	A	C	D	E**	E*
"60"	602	646	680	786	752
"70"	702	746	780	886	852
"80"	802	846	880	986	952
"90"	902	946	980	1086	1052
"100"	1002	1046	1080	1086	1152

For double-sash doors

	A	C	D	E**	E*
100d	1035	1079	1115	1219	1185
110d	1135	1179	1215	1319	1285
120	1235	1279	1315	1419	1385
130	1335	1379	1415	1519	1485
140	1435	1479	1515	1619	1585
150	1535	1579	1615	1719	1685
160	1635	1679	1715	1819	1785
170	1735	1779	1815	1919	1885
180	1835	1879	1915	2019	1985
190	1935	1979	2015	2119	2085
200	2035	2079	2115	2219	2185

# ADJUSTABLE FRAMES

VARIABLE HEIGHTS WITH T80 ANGLE

## APPLICATION

The height-adjustable door frame with the T80 angle bar can be used with the Standard 10, Modern and Plus rebated door sashes in three additional door sash height options: 1983 mm, 2110 mm and 2240 mm.

## CONTENT OF THE SET

Main beam (horizontal and two vertical elements together with masking elements), door gasket, set of elements for assembling the door frame according to the enclosed instructions.

Door frames are packed in cardboard packaging.

OR section with angle.T80

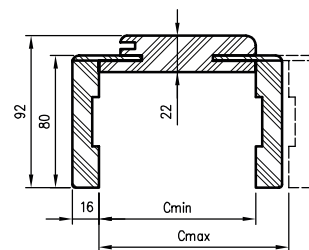

Vertical section OR

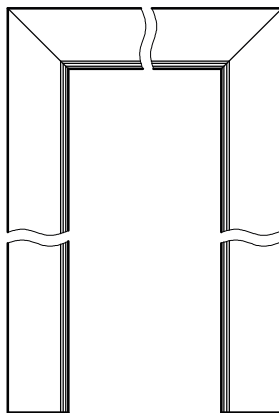
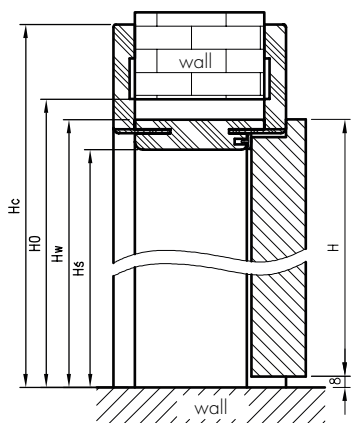

OR horizontal section

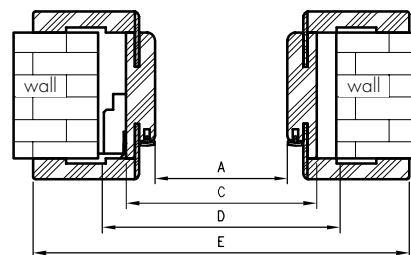

D - required width of the opening in the wall  
H - Sash height  
H0 - required height of the opening in the wall

H	H <sub>s</sub>	H <sub>w</sub>	H <sub>0</sub>	H <sub>c</sub>
1983	1969	1991	2006	2061
2110	2096	2118	2133	2188
2240	2226	2248	2263	2318

For single-sash doors

	A	C	D	E
"60"	602	646	680	786
"70"	702	746	780	886
"80"	802	846	880	986
"90"	902	946	980	1086
"100"	1002	1046	1080	1186

For double-sash doors

	A	C	D	E
"120"	1235	1279	1315	1419
"130"	1335	1379	1415	1519
"140"	1435	1479	1515	1619
"150"	1535	1579	1615	1719
"160"	1635	1679	1715	1819
"170"	1735	1779	1815	1919
"180"	1835	1879	1915	2019
"190"	1935	1979	2015	2119
"200"	2035	2079	2115	2219

# ADJUSTABLE FRAMES

NON-REBATED

## CONSTRUCTION

Non-rebated adjustable door frame is made of high-quality wood-based board. From the display side, it is entirely covered with a wood-like decorative DRE-Cell Decor foil, 3D foil, CPL laminate or painted\*\*.

Its structure is adapted to the sash thickness of 40 mm and allows it to be used for walls with a thickness of 75 - 320 mm. In white matt, black matt 2, white painted acrylic UV, white pine, sand oak, Polish 3D oak, possible choice of beam connection angle 90°.

\*\* To ensure high quality of painted and varnished door frames, they are covered with a special material constituting a uniform base before varnishing or painting.

## APPLICATION

The non-rebated adjustable door frame with Estetic 80 hinges is applicable to all DRE collections in the non-rebated turn-only version with Estetic 80 hinges.

## CONTENT OF THE SET

Main beam (horizontal and two vertical elements) with a wide angle bar (80 mm) with small rounding radii of the cross-sectional profile (R2), door gasket, set of hinges, set of elements for assembling the door frame according to the attached manual. Door frames are packed in cardboard packaging.

Cross-section of ORB 095-300

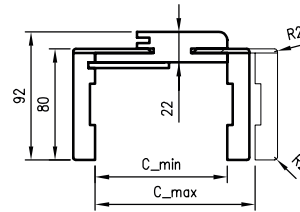

Section of ORB 075

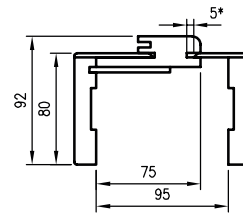

\* The 075-095 door frame has a different cross-section, for a wall thickness of 75-89 mm it will be necessary to shorten the tongue of the movable angle bar on your own.

### Wall thickness

Cmin	Cmax
75	95
95	115
120	140
140	160
160	180
180	200
200	220
220	240
240	260
260	280
280	300
300	320

ORB 45° connection

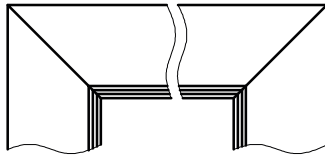

ORB 90° connection\*\*

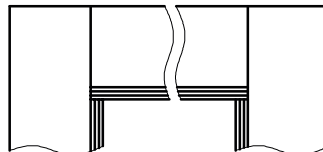

\*\* 90° connection available in white matt, black matt 2, painted white, acrylic UV, white pine, sand oak, Polish 3D oak, white varnish, black varnish and decors from the LUX and WOOD collections.

horizontal section ORB

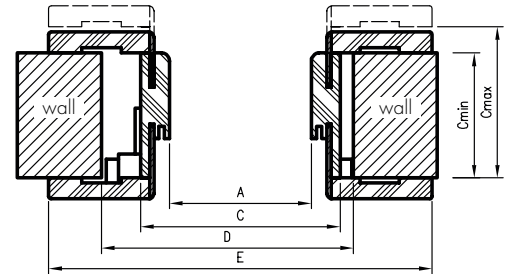

D - required width of wall opening

Vertical cross-section of non-rebated doors in ORB

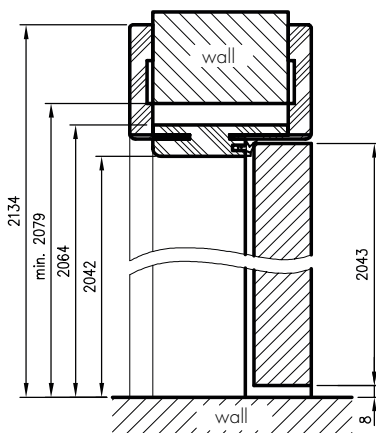

For single-sash doors

	A	C	D	E
"60"	627	671	711	811
"70"	727	771	811	911
"80"	827	871	911	1011
"90"	927	971	1011	1111
"100"	1027	1071	1111	1211

For double-sash doors

	A	C	D	E
"120"	1274	1318	1378	1458
"130"	1374	1418	1478	1558
"140"	1474	1518	1578	1658
"150"	1574	1618	1678	1758
"160"	1674	1718	1778	1858
"170"	1774	1818	1878	1958
"180"	1874	1918	1978	2058

Prices include 2 hinges with fixing plates.

- Price of the door frame for double-sash doors: (additional charge if 3 Estetic 80 hinges are used)

- Surcharge for the third Estetic 80 hinge

- Surcharge for 90° connection angle in white matt, black matt 2, white UV acrylic varnish, white pine, sand oak, Polish 3D oak.

# ADJUSTABLE FRAMES

NON-REBATED WITH VARIABLE HEIGHTS

## APPLICATION

Non-rebated adjustable door frame with variable heights can be used with non-rebated door sashes Standard 10, Modern, Plus in three additional door sash height options: 1983 mm, 2110 mm and 2240 mm

## CONTENT OF THE SET

Main beam (horizontal and two vertical elements together with masking elements), door gasket, set of hinges, set of elements for assembling the door frame according to the enclosed instructions.

Door frames are packed in cardboard packaging.

All door frames in 3 additional height options can be equipped with 2 or 3 hinges.

**\* NOTE:** the 075-095 door frame has a different cross-section, for a wall thickness of 75-89 mm it will be necessary to shorten the tongue of the movable angle bracket on your own

Cross-section of ORB 095-300

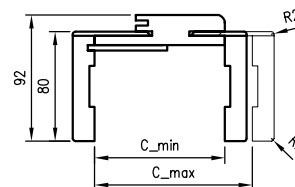

Cross-section of ORB 075

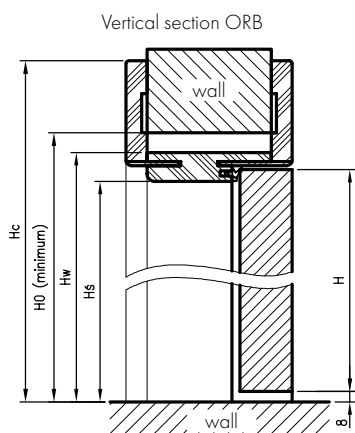
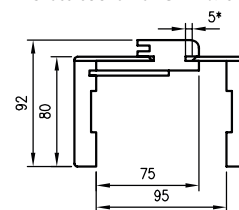

Horizontal section ORB

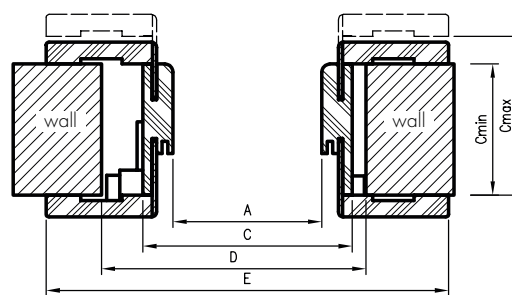

Wall thickness	
Cmin	Cmax
75	95
95	115
120	140
140	160
160	180
180	200
200	220
220	240
240	260
260	280
280	300
300	320

H	Hs	Hw	H0	Hc
1983	1982	2004	2019	2074
2110	2109	2131	2146	2201
2240	2239	2261	2276	2331

H0 – required height of wall opening

For single-sash doors

	A	C	D	E
"60"	627	671	771	811
"70"	727	771	811	911
"80"	827	871	911	1011
"90"	927	971	1011	1111
"100"	1027	1071	1111	1211

For double-sash doors

	A	C	D	E
"120"	1274	1318	1378	1458
"130"	1374	1418	1478	1558
"140"	1474	1518	1578	1658
"150"	1574	1618	1678	1758
"160"	1674	1718	1778	1858
"170"	1774	1818	1878	1958
"180"	1874	1918	1978	2058

D - required width of wall opening

Prices include 2 hinges with fixing plates.

– Price of the door frame for double-sash doors: (additional charge if 3 Estetic 80 hinges are used)

– Surcharge for the third Estetic 80 hinge

# ADJUSTABLE FRAMES

FOR DOOR WITH REVERSED REBATE

## CONSTRUCTION

Adjustable door frame with inverted rebate is made of high-quality wood-based board. From the display side, it is painted with the highest quality acrylic UV varnishes. To ensure high quality of painted door frames, they are covered with a special material that forms a uniform base before painting. Its construction is adapted to the sash thickness of 40 mm and allows it to be used for walls with a thickness of 90 - 290 mm.

## APPLICATION

The door frame is applicable to doors with inverted rebate, from the collections: Uni, Binio, Fargo.

## CONTENT OF THE SET

Main beam (horizontal and two vertical elements), T80 angle bar (horizontal and two vertical elements), door gasket, set of two Estetic 1821 hinges, magnetic lock striker, set of elements for assembling the door frame according to the attached manual. Door frames are packed in cardboard packaging.

For single-sash doors

	A	C	D	E	F	S
"60"	625	694	724	885	834	644
"70"	725	794	824	985	934	744
"80"	825	894	924	1085	1034	844
"90"	925	994	1024	1185	1134	944
"100"	1025	1094	1124	1285	1234	1044

## DECOR



white UV acrylic varnish - RAL 9003

ecru - RAL 9001

latte - Flugger 4362, NCS S1505-Y50R

ashen - RAL 7035

Wall thickness	
Cmin	Cmax
90	110
110	130
130	150
150	170
170	190
190	210
210	230
230	250
250	270
270	290

Cross-section of ościeżnicy

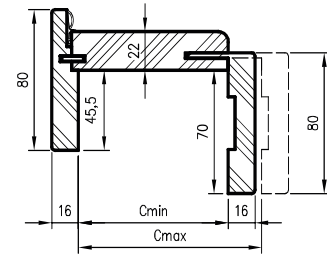

Cross-section of ORO

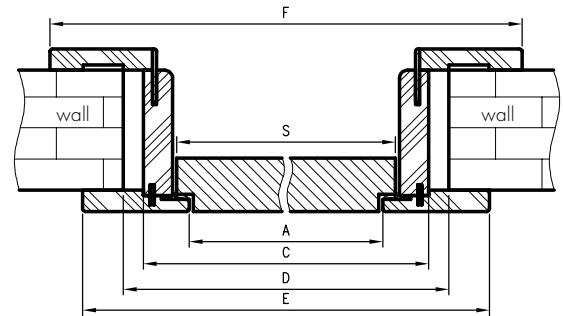

Vertical section ORO

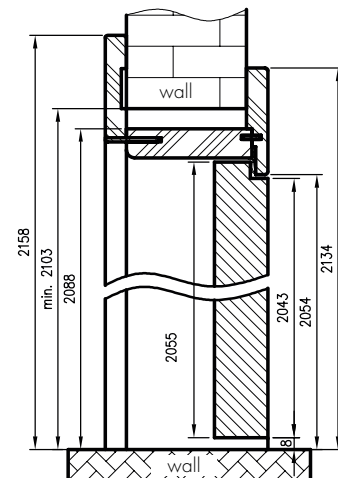

# ADJUSTABLE TUNNEL

WITH ANGLE T63, T80

An adjustable tunnel is a decorative construction of a passage in the wall. It can be used as a stand-alone solution or as an integral part of the NT wall-mounted sliding system.

The adjustable tunnel is a product visually similar to the adjustable door frame, with a few differences:

- no possibility to install hinges
- no catch plate
- no milling for the gasket, different height and span of the front and rear angle bars (value E and F in the tables)

**OPTIONS AT EXTRA CHARGE:** double door tunnel.

**\* NOTE:** In order to ensure high quality of painted tunnels, they are covered with a special material constituting a uniform base before painting.

TUN section with angle. T80

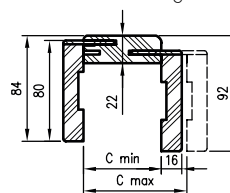

TUN section with angle. T63

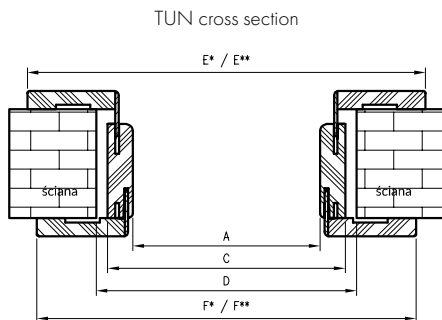
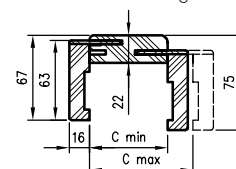

Vertical section of the adjustable tunnel with an angle. T80

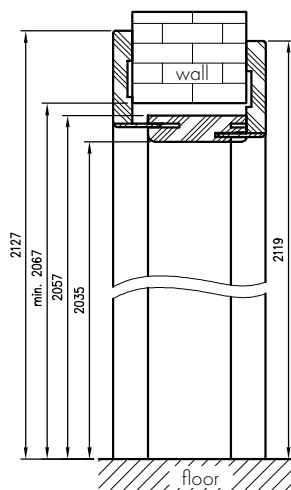

Vertical section of the adjustable tunnel with an angle. T63

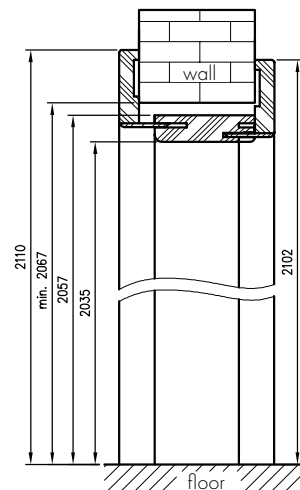

Symbol	60	70	80	90	100
A	602	702	802	902	1002
C	646	746	846	946	1046
D	664	764	864	964	1064
E*	752	852	952	1052	1152
E**	786	886	986	1086	1186
F*	736	836	936	1036	1136
F**	770	870	970	1070	1170

Symbol	120	130	140	150	160	170	180	190	200
A	1200	1300	1400	1500	1600	1700	1800	1900	2000
C	1244	1344	1444	1544	1644	1744	1844	1944	2044
D	1264	1364	1464	1564	1664	1764	1864	1964	2064
E*	1350	1450	1550	1650	1750	1850	1950	2050	2150
E**	1384	1484	1584	1684	1784	1884	1984	2084	2184
F*	1334	1434	1534	1634	1734	1834	1934	2034	2134
F**	1368	1468	1568	1668	1768	1868	1968	2068	2168

Wall thickness

Cmin	Cmax
62	82
82	102
107	127
127	147
147	167
167	187
187	207
207	227
227	247
247	267
267	287
287	307



# SARA ECO 2

REBATED AND NON-REBATED DOOR SASHES - INTERIOR INTERIOR



SARA ECO 2, CARLO satin handle

**PL**

PL Standard

**SK**

SK Standard

## SOLUTIONS **AVAILABLE**



## NON-REBATED - OPENING OUTWARD REBATED - OPENING INWARD

The Sara Eco 2 door is an innovative solution that allows for creative interior design, using invisible doors, giving the option of finishing the sash surface in the colours of the walls.

### THE CONSTRUCTION OF THE SARA ECO 2 DOOR INCLUDES

Aluminium frame, invisible after installation, embedded in the frame or covered with plasterboards. After masonry processing, only the frame notch is visible, ready for painting, e.g. in the colour of the walls.

Non-rebated plate door sash in two finishing options:

- Wide sash surfaces primed and ready for painting or wallpapering (e.g. in the colour of the walls). The edges of the sash are covered with a border that allows it to be painted. Painting should be done on your own or choose painted decors.
- Wide surfaces of the sash covered with foils from the DRE-Cell group, 3D or foil for painting in the group of painted decors, the edges of the sash covered with a rim in the colour of the foil (except antique copper and concrete oxide colours).

## NON-REBATED

- Softwood frame.
- Sockets for 3 or 4 ISTAR recessed hinges.
- Honeycomb filling.
- White or steel magnetic lock for a regular key, bathroom lock, cylinder lock or economy lock.

### DECOR DRE-CELL

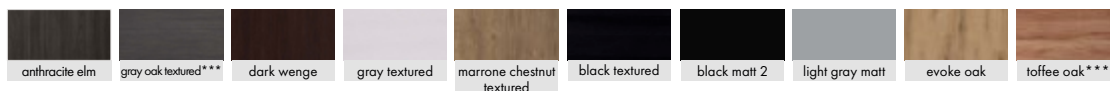

\*\*\* decor only in horizontal graining

**NOTE:** The sashes in white matt are also available in a non-rebated side-by-side version.

### DECOR 3D



### DECOR

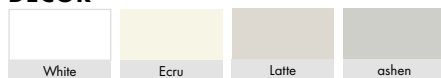

white UV acrylic varnish - RAL 9003  
ecru - RAL 9001  
latte - Flügger 4362, NCS S1505-Y50R  
ashen - RAL 7035

### OPTIONS FOR AN EXTRA CHARGE

- Ventilation undercut.
- Perforated chipboard in the 202 standard.
- Perforated chipboard in the 220 standard.
- Perforated chipboard in the 240 standard.

### ADDITIONAL OPTIONS IN DRE-CELL, 3D AND PAINTED

- Ventilation undercut.
- Plastic ventilation grille.
- Aluminium ventilation grille.
- Drop down gasket.
- Perforated chipboard in the 202 standard.
- Perforated chipboard in the 220 standard.
- Perforated chipboard in the 240 standard.

# SARA ECO 2

NON-REBATED - OPEN OUTSIDE 202X, 220X, 240X STANDARD

Cross-section of the Sara Eco2 non-rebated door - opened outwards

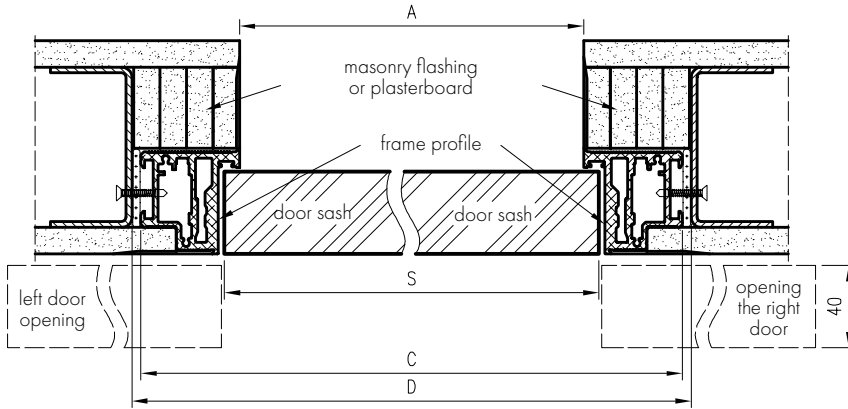

- S - door sash width
- A - clear width of the door frame passage
- C - outer width of the frame
- D - required width of the opening in the wall

Vertical section of the Sara Eco 2 non-rebated door - opened outwards

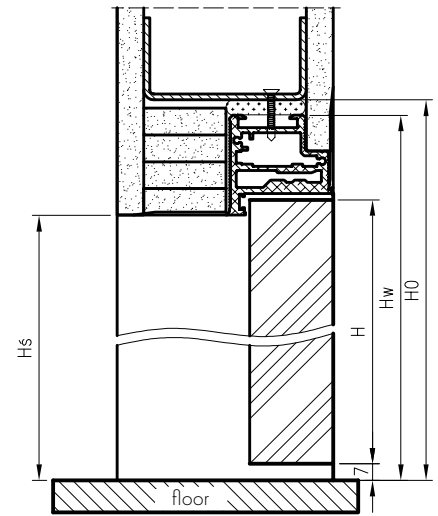

- H - Sash door height
- Hs - clear height of the door frame passage
- Hw - external height of the frame
- H0 - height of the mounting hole

Dimensions of the height of non-rebated doors

norma	H	Hs	Hw	H0
202X	2020	2020	2068	2075
220X	2200	2200	2248	2255
240X	2400	2400	2448	2455

Sara Eco 2 door width dimensions

	S	A	C	D
"60"	620	605	701	710
"70"	720	705	801	810
"80"	820	805	901	910
"90"	920	905	1001	1010
"100"	1020	1005	1101	1110

# SARA ECO 2

REBATED - OPENING INWARDS STANDARD 202X, 220X, 240X

Cross-section of the Sara Eco2 rebated door - opening inwards

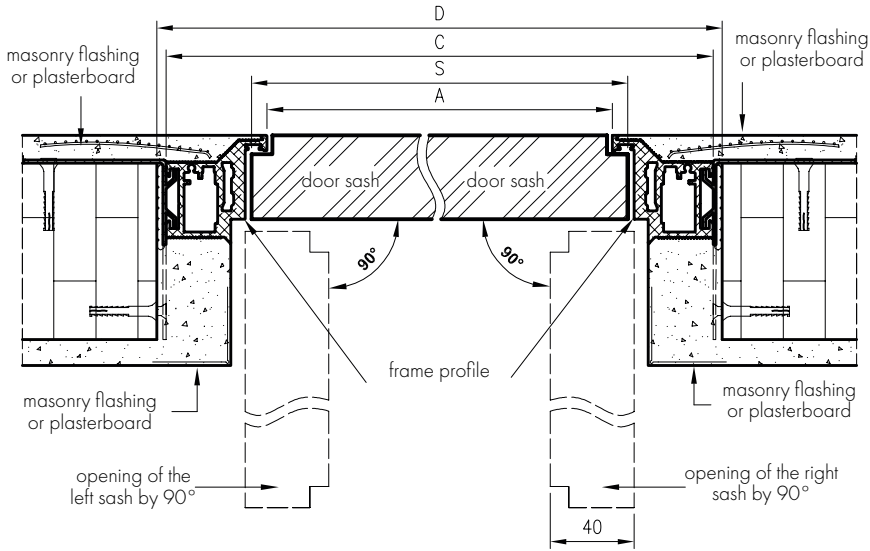

S - door sash width  
 A - clear width of the door frame passage  
 C - outer width of the frame  
 D - required width of the opening in the wall

Cross-section of the Sara Eco2 rebated door - opening inwards

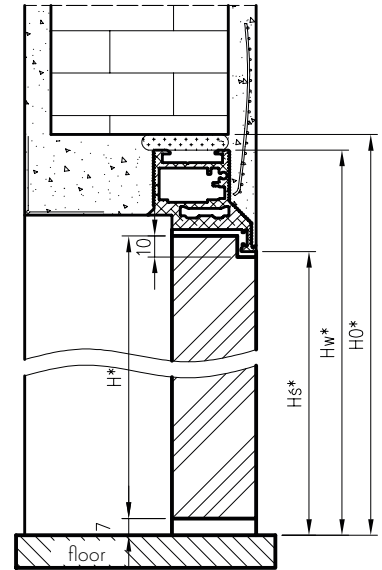

H - Sash door height  
 Hs\* - clear height of the door frame passage  
 Hw\* - external height of the frame  
 H0\* - height of the mounting hole

Dimensions of the height of non-rebated doors

norma	H*	Hs*	Hw*	H0*
202X	2030	2030	2058	2085
220X	2210	2210	2258	2265
240X	2410	2410	2458	2465

\* - Applies to rebate doors

Sara Eco 2 door width dimensions

	S	A	C	D
"60"	620	605	701	710
"70"	720	705	801	810
"80"	820	805	901	910
"90"	920	905	1001	1010
"100"	1020	1005	1101	1110

# ENTER AKUSTIK RW 32 DB

INTERNAL ENTRANCE DOOR

DRE



ENTER AKUSTIK 32dB, LUNA handle brushed chrome

## APPLICATION

Enter Akustik internal entrance doors are intended for use in public and residential construction as internal and internal entrance doors to the extent resulting from the door's functional properties

## IN STANDARD

- MDF board frame reinforced with two steel flat bars.
- Filling perforated chipboard.
- Flat HDF outer panel.
- Drop down gasket.
- 3 silver screw-in hinges.
- R2.5mm edge (only available in CPL laminates) or Straight edge.
- Bottom bolt lock for cylinder insert.
- The door is available in the investment dimension "90E" (clearance in the door frame with the door sash open at an angle of 90 degrees = 900 mm).

## OPTIONS AT EXTRA CHARGE

- Viewfinder - included separately

## DOOR FRAMES

- Simple rebated door frame.
- Adjustable door frame with T80, T63 angle bar.
- Adjustable steel door frame.

### DECOR DRE-CELL 1



### DECOR DRE-CELL 2

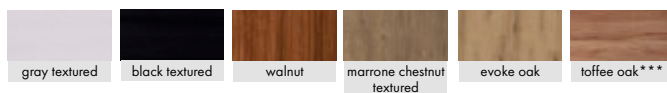

NOTE: The sashes in white matt are also available in a non-rebated side-by-side version.

\*\*\* decor only in horizontal graining

### DECOR 3D

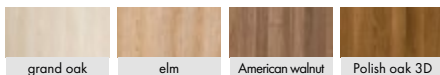

### LAMINATE CPL



Sash width: single sash "70"±"100".

PL

PL Standard

SK

SK Standard

# ADJUSTABLE STEEL FRAMES

The essence of the adjustable door frame is that it enables the final development of the door frame, without the need to perform masonry work. Extending the closing angle of the door frame allows adjustment in the range of +30mm to the Enter Akustik door.

## CONSTRUCTION

The steel door frames are made of 1.5 mm thick low-carbon steel sheet, powder coated. The door frame consists of two stands: a catch and a hinge (in a double-sash door frame both hinge stands) and a lintel, permanently connected with each other by welding.

Hinged racks are equipped with hinge sockets, while bolt keeper racks have cutouts for the tongue and latches of the dedicated door sash lock (the set includes a cover gasket).

The outer and inner side of the door frame is protected with a varnish, organic protective layer. The profile of the door frame, its dimensions and equipment depend on the selected variant - the type of door to which the door frame is to be used.

Width symbol	A	D	E
"60"	600	690	719
"70"	700	790	819
"80"	800	890	919
"90"	900	990	1019
"90E" ****	904	994	1023
"100"	1000	1090	1119
"110"	1100	1190	1219

## IN STANDARD

- Sockets on 3 hinges
- Main lock striker socket

## COLOUR

Door frames are powder coated in two gloss levels: matt/fine; textured or semi-gloss/smooth, available in the following colours:



## STEEL ADJUSTABLE REBATED DOOR FRAMES - DIMENSIONS

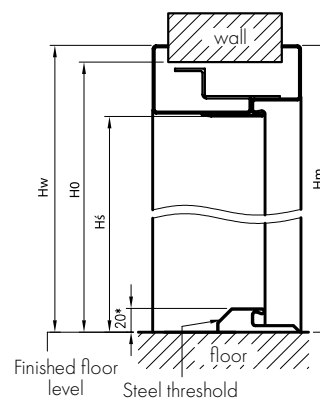
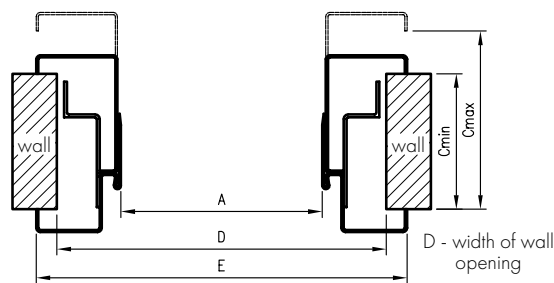

Frame type	H0	Hs	Hw	Hm	W
OSR ENTER	2073	2027,5*	2088	2087	30

Wall thickness	
Cmin	Cmax
95	125
125	155
155	185
185	215
215	245
245	275
275	305

# STRAIGHT REBATED DOOR FRAMES

## CONSTRUCTION

The straight door frame is made of high-quality wood-based panels and covered with ecological, wood-like DRE-Cell decorative foil, 3D foil, CPL laminate 0.15 - 0.2 mm. The door frame has a fixed width of 100 mm.

## APPLICATION

The straight door frame is applicable to the ENTER entrance door (equipped with 3 hinges  $\varnothing$  13.5 mm and an additional upper bolt keeper)

We use masking bands for the straight and straight SOFT door frames and masking angles for the straight SOFT door frame.

## CONTENT OF THE SET

Main beam (horizontal element and two vertical elements), door gasket, set of hinges, set of elements for assembling the door frame acc. attached manual. Door frames are packed in cardboard packaging.

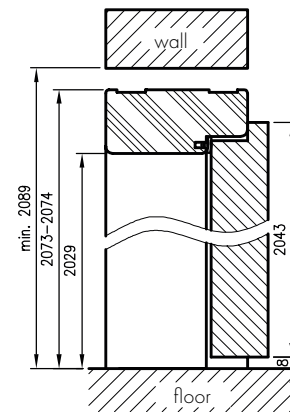
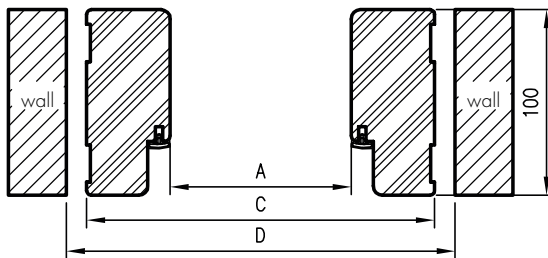
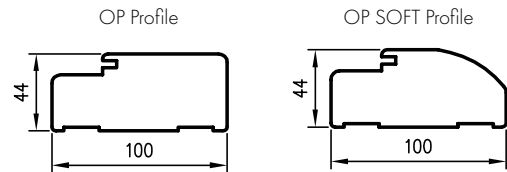

Dimensions for single-sash doors

	A	C	D
"60"	600	688	712
"70"	700	788	812
"80"	800	888	912
"90"	900	988	1012
"90E"	904	992	1016
"100"	1000	1088	1112

# ADJUSTABLE FRAMES

WITH ANGLE T80 OR T63

## CONSTRUCTION

The adjustable door frame with the T80 or T63 angle bar is equipped with angle bars with small rounding radii of the transverse profile. It is made of high-quality wood-based board.

From the display side, it is covered entirely with a wood-like decorative DRE-Cell Decor foil, 3D foil, CPL laminate, thickness. 0.15 - 0.2mm or it is painted\*. Its design allows it to be used for walls with a thickness of 60 - 320 mm.

\*\* In order to ensure high quality of painted door frames, they are covered with a special material constituting a uniform base before varnishing.

## APPLICATION

The adjustable door frame applies to:

- interior doors - rebated and for glass doors (ORC)
- ENTER entrance door (includes 3 hinges  $\varnothing$  13.5 mm, additional catch)

## CONTENT OF THE SET

Main beam (horizontal and two vertical elements together with masking elements), door gasket, set of hinges, set of elements for assembling the door frame according to the enclosed instructions. Door frames are packed in cardboard packaging.

OR/ORC section with angle.T63

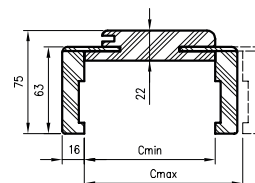

OR/ORC section with angle.T80

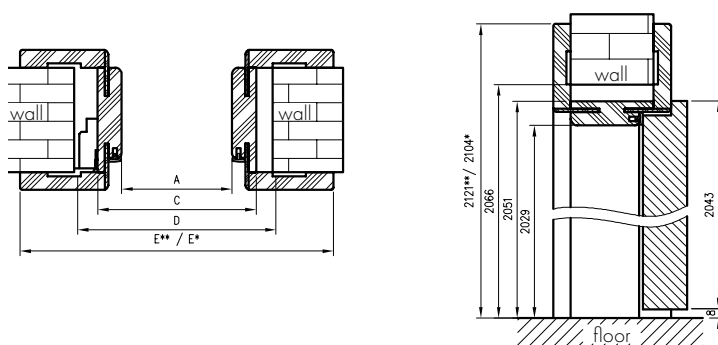
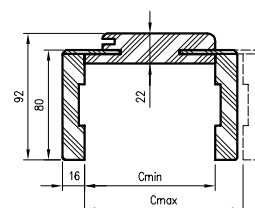

Dimensions for single-sash doors

	A	C	D	E**	E*
"60"	602	646	680	786	752
"70"	702	746	780	886	852
"80"	802	846	880	986	952
"90"	902	946	980	1086	1052
"100"	1002	1046	1080	1186	1152

\* dimension applies to the door frame with the T63 angle bar

\*\* dimension applies to the door frame with the T80 angle bar

Wall thickness	
Cmin	Cmax
60**	75
75	95
95	115
120	140
140	160
160	180
180	200
200	220
220	240
240	260
260	280
280	300
300	320

\*\*\* The door frame for the wall 060-075 has a shallower groove on the side of the movable angle bar, it will be necessary to shorten the tongues of these angle bars during assembly.

# INFINITY LINE HARDWARE

## HANDLES FOR BOARD SASHES, STILES

Apollo Fit **black**

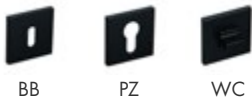

Apollo Fit **chrome**

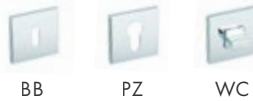

Apollo Fit **matt chrome**

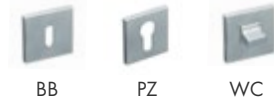

Apollo Fit **titanium**



Apollo Fit **golden**

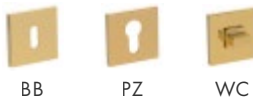

Apollo Fit **gold matt**



Shark **black**



Shark **chrome**

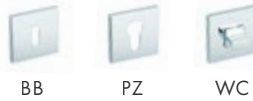

Shark **matt chrome**



Shark **gold matt**

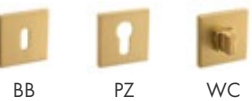

Diamond **black**



Diamond **chrome**

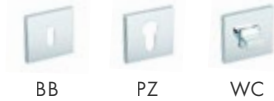

Ice **black**



BB PZ WC

Ice **chrome**



BB PZ WC

Stinger **black**



BB PZ WC

Stinger O **golden**



BB PZ WC

Stinger  **matt chrome**



BB PZ WC

Stinger **titanium**



BB PZ WC

Stinger **golden**



BB PZ WC

Stinger **gold matt**



BB PZ WC

Stinger O **black**



BB PZ WC

Stinger O **golden**



BB PZ WC

Ronda O **black**



BB PZ WC

Ronda O **chrome**



BB PZ WC

Ronda O **golden**



Ronda O **gold matt**



Wenus Fit O **black**

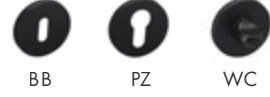

Wenus Fit O **chrome**



Wenus Fit O **golden**



Sky **black**

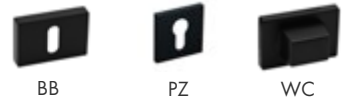

Sky **matt chrome**

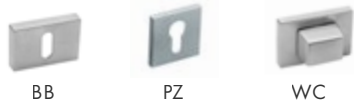

Spectra **black**

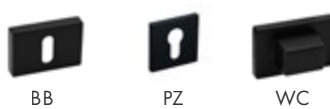

Spectra **matt chrome**



Polo **black**



Polo **matt chrome**



Solo **black**



Solo **matt chrome**



Cavo **black**



Cavo **matt chrome**



Vega **black**



Vega **matt chrome**



Millennium **black**



Millennium **chrome**



Millennium **golden**



Lea **black**



Lea **chrome**



Lea **golden**



Concept Glamour **black**



Concept Glamour **chrome**



Concept **black chrome**



Concept **white chrome**



Concept **white satin**



Nove **chrome**



Nove **matt chrome**

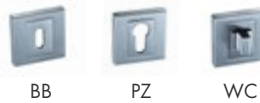

Nove **satin**



Apollo **black**



Apollo **chrome**



Apollo **matt chrome**

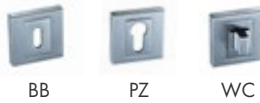

Apollo **titanium**



Apollo **satin**



Carlo **black**

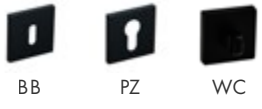

Carlo **satın**



Maxim **black**

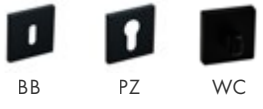

Maxim **satın**



Hermes **black**



Hermes **satın**



Hermes **patina**



Ferrara **black**

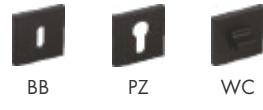

Ferrara **chrome**



Nicola **matt chrome**

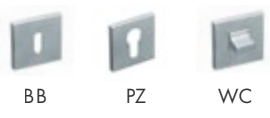

Nicola **black mat**

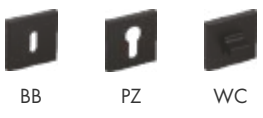

Capri O **golden**



Etna **black**



Etna **matte chrome**



Etna **chrome**

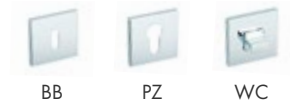

Bali **black**

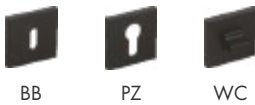

Bali **chrome**

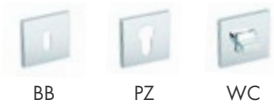

Giulietta **black**



Giulietta **chrome**



Giulietta **matte chrome**



Laura **patina**



Maxim **black**

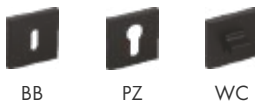

Maxim **satın**



Gemello **black**

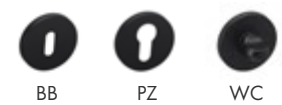

Gemello **black**



Knob **black**

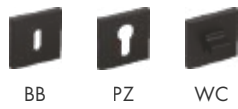

Knob **chrome**

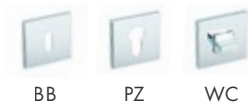

Knob **golden**

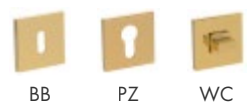

Lena **satın**



Lena **patina**



Lena **black**



Torino **black**



Torino **satın**



Torino **patina**



Hermes KHR **satın**



Hermes KHR **patina**



# METAL-BUD FITTINGS

HANDLES FOR BOARD SASHES, STILES

Luna **Chrome**



Luna **brushed chrome**



Luna **black mat**

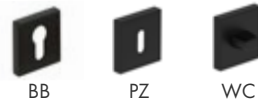

Luna **shiny brass**

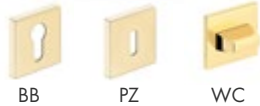

Luna **shiny chrome**



Luna **brushed chrome**



Luna **shiny brass**



Luna **black mat**



Cube slim **shiny chrome**



Cube slim **shiny brass**



Cube **brushed chrome**



Cube **black mat**

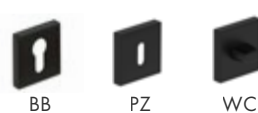

Cube premium **nickel/satin**



Cube **shiny chrome**

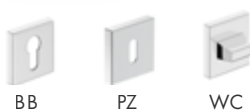

Trend **nickel/satin**



Trend **graphite/chrome**



Trend **shiny chrome**



Deco **medium oak greko**



Deco **walnut greko**



Deco **oak greko**



Deco **sonoma greko**

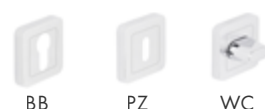

Deco **sanremo greko**



Deco **black**



Deco **white greko**



Ibiza shiny chrome



Ibiza nickel/satin



Ibiza graphite/chrome



Linea shiny chrome



Linea nickel/satin



Linea graphite/chrome



Qubik black mat

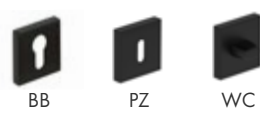

Barcelona nikiel velvet



Barcelona shiny chrome



Barcelona black mat

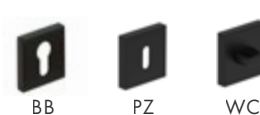

Topaz black mat

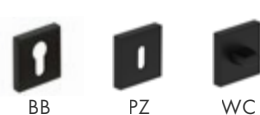

Topaz inox



Nova **inox**



Nova **inox**



Jowisz **inox**



Roma **inox**



Mistico **shiny chrome**



Mistico **brushed chrome**



Erba **nickel/satin**



Erba **antique brass**



Cascada **nickel/satin**



Cascada **antique brass**



Jowisz **inox key**



Jowisz **inox insert**



Jowisz **inox WC**



Jowisz **inox**



Jowisz **inox insert**



Jowisz **inox WC**



Jowisz **inox**



Topaz **inox key**



Topaz **inox WC**



Topaz **inox insert**



Topaz **inox economic**



Astra **nikiel**



Astra **nikiel insert**



Astra **nikiel WC**



Astra **nikiel**



Astra **patina**



Astra **patina insert**



Astra **patina WC**



Astra **patina**



Bonn **inox plus**



Bonn **patina**



Bonn **black**



Essen **nickel/satin**



Essen **patina**



Essen **black mat**



1/2023



Eko-Okna S.A.

ul. Spacerowa 4

47-480 Kornice