

**eko  
OKNA**

**FACADE BLINDS  
CATALOGUE**





# TABLE OF CONTENTS

<b>ABOUT COMPANY</b>	<b>05</b>
<hr/>	
<b>FACADE BLINDS</b>	<b>06</b>
OVERHEAD FACADE BLINDS	<b>08</b>
TOP-MOUNTED FACADE BLINDS	<b>14</b>
SHAPES OF LAMELLAS	<b>20</b>
THE COLOUR OF THE LAMELLAS	<b>22</b>
GUIDES	<b>26</b>
ACCESSORIES AND AUTOMATION	<b>30</b>



## Our company

Our company Eko-Okna S.A. is an international manufacturer of PVC, wooden, aluminium, and steel windows and doors. We have been on the market since 1998. Production takes place in halls equipped with the most modern, fully automated factory lines. The production process is supported by a qualified and experienced workforce. We focus on development and innovation. As the first in Europe, we introduced windows made with V-Perfect profile welding technology to mass sales.

Our range is constantly expanding. Today, we can offer you dozens of different window and door systems. We also offer sliding systems, roller shutters, sectional garage and industrial doors, mosquito nets, fences, and pergolas. As an addition to windows and doors, we offer blinds. We manufacture internal and external blinds, facade blinds, and shutters. All of the highest quality, as we only use high-quality materials from leading European suppliers.

Years of experience allow us to accurately predict demand and respond to customer needs. A fresh look at changing trends allows us to create products that are a complete response to market needs. Multi-million investments in the machine park, experience, and multilingual staff contribute to the growth of our export strength year by year. We effectively expand into European and non-European markets.

The quality of our products and our actions have gained recognition from customers worldwide. So far, we have created a powerful sales network, which we constantly expand.



# FACADE **BLINDS**

A classic solution providing an exceptionally tight barrier against sunlight due to the use of high-quality materials for its construction and the possibility of installation on the external side of the window. In an aesthetic way, they change the appearance of building facades, while their installation slows down heat exchange, allowing for a decrease in temperature inside the building by up to 9°C.



## Overhead **Facade Blinds**

Overhead facade blinds are an optimal solution to the problem of excess light and heat in rooms. The wealth of available aesthetic solutions makes it easy to adapt the appropriate blinds to any building. They can be used when the construction project includes the installation of a box in the lintel. Our aluminium boxes can be used in many systems and are also very versatile.



BASIC



RAFF-I



RAFF-E



SKEF



# Overhead Facade Blind **BASIC**

Basic is a versatile system of facade blinds. The system's versatility is ensured by the adjustment of the upper rail brackets and the adjustment of the guide brackets. This allows for easy installation in most homes - in adaptive and flush-mounted systems. The system's design enables the use of guides, which are installed using brackets and monolithic guides mounted directly to windows.

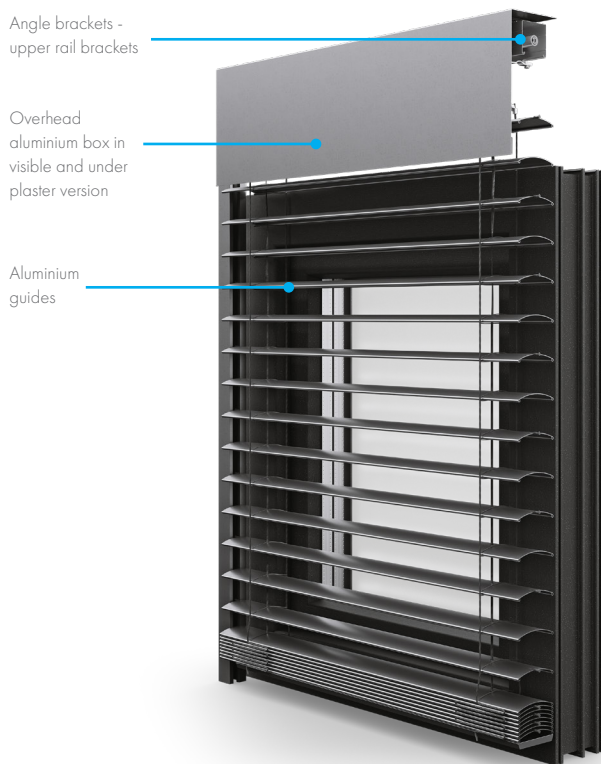

## Lamel shapes:

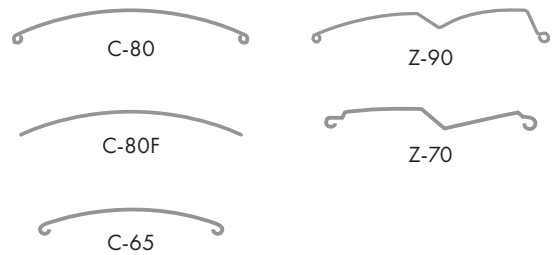

## Blind cover shapes:

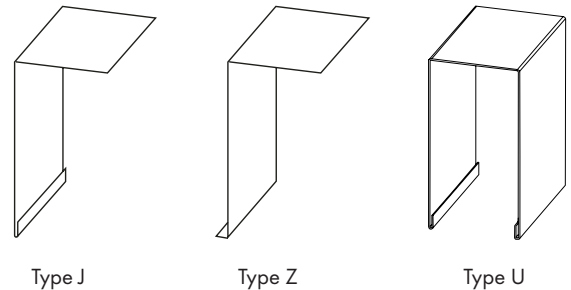

Box shape:  
rectangular ALU



Maximum box width:  
6000 mm



Box size:  
200 x 140 mm  
240 x 140 mm  
300 x 140 mm  
350 x 140 mm



Minimum box width:  
550 mm

# Overhead Facade Blind **RAFF-I**

RAFF-i is a modern system with an aluminium casing, which is mounted either onto the lintel or directly onto the facade. Special pins protrude from the casing, which simply need to be inserted into the previously mounted guides, making the installation of the entire system simple and very fast. The casing with its distinctive embossing, giving it a unique and modern appearance, is available in a visible or concealed version.

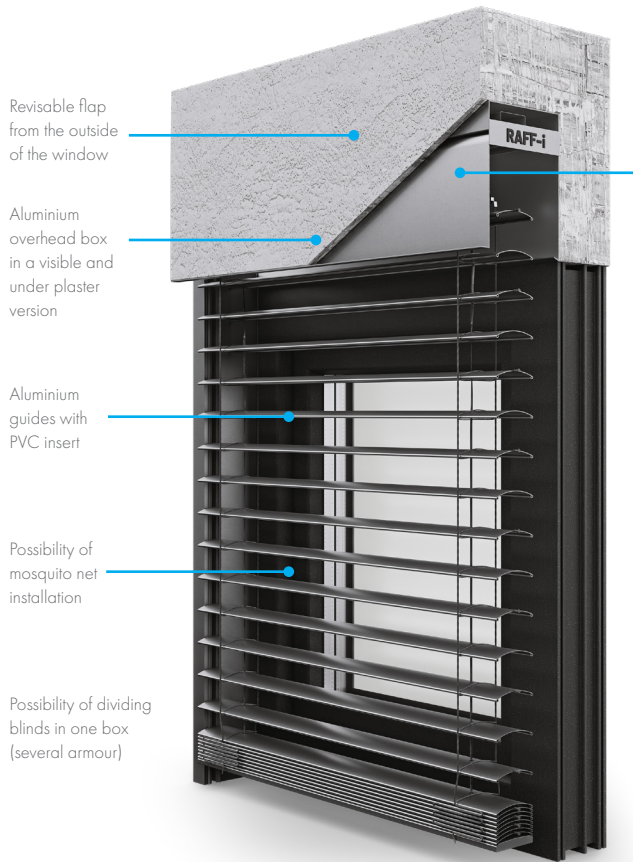

Reversible flap from the outside of the window

Aluminium overhead box in a visible and under plaster version

Aluminium guides with PVC insert

Possibility of mosquito net installation

Possibility of dividing blinds in one box (several armour)

Possibility of setting the box away from the window frame and insulating

## Lamel shapes:

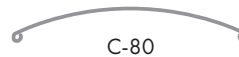

C-80



Z-90



C-80F



Z-70



C-65



Box shape:  
rectangular ALU



Maximum box width:  
6000 mm

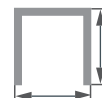

Box size:  
200 x 140 mm  
240 x 140 mm  
300 x 140 mm



Minimum box width:  
560 mm

# Overhead Facade Blind **RAFF-E**

The RAFF-e system is a product designed based on extensive technical knowledge, which makes the blinds easy to measure and their installation efficient and fast.

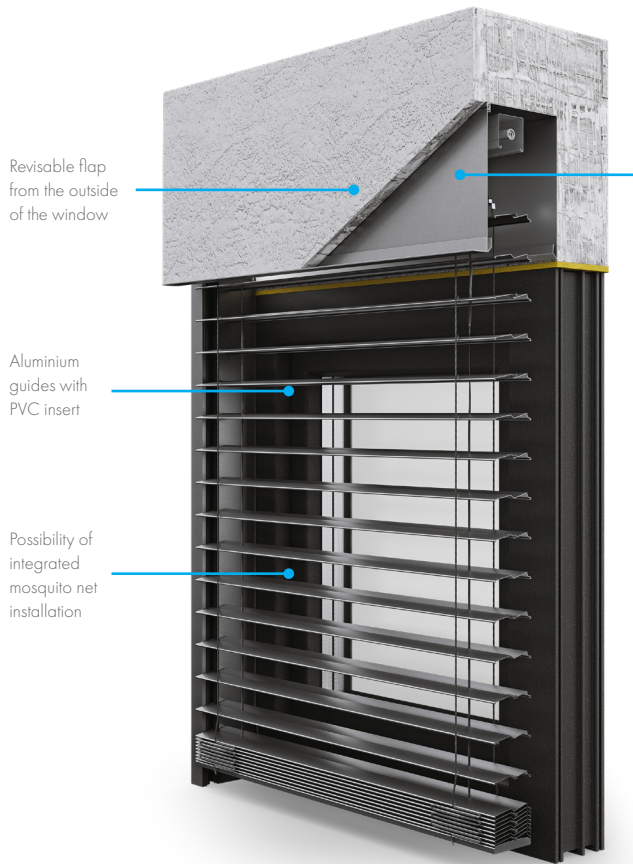

Reversible flap from the outside of the window

Aluminium overhead box in a visible and under plaster version

Aluminium guides with PVC insert

Possibility of integrated mosquito net installation

## Lamel shapes:

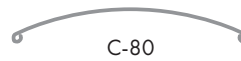

C-80

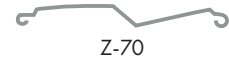

Z-70



C-80F



C-65



Box shape:  
rectangular ALU



Maximum box width:  
4000 mm

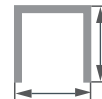

Box size:  
200 x 140 mm  
240 x 140 mm  
300 x 140 mm



Minimum box width:  
560 mm

# Overhead Facade Blind **SKEF**

A system featuring a distinctive casing cut at a 45-degree angle from the outer side. An ideal solution for those who prefer finishing elements with sharp geometric shapes. The casing is designed for installation both directly on the facade of the building and in the window frame recess.

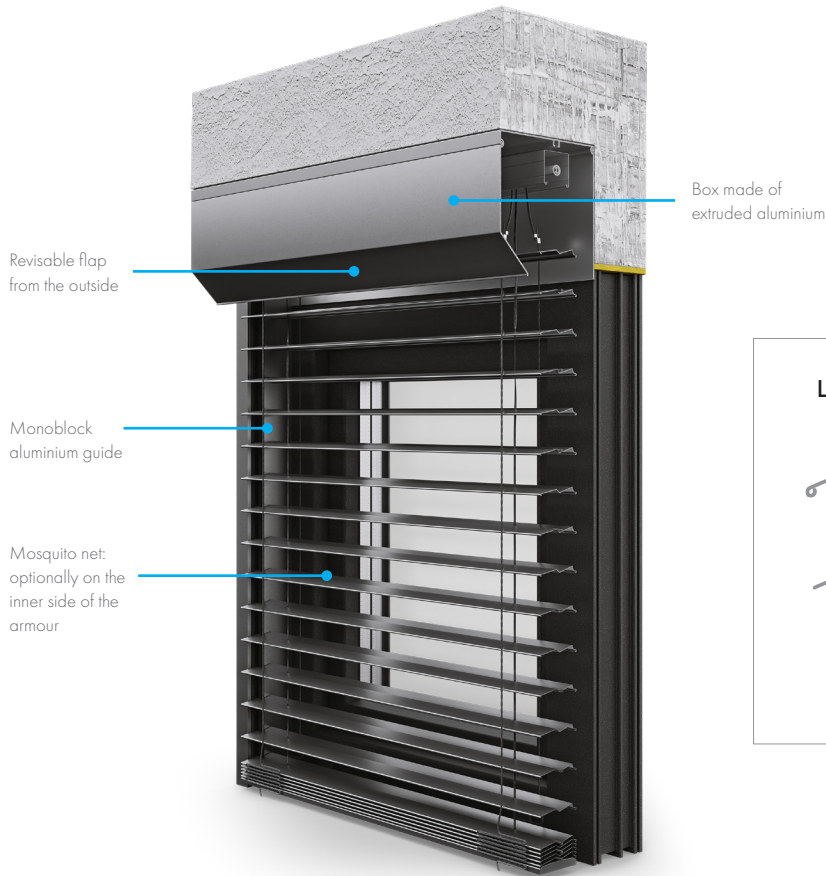

## Lamel shapes:

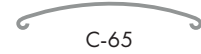
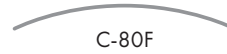
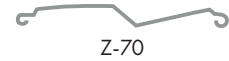
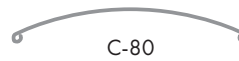

Box shape:  
rectangular ALU



Maximum box width:  
4500 mm



Box size:  
180 x 140 mm  
205 x 140 mm



Minimum box width:  
560 mm

## Top-mounted **Facade Blinds**

Top-mounted facade blinds allow for the adjustment of light and temperature inside a room without the need for complete window blackout. They are available in various configurations, including an option with Z-shaped slats that provide total blackout when necessary. They can be controlled manually, via a radio remote control, or through an integrated Smart Home system. Some models feature insulation in the construction or are built with insulating materials.



ELITE XT



CLEVERBOX



ROKA TOP 2 SHADOW



SKB



# Top-mounted Facade Blind **ELITE XT**

The system's design enables better thermal and acoustic insulation. It saves a significant amount of thermal energy, especially during cooler times of the year. The system is well-known in Western markets, being the only one to offer PVC guides in color or with veneer in the All-in-one system.

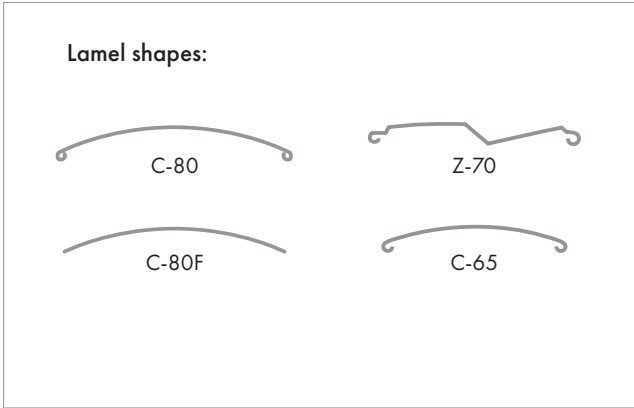
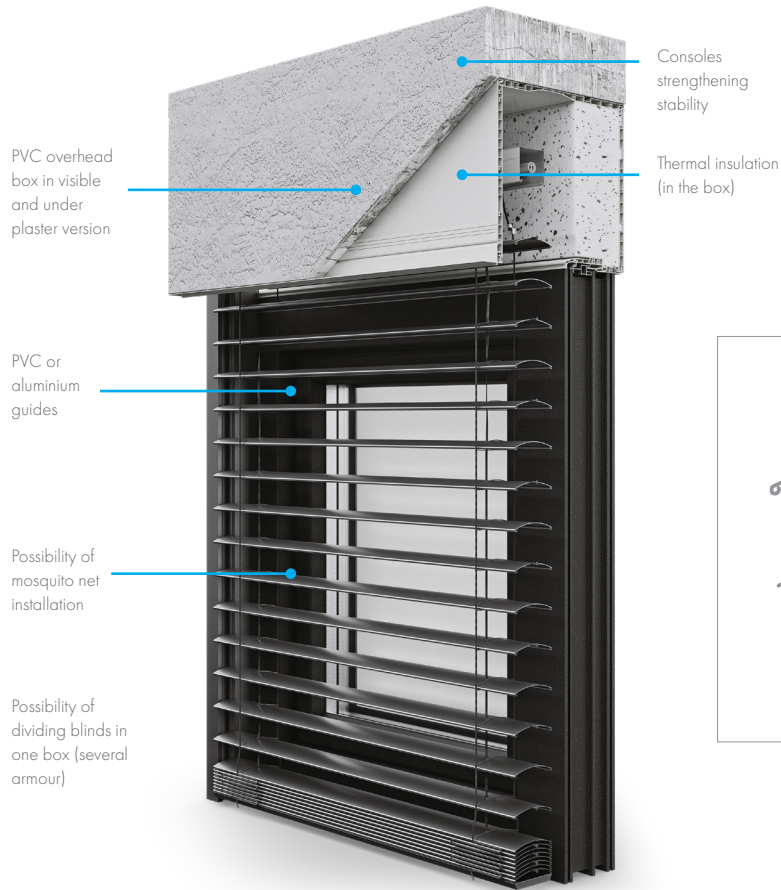

  
**Box shape:**  
 rectangular ALU

  
**MAX**  
 Maximum box width:  
 4500 mm

  
**Box size:**  
 240 x 255 mm

  
**MIN**  
 Minimum box width:  
 630 mm

# Top-mounted Facade Blind **CLEVERBOX**

The system stands out for its best thermal and acoustic insulation parameters, thanks to its unique structure and very high quality of the components used. It is the only overhead system that allows for the use of Z-90 facade blinds, guaranteeing full room darkening. It ensures comfort for users both in summer and winter.

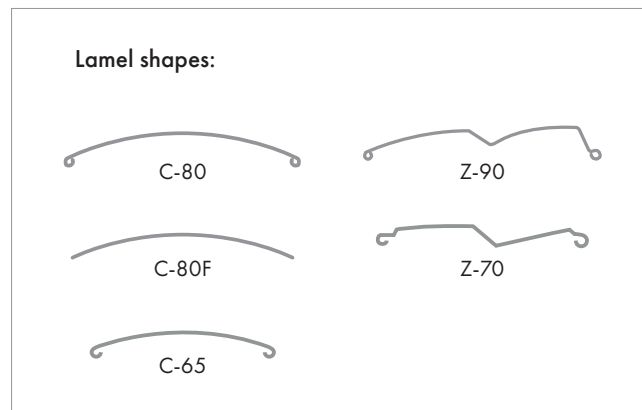
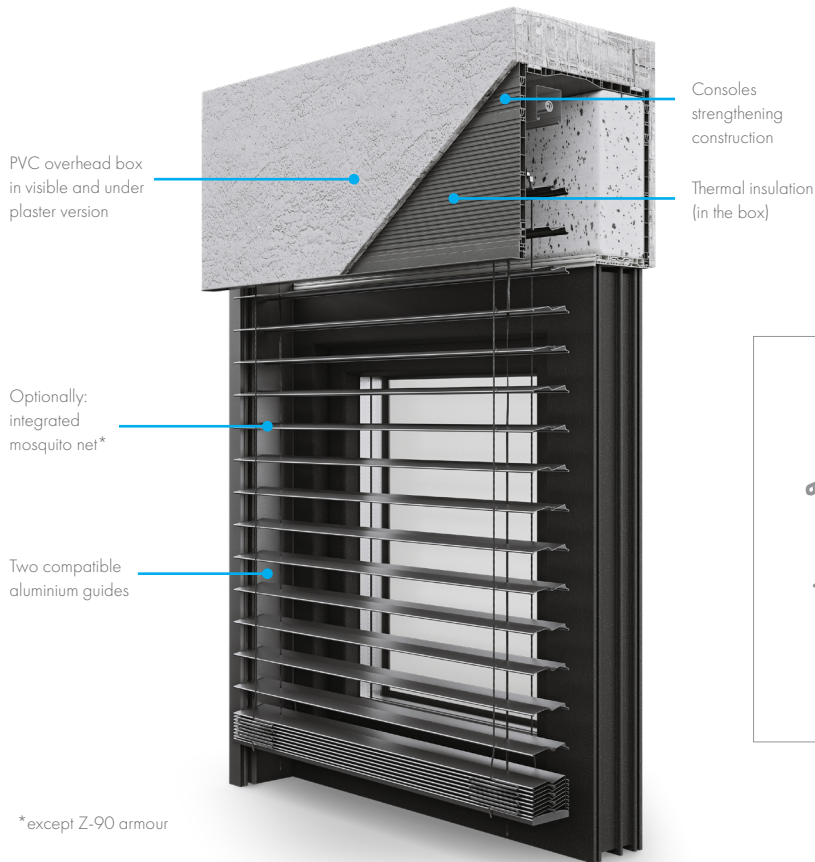

  
**Box shape:**  
 rectangular ALU

  
**Maximum box width:**  
 4500 mm

  
**Box size:**  
 245x 255 mm

  
**Minimum box width:**  
 560 mm

# Top-mounted Facade Blind **ROKA TOP 2 SHADOW**

The combination of Neopor®/Styropor® material with a tight construction results in excellent parameters in terms of protection against sunlight, wind, and moisture. Reinforced along its entire length using embedded steel mesh and additional reinforcements (mounted in stabilizing foam brackets), a construction is created permanently attached to the window and wall. It can be seamlessly integrated with any type of finishing (plaster, External Wall Insulation Systems (EWIS), clinker), creating a cohesive unit with the wall.

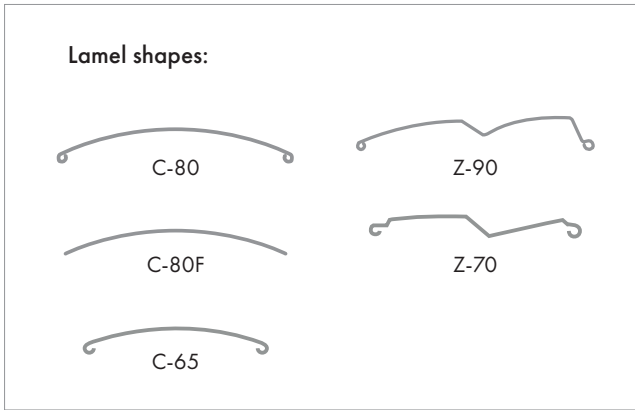
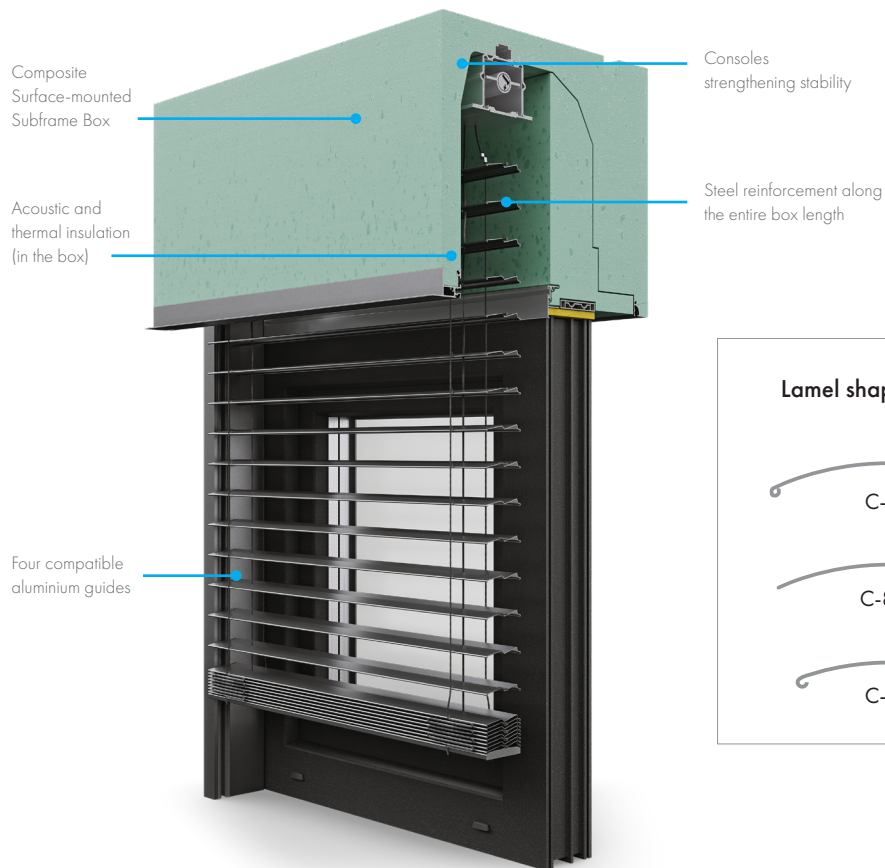

  
**Box shape:**  
 rectangular  
 Neopor®/Styropor®

  
**MAX**  
**Maximum box width:**  
 6000 mm

  
**Box size:**  
 300 x 280 mm  
 300 x 300 mm  
 300 x 345 mm  
 300 x 365 mm

  
**MIN**  
**Minimum box width:**  
 580 mm

# Soffit Facade Blind SKB

The system was primarily created to improve the energy balance of the building. The main component of the system is a box, which is made of high-quality insulation material - styrofoam, which has very good thermal properties.

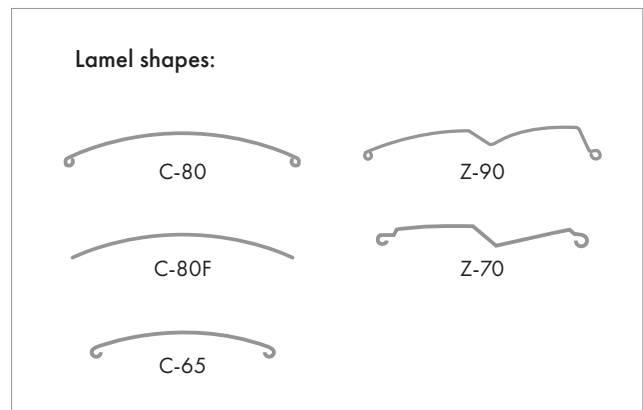
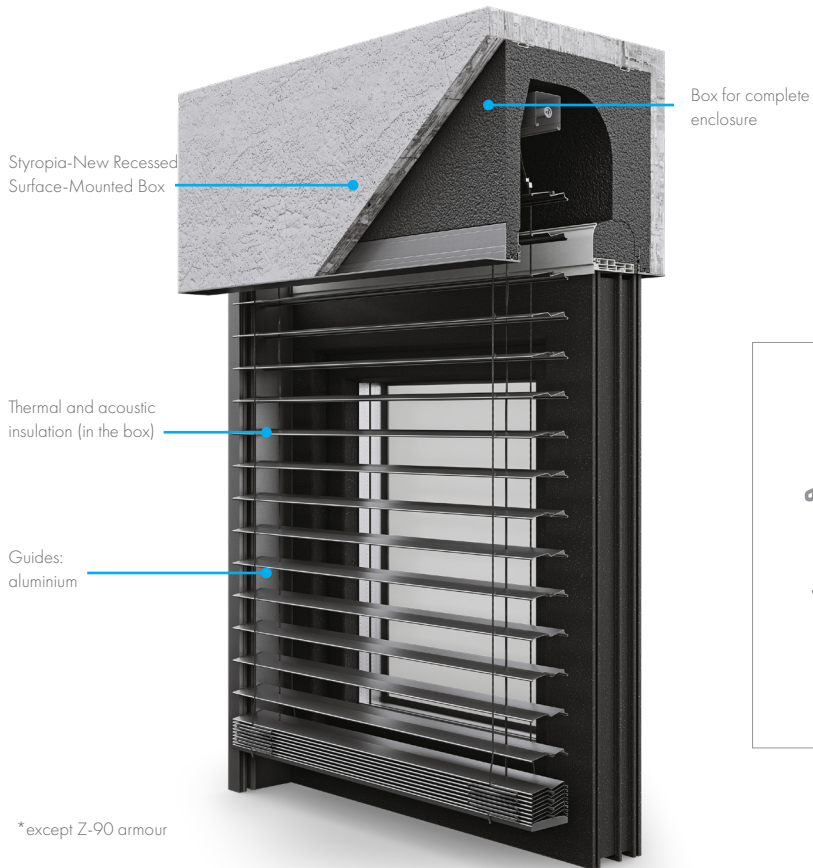

  
**Box shape:**  
 rectangular styrofoam

  
**Maximum box width:**  
 3600 mm

  
**Box size:**  
 260 x 263,6 mm  
 305 x 310,6 mm

  
**Minimum box width:**  
 630 mm

# Shapes of lamellas

The choice of shape and size of lamel is a decision related to both the aesthetics and functionality of the solution. This allows for various degrees of interior darkening, as well as adjusting the height of the package after folding.



## C-80

The C-80 profile allows for the bidirectional rotation of lamel. Constructions based on this type of lamels let in a small amount of light even when closed. They are an optimal solution for those wanting to effectively control the flow of light with the changing position of the sun in the sky.



## C-80 Flat

The C-80 Flat lamel profile is characterised by the lowest package height after folding - rolling up the blinds. Therefore, it is an optimal solution when there is limited space for installing high boxes. The rotation angle of C-80 Flat slats is 90 degrees.



## Z-90

The distinguishing feature of Z-90 profiles is the ability to achieve complete darkening in interior spaces protected by them. This is enabled by their special shape and the presence of sealing, which also reduces the noise produced by lamels moving due to strong gusts of wind.



## Z-70

Z-70 is a more pronounced version of the popular Z-90 solution. This lamellas shape retains all the key advantages of Z slats, including the ability to achieve complete darkening, while reducing the height of the folded roller shutter armour. This allows for the use of lower boxes.



## C-65

C-65 lamellas are one of the most popular products on the market. Their classic shape is consistently valued by customers. The rolled edges improve their static parameters, allowing them to be used on larger glazed areas.





## The colour of the **lamellas**

Guides, bottom rails, and blinds boxes can be painted in any colour from the RAL palette, e.g., to perfectly match the colour of the windows ordered by the customer. However, there is no possibility of such precise colour matching in the case of the slats themselves. They are produced from aluminium strips, which are already coated with paint. During the production of finished slats placed in blinds, they undergo an additional process of applying and curing subsequent layers of paint and clear protective varnishes, which give the product its final shine.



# Z-90

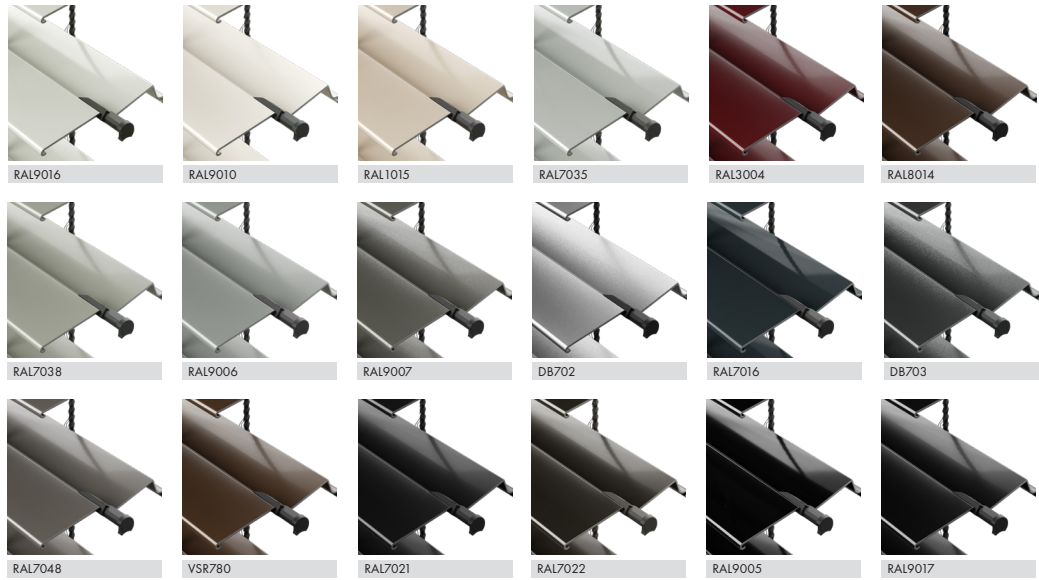

# C-65

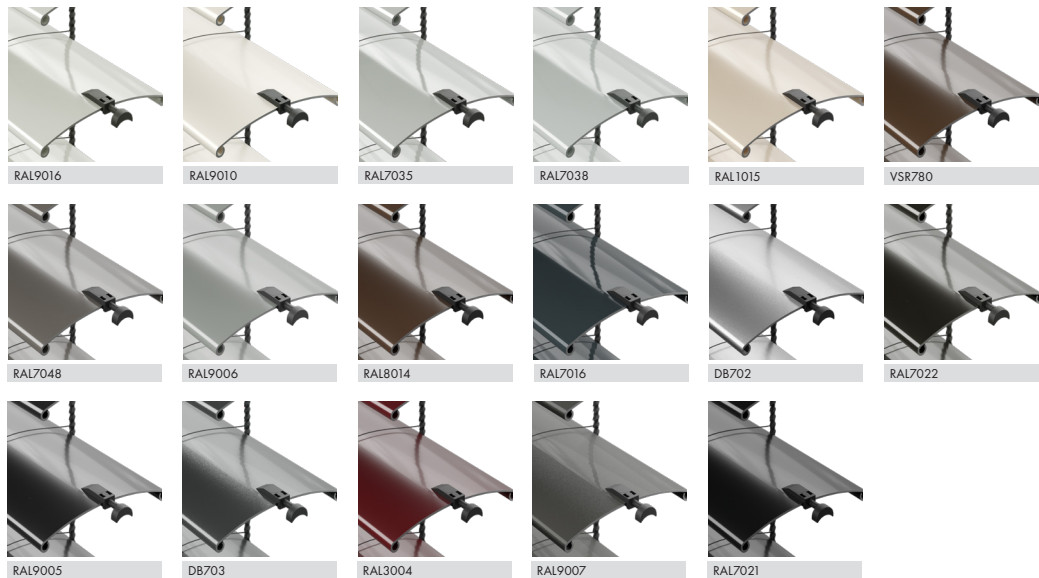

# C-80

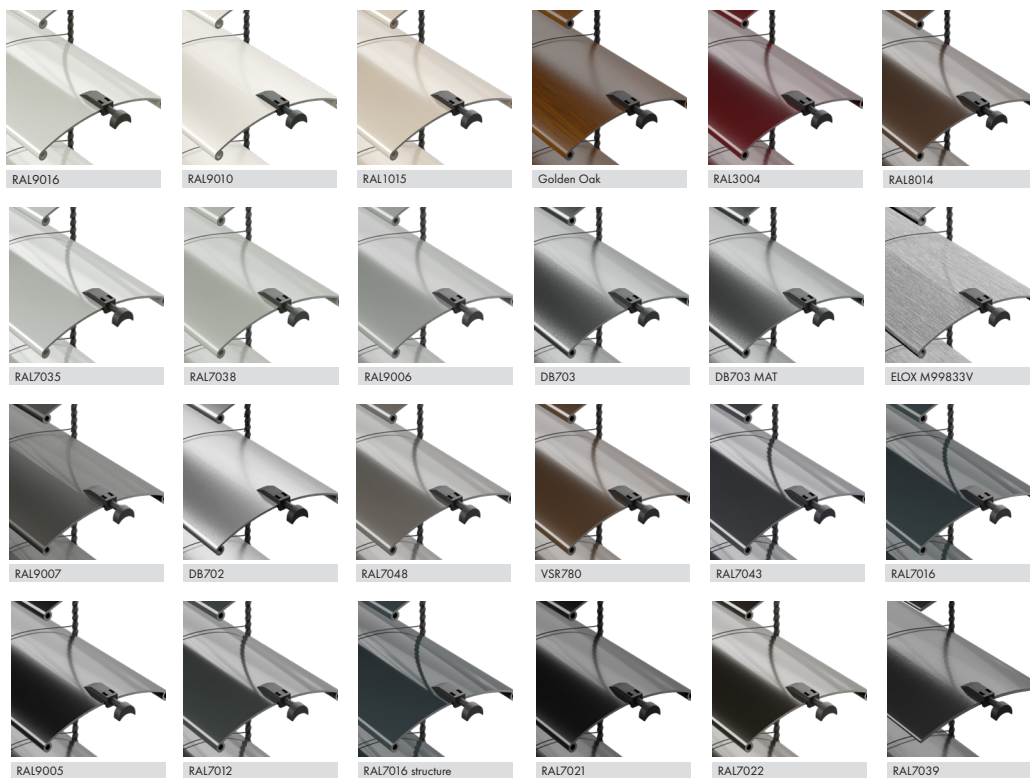

# C-80F

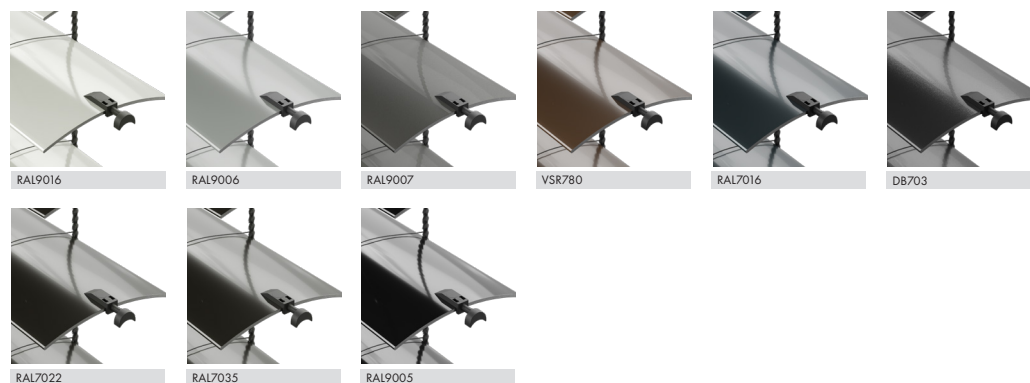

# Z-70



RAL9016



RAL9010



RAL1015



RAL7035



RAL7038



VSR780



RAL7048



RAL9006



DB702

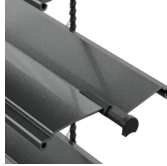

DB703



RAL3004



RAL7016

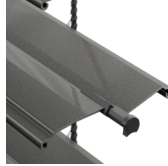

RAL9007



RAL7022



RAL7021



RAL8014



RAL9005

## Guides

The guides of facade blinds are made of aluminium painted in colours from the RAL palette or PVC. They provide stability to the blind's armour. In All-in-One solutions, their aesthetics are matched to the other products included in the package.

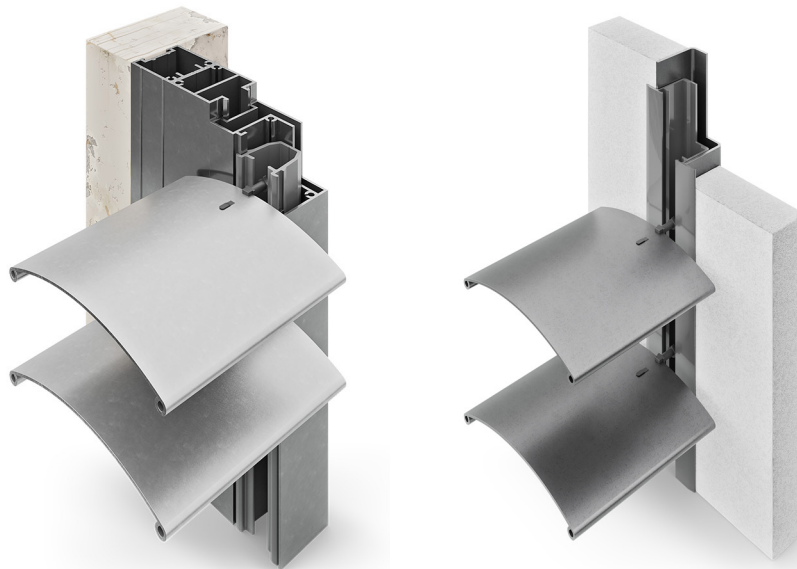

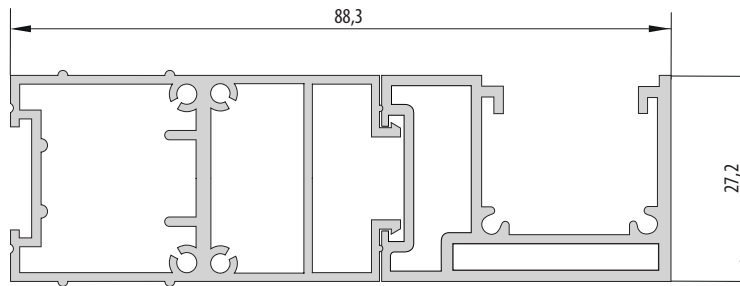

**SOLID monoblock guide**  
 RAFF-e  
 Basic  
 Roka Top 2 Shadow  
 RAFF-i

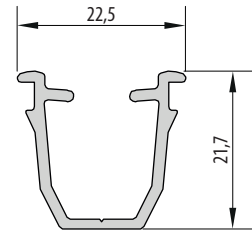

**A40**  
 RAFF-e  
 Basic  
 Roka Top 2 Shadow  
 RAFF-i

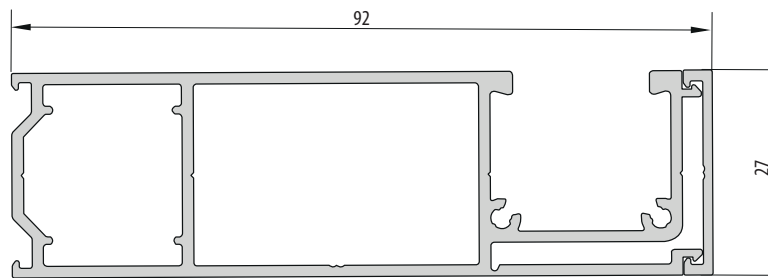

**Eko-Okna monoblock guide**  
 RAFF-e  
 Basic  
 Roka Top 2 Shadow  
 RAFF-i

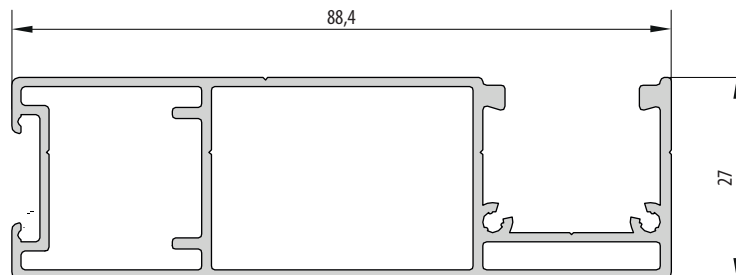

**A45**  
 RAFF-e  
 Basic  
 Roka Top 2 Shadow  
 RAFF-i

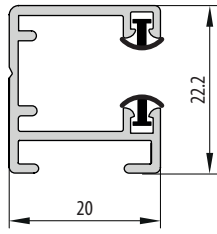

Type 2  
Basic  
Roka Top 2 Shadow  
CleverBox

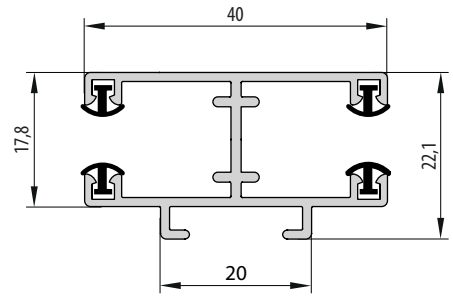

Type 4  
Basic  
Roka Top 2 Shadow  
CleverBox

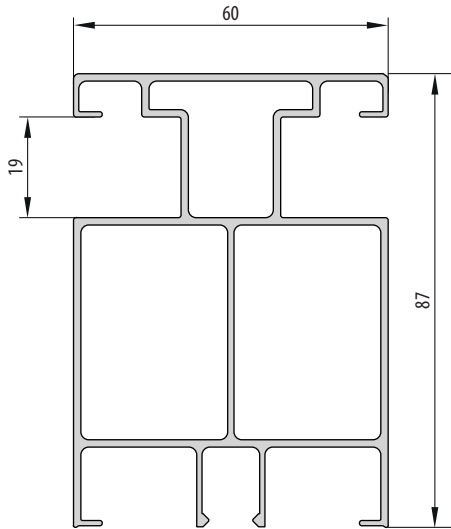

PG10  
CleverBox

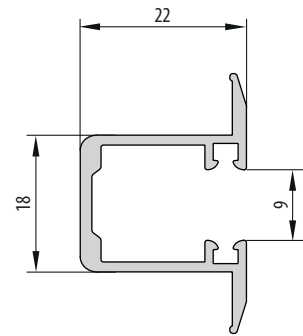

PG12  
CleverBox

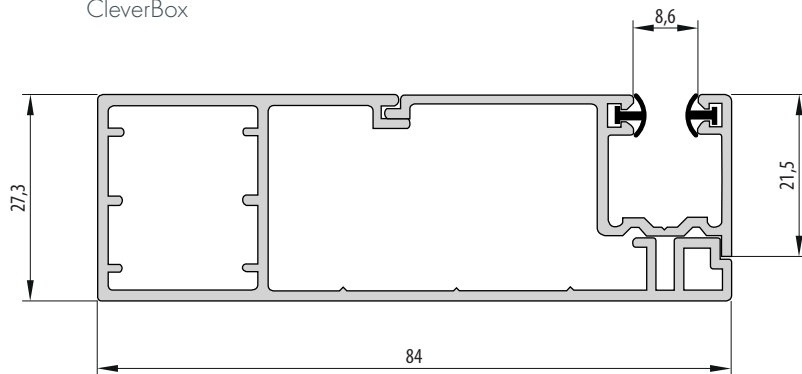

APPF - PPF  
SKEF

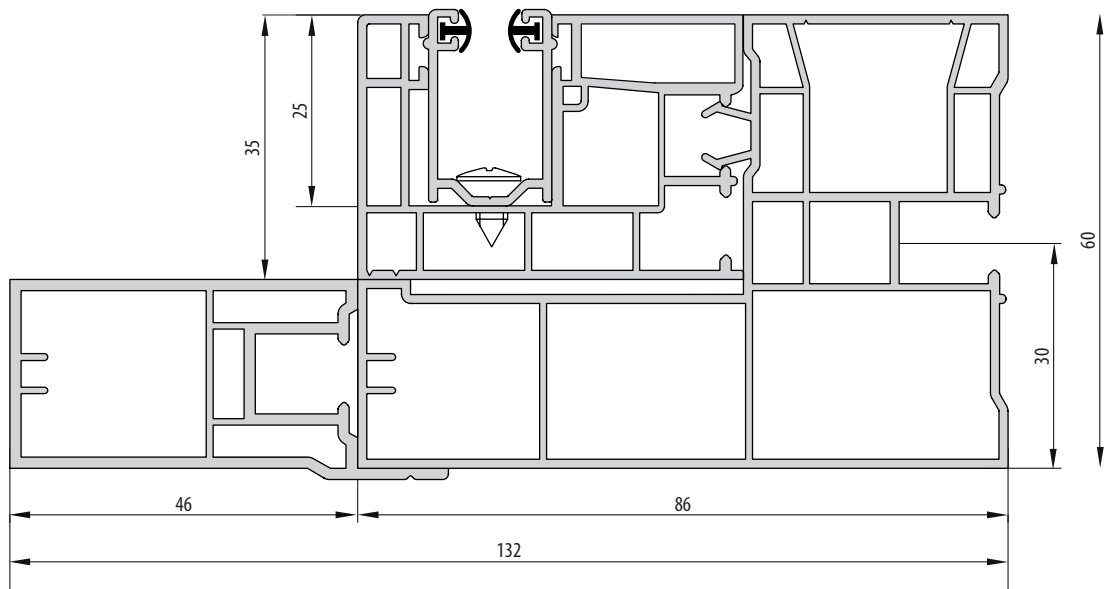

5080 - 5081  
Elite XT

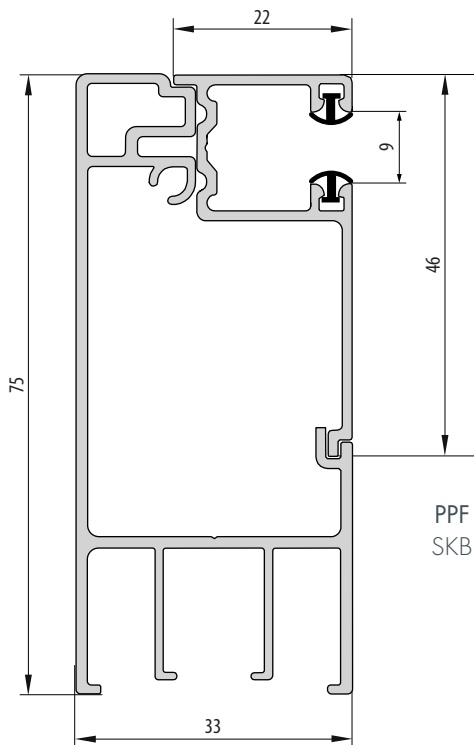

APPF-B\_33  
SKB

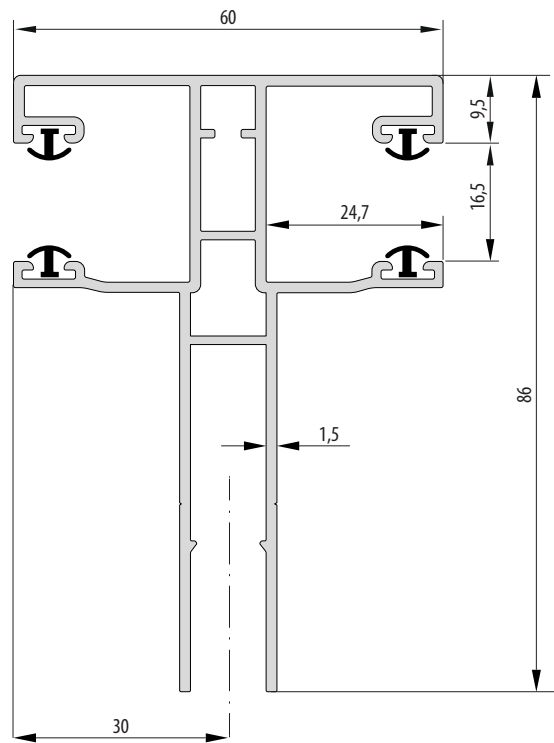

EX 5434  
Elite XT

## Accessories and **Automation**

Facade blinds reach their full potential only after selecting the appropriate accessories and automation. Available options are related to ensuring their safety, smooth regulation, or autonomous operation in response to weather conditions.

Modern control mechanisms, in turn, allow precise control of the blinds, creating scenarios, and managing window coverings from anywhere in the world.

The offer includes all leading brands, especially prestigious Somfy, reliable Geiger, and universal Elero.

The full range of automation for facade blinds is available from sales representatives and on the Eko-Okna website.

### CONTROL **SENSORS**



### REMOTE **CONTROLS**



**somfy**

**Nice**

**e l e r o**  
Sun Shading Solutions Nice

**GEIGER**  
ANTRIEBSTECHNIK



The publication does not constitute a commercial offer. The presented graphic materials are for illustrative purposes only, and the actual colours and textures of the products may differ from those shown in the advertising materials. The graphics presented, including the presentation of colours, cannot constitute the basis for a complaint.

21.11.2024



Eko-Okna S.A.

ul. Spacerowa 4

47-480 Kornice

[www.ekookna.com](http://www.ekookna.com)